



The Grote Performance Advantage™

THE PEOPLE, THE PRODUCTS AND
THE PROGRAMS THAT GIVE YOU
THE COMPETITIVE EDGE

Grote

The first name in vehicle
safety systems®

Trilliant® LED WhiteLight™ Work Lamp

LED

- Long-lasting, high-output LED WhiteLight™ work lamp
- Field tested in brutal off-road applications
- “Aim-N-Go” mounting requires no tools for horizontal adjustments
- Beam pattern can be easily changed with optional replacement lenses that are hard-coated to provides many years of service
- Delivers 35,000 hrs. of operation vs. 2,000 hrs. for HID and 500 hrs. for halogen lamps
- Bright LED WhiteLight™ lamp offers peak intensities of over 150,000 candela
- Durable 1/2” stud mounting bracket makes securing easy
- Toolless adjustments help aim light where needed
- Versatile spot, trapezoid and flood patterns available for application-specific needs
- Unique color temperature provides a natural contrast most like sunlight, reducing eye fatigue and optimizing job performance
- Superior lamp for Utility, Mining, Military, Construction, Agriculture, Tow, Fire, Emergency, Fleet, Off-Road applications and general lighting for environments that requires a durable lamp, delivering a long lasting bright light, that is low heat emitting



LED WhiteLight™ BETTER LIGHT
BETTER PERFORMANCE
INNOVATION by Grote Industries, Inc.



Part Number	Pattern	Light Source	Operating Voltage/AMP
63571	Spot	LED	10V- 30/5.2-1.5A
63671	Spot	LED	24V/2.1A
63581	Flood	LED	10V- 30/5.2-1.5A
63681	Flood	LED	24V/2.1A
63591	Trapezoid	LED	10V- 30/5.2-1.5A
63691	Trapezoid	LED	24V/2.1A
63761	Wide Flood	LED	10V- 30/5.2-1.5A
63771	Wide Flood	LED	24V/2.1A
94580	Replacement Lens-Spot		
94600	Replacement Lens-Flood		
94590	Replacement Lens-Trapezoid		
43652	Adjustable Bracket		

- Adjustable and lockable bracket for the Trilliant™ LED WhiteLight™ lamps
- Gives more aiming control than the standard bracket and additional reliability
- Cantilever locking mechanism stays in place in even the most harsh environment

*“Aim-N-Go” horizontal bracket system is under license from Baja Designs Inc.

Clearance / Marker Lamps

Feux de Gabarit / Position Lámparas de Gálibo / Demarcadora

11-41

Stop / Tail / Turn Lamps

Feux Arrêt / Arrière / Direction Lámparas de Freno / Cuarto / Direccional

42-70

RV, Marine and Utility Trailer Lighting

Phares Nautiques, de Véhicules Récréatifs et de Remorques Lámparas para vehículos Recreativos / Marinos / Utilitarios

71-80

License and Backup

Feux de Plaque d'Immatriculation et de Recul Lámparas de Placa / Reversa

81-90

Interior Lighting

Lumières d'Intérieur Lámparas para Interior

91-104

Forward Lighting

Phares Utilitaires Faros Delanteros

105-126

Warning and Hazard

Gyrophares et Feux d'Avertissement Lámparas de advertencia y precaución

127-149

Flashers and Turn Signal Switches

Clignotants et Commutateurs Palancas Direccionales / Destelladores

150-161

Mirrors

Rétroviseurs Espejos

162-175

Trailer Wiring and Communications Systems

Systèmes de Communication et Filage de Remorques Sistemas de arneses para remolque / Caja de conexión

176-183

Pigtails, Brackets and Grommets

Spirales de Raccord, Bague de Montage et Supports Conectores / Soportes rígidos y flexibles

184-211

Reflectors

Réfecteurs Reflectantes

212-216

Lenses

Lentilles Micas

217-228

Tools and Repair

Outils et réparation Herramientas y accesorios para reparaciones eléctricas

229-235

Military Lighting

Éclairage pour usage militaire Lámparas para uso militar

236-239

European Approved Lighting

Éclairage Européen Approuvé Lámparas con aprobación europea

240-241

Technical Information

Information Technique Información técnica

242-263

Model Number Index

Index de Numéros de Pièces Índice por familia / número de parte

Grote Product Numbering System

Grote uses a meaningful product numbering system that makes it possible to quickly locate the correct product and verify the correct product has been selected. The typical Grote part number contains five digits, followed by a hyphen, followed by a single digit. Here's what it all means.

The first two digits or alpha characters (00000-0) indicate the product category.

G Hi Count™ LED Lamps

01-09 Per-Lux® Lamps and Accessories

10 Mirror Arms

11 Brackets

12 Small Mirrors

13 Junior West Coast Mirrors

16 Large West Coast Mirrors

18 Automotive Mirrors

20-24 Junior West Coast Bracketry and Assemblies

22 Large West Coast Mirrors

26 Large West Coast Mirror Assemblies

28 Mirror Specialties

40, 41 Reflectors and Conspicuity Tape

43 Guards Mounting Brackets and Permit Holders

44 Flashers

45-47, 49 Clearance / Marker and Identification Lamps

48 Turn Signal Switches

50-59 Multi-Function Stop / Tail / Turn Lamps, Rear Lamp

Modules, & Center High Mount Stop Lamps

60 License, Courtesy

62 Back Up Lamps

63 Flood Lamps

64 Tractor & Head Lamps, Quartz and Halogen

65 Boat Trailer Kits

66-69 Wire Harnesses and Pigtails

70, 71 Triangle Flares, Driving Cones, Warning

72 Automotive Horns

73 Back Up Alarms

76-77 Roto Beacon Strobes

78 Warning Lamps

82-83 Military

85 OE Type Replacement Lamps / Lenses

87 Ultra Link Power Cords

90-92 Lenses and Lamp Components

99 Miscellaneous

The second two digits or alpha characters (00000-0) indicate the product number.

The second two digits or alpha characters are unique to a specific product in any single category. When the first two digits [category] are combined with the second two digits [product] they form a base product number.

The fifth digit (00000-0) indicates product variations.

LAMPS

0 Split Color

1 Clear

2 Red

3 Yellow

4 Green

5 Blue

MIRROR PRODUCTS

1 White

2 Black

3 Chrome or Stainless

4 Aluminum

5 Zinc

The sixth digit (00000-0) indicates packaging.

1 Indicates Bulk Display Packaging

4 Indicates Pair Pack

5 Indicates Bubble Pack, Display Pack, Clam Shell or Retail Pack (Crystal-Pack or Slide Lock)

The absence of the sixth digit indicates product is in standard shelf packaging, e.g., individual pack or polybag, and in the case of lenses a standard shelf pack will have 6 to 12 to a container. Refer to your price sheet for exact quantity and other pack types.

new = New

fog = Compliant for J583 2004

● = Voltage other than 12 volts

Red numbers = Retail packaging

Reference Notes:

For each product listing we have included the latest applicable Federal Motor Vehicle Standards [FMVSS], SAE code and technical specifications. In this area we have also listed related accessory items such as Pigtails, Brackets and Grommets.

The part numbers listed are suggested items; they may not be the only alternative. However, additional part numbers that may better fit your application can be located in the Pigtails, Brackets and Grommets section.

* Some of the foregoing marks, including those identified with an asterisk, are names or marks of third-parties who are not affiliated with Grote Industries, Inc.

Model No.	Page	Model No.	Page	Model No.	Page	Model No.	Page	Model No.	Page
01-5444-71	56	83-6501	232	02001-4	124	10623	174	12243-5	170
01-5445-71	56	83-6502	233	02421-4	124	11133	175	12263-5	171
42-9003-H	123	83-6503	233	05001-5	124	11195	168	12272-5	167
42-9003-HWB	122	83-6505	232	05013-5	124	11293	175	12283	166
42-9003-TX	122	83-6508	231	05041-5	124	11303	175	12293	166
42-9004-H	123	83-6509	231	05051-5	124	12004	173	12301	169
42-9004-HWB	122	83-6510	230	05063-5	124	12004-5	173	12303	169
42-9004-LL	123	83-6511	230	05071-5	124	12010	167	12312-5	173
42-9004-TX	122	83-6512	230	05151	124	12014	173	12331	169
42-9005-13	123	83-6513	230	05171	124	12014-5	173	12333	169
42-9005-H	123	83-6515	231	05301-5	124	12020	167	12813	167
42-9005-HWB	122	83-6518	230	05401	124	12052	166	12983	166
42-9005-LL	123	83-6519	229	05511-5	125	12053	166	16021	163
42-9005-TX	122	83-6520	234	06001-4	125	12071	170	16023	163
42-9006-13	123	83-6527	231	06013-4	125	12072	170	16032	167
42-9006-H	123	83-6528	231	06021-4	125	12073	170	16033	167
42-9006-HWB	122	83-6530	234	06201	125	12073-5	170	16041	163
42-9006-LL	123	83-6535	232	07001-4	126	12101	170	16043	163
42-9006-TX	122	83-6536	235	07021-4	126	12102	170	16053	162
42-9007-H	123	83-6537	232	07031-4	126	12111-5	170	16063	162
42-9007-HWB	122	83-6538	234	07201	126	12112-5	170	16091	165
42-9007-LL	123	83-6539	233	07401	126	12113-5	170	16092	165
42-9007-TX	122	83-6540	234	07803	126	12122	173	16093	165
42-9008-13	123	83-6542	233	10002	174	12153	169	16101	164
61E61	91	83-6545	233	10012	174	12164	173	16102	164
61E81	96	83-6550	234	10013	174	12164-5	173	16123	163
61E91	96	83-6552	229	10025	174	12172	167	16142	164
61F01	96	83-6553	229	10045	174	12173	167	16153	164
61F11	96	84-9449	230	10073	175	12182	166	16172	162
80-1400	130	84-9450	231	10083	174	12183	166	16173	162
80-1401	130	01001-4	123	10173	175	12193-5	171	16202	163
83-6500	232	01051-4	123	10433	168	12201-5	173	16223	162

Model Number Index

Index de Numéros de Pièces Indice por familia / número de parte

<i>Model No.</i>	<i>Page</i>	<i>Model No.</i>	<i>Page</i>	<i>Model No.</i>	<i>Page</i>	<i>Model No.</i>	<i>Page</i>	<i>Model No.</i>	<i>Page</i>
16244	163	40232	215	43262-5	209	44720	151	45442	30
16273	164	40232-5	215	43272	209	44730	152	45443	30
16284	164	40233	215	43272-5	209	44740	146	45462	30
16294	164	40233-5	215	43282	205	44810	151	45463	30
16304	164	40302	213	43292	206	44810-5	151	45503	40
18103-5	172	40303	213	43300	106, 208	44820	151	45512	23
18252-5	172	40440-5	213	43325	207	44840-5	121	45512-5	23
18302-5	173	40460-5	213	43335	207	44850	151	45513	23
22002	169	40641	212	43343	201	44860	151	45513-5	23
22013	165	40641-5	212	43362	204	44870-5	121	45522	23
22061	165	40650	212	43370	195	44890	150	45523	23
22063	165	40650-5	212	43380	195	44891	150	45562	12
22193	168	40701	212	43390	197	44892	152	45563	12
22232	165	40980	212	43402	206	44893	152	45572	27
22233	165	41002	214	43411	211	44900	153	45573	27
26001-5	165	41003	214	43424	211	45002-5	19	45582	27
26012-5	165	41012	215	43430	193	45003-5	19	45583	27
26021-5	164	41013	215	43430-5	193	45012	33	45593	27
28031	166	41032	214	43468	191	45013	33	45603	27
28032	166	41032-5	214	43494	209	45021-5	103	45612	27
28033	166	41033	214	43512	194	45022	34	45613	27
28033-5	166	41033-5	214	43522	194	45022-5	34	45622	27
28041	166	41042	214	43532	194	45023	34	45623	27
28042	166	41043	214	43540	206	45023-5	34	45633	27
28043	166	41050	212	43550	208	45025-5	34	45642	27
28051	173	41080	212	43572	202	45032	34	45643	27
28063	168	41121	212	43642	202	45033	34	45662	29
28083-5	171	41122	212	43652	210	45042	15	45663	29
28091-5	171	41133	212	43655	202	45043	15	45672	22
28093-5	171	41142	213	43665	130	45052	15	45673	22
28152	166	41142-5	213	43673	199	45053	15	45712	29
28162	166	41143	213	43673-5	199	45062	12	45713	29
28193	168	41143-5	213	43684	177	45063	12	45762	28
28252-5	171	41152	213	43690	193	45072	15	45763	28
28293-5	171	41152-5	213	43702	201	45073	15	45772	28
28323-5	170	41153	213	43723	204	45082	18	45773	28
28393-5	171	41153-5	213	43732	202	45083	18	45783	28
28373-5	172	41160	212	43744	207	45092	19	45792	28
28423-5	172	41271	212	43760	193	45093	19	45793	28
28433-5	172	41273	212	43780	197	45102	22	45811	100
28443	168	42103	204	43783	197	45103	22	45812	15
28451	169	42110	196	43790	197	45132	22	45812-5	15
28453	169	42131	195	43823	192	45133	22	45813	15
28461	162	42141	195	43830	197	45142	19	45813-5	15
28463	162	42152	203	43842	209	45143	19	45821	82
28481	168	42153	203	43850	197	45162	18	45822	12
28491	169	42160	196	43883	196	45163	18	45822-5	12
28493	169	42162	196	43901	210	45172	33	45823	12
28663	166	42170	193	43910	208	45173	33	45823-5	12
28763	173	42172	193	43942	206	45182	15	45832	15
28812-5	172	42173	193	43952	204	45183	15	45833	15
28822-5	172	42180	194	43960	196	45202	12	45853	28
28832-5	172	42190	190	43962	196	45203	12	45932	25
28842-5	172	42192	190	43970	195	45222	15	45932-5	25
28852-5	172	42193	190	43980	195	45223	15	45933	25
28862-5	172	42222	240	44010	153	45232	20	45933-5	25
28872-5	172	43022	209	44030	153	45233	20	45993	40
28882-5	172	43022-5	209	44040	120	45242-5	19	46002	41
29060	165	43030	199	44060	120	45243-5	19	46003	41
40052	214	43040	191	44070	153	45252	22	46072	32
40052-5	214	43050	195	44090	150	45252-5	22	46073	32
40053	214	43074	198	44110	150	45253	22	46082	32
40053-5	214	43090	138	44134	146	45253-5	22	46083	32
40062	214	43100	205	44140	150	45262	25	46092	33
40063	214	43112	206	44151-5	121	45262-5	25	46132	11
40072	214	43120	199	44160	150	45263	25	46133	11
40072-5	214	43144	199	44170	146	45263-5	25	46142	13
40073	214	43150	191	44190	104	45273-5	79	46143	13
40073-5	214	43152	191	44240	103	45282	20	46152	18
40092	215	43153	191	44242	104	45283	20	46153	18
40093	215	43160	192	44360	104	45322	16	46161	240
40132	213	43162	192	44380	104	45323	16	46162	240
40132-5	213	43163	192	44421	146	45333	39	46163	240
40133	213	43172	204	44460	152	45382	22	46173	240
40133-5	213	43212	205	44530	151	45383	22	46180	240
40152	215	43220	204	44530-5	151	45412	17	46190	240
40153	215	43222	204	44540	151	45412-5	17	46200	240
40162	239	43223	204	44540-5	151	45413	17	46230	240
40163	239	43230	198	44690	151	45413-5	17	46240	240
40192	215	43240	138	44700	151	45432	25	46250	240
40193	215	43253	201	44710	151	45433	25	46260	240

Model Number Index

Index de Numéros de Pièces Indice por familia / número de parte

<i>Model No.</i>	<i>Page</i>	<i>Model No.</i>	<i>Page</i>	<i>Model No.</i>	<i>Page</i>	<i>Model No.</i>	<i>Page</i>	<i>Model No.</i>	<i>Page</i>
46282	33	46983-5	24, 75, 76	47963	20	50912	61	52672	46
46283	33	47012	19	47963-5	20	50920	58	52682	46
46292	33	47013	19	47972	20	50942	61	52692	46
46293	33	47032	31	47973	20	50952	61	52712-5	78
46302	30	47033	31	47982	20	50972	62	52722-5	78
46303	30	47051	24	47983	20	50972-5	62	52742-5	75
46312	30	47052	24	47992	30	50992	61	52770	45
46313	30	47053	24	47993	30	51002	47	52772	45
46322	41	47063	39	48062	159	51012	47	52772-5	45
46323	41	47072	31	48072	156	51022	47	52773	45
46332	41	47073	31	48132	159	51032	47	52782	45
46333	41	47082	17	48272	157	51042	72	52783	45
46342	32	47083	17	48282	157	51052	47	52822	62
46343	32	47084	17	48283	159	51090	202	52832	62
46392	23	47085	17	48284	160	51142	72	52892	52
46392-5	23	47092	18	48302	161	51242	72	52892-5	52
46393	23	47093	18	48402	156	51242-5	72	52893	52
46393-5	23, 76	47102	13	48432	160	51342-5	72	52893-5	52
46412	18	47103	13	48433	160	51932	77	52902	60
46412-5	18	47112	11	48442	160	51942	77	52912	60
46413	18	47112-5	11	48512	161	51982	75	52922	46
46413-5	18	47113	11	48522	158	51982-5	75	52922-5	46
46422-5	18	47113-5	11	48532	158	51992	75	52923	46
46423-5	18	47122	13	48542	158	51992-5	75	52952	44
46433	38	47122-5	13	48552	158	52002	73	52972	63
46442-5	79	47123	13	48562	156	52010	134	53000	67
46443-5	79	47123-5	13	48563	156	52023	55	53012	46
46492-5	32	47162	31	48602	161	52062	55	53012-5	46
46493-5	32	47163	31	49002	35	52063	55	53013-5	46
46543	40	47183	38	49042	35	52072	49	53020	67
46543-5	40	47202	13	49062	37	52073	49	53023	67
46702	24	47212	12	49072	38	52082	72	53032	67
46702-5	24	47213	12	49073	38	52092	42	53052	67
46703	24	47222	16	49082	38	52093	42	53053	68
46703-5	24	47223	16	49112	37	52112	73	53062	55
46712	24	47232	14	49112-5	37	52122	73	53063	55
46712-5	24	47233	14	49122	36	52152	45	53082-5	74
46713	24	47242	21	49132	36	52153	45	53092	52
46713-5	24	47243	21	49140	194	52162	43	53092-5	52
46740	19	47252	29	49142	35	52163	43	53093	52
46742	19	47253	29	49162	34	52182	52	53100	45
46742-5	19	47262	29	49172	35	52182-5	52	53102	45
46743	19	47263	29	49173	35	52183	52	53103	45
46743-5	19	47322	13	49182	35	52183-5	52	53112	45
46772	25	47323	13	49192	36	52193	54	53122	49
46773	25	47332	11	49202	36	52202	57	53123	49
46782	26	47333	11	49203	36	52203	57	53132	57
46783	26	47352	31	49212-5	37	52253	54	53133	57
46791	100	47353	31	49223	36	52302	76	53163	55
46792	26	47362	21	49232-5	37	52302-5	76	53182	43
46792-5	26	47363	21	49242-5	37, 75, 78	52312	76	53192	43
46793	26	47372	14	49252	21	52312-5	76	53193	43
46793-5	26	47373	14	49253	21	52323	53	53252	42
46802	32	47423	14	49292	36	52353	53	53253	42
46803	32	47462	21	50132	70	52362	80	53272	42
46813	38	47463	21	50222	48	52372	80	53273	42
46823	38	47472	13	50232	49	52383	53	53282	42
46832	31	47473	13	50232-5	49	52393	53	53292	42
46832-5	31	47492	18	50352	69	52423	53	53293	42
46833	31	47493	18	50502	48	52442	77	53302	42
46833-5	31	47502	20	50532	76	52452	77	53303	42
46862	32	47503	20	50532-5	76	52462	77	53312	43
46863	32	47732	30	50542	76	52462-5	77	53313	43
46872	31	47733	30	50542-5	76	52472	77	53322	43
46872-5	31	47772	27	50630	68	52472-5	77	53342	42
46873	31	47773	27	50630-5	68	52482	78	53413	43
46873-5	31	47852-5	75	50642	68	52492	78	53422	69
46882	23	47853-5	75	50642-5	68	52512	54	53432	42
46882-5	23	47863	79	50652	68	52513	54	53442	42
46883	23	47872-5	18	50662	68	52522	48	53452	42
46883-5	23	47873-5	18	50762	79	52533	54	53462	42
46892	34	47912	29	50820	47	52543	54	53493	53
46892-5	34	47913	29	50852	64	52553	54	53523	43
46893	34	47922	29	50852-5	64	52562	51	53532	42
46893-5	34	47923	29	50862	64	52563	51	53542	43
46902	22	47952	20	50862-5	64	52572	52	53552	42
46903	22	47952-5	20	50872	64	52573	52	53553	42
46913	39	47953	20	50872-5	64	52582	51	53582	56
46922	22	47953-5	20	50882	64	52602	63	53582-5	56
46933	22	47962	20	50892	64	52612	48	53592	49
46982-5	24, 75, 76	47962-5	20	50902	61	52652-5	75	53593	49

Model Number Index

Index de Numéros de Pièces Índice por familia / número de parte

<i>Model No.</i>	<i>Page</i>	<i>Model No.</i>	<i>Page</i>	<i>Model No.</i>	<i>Page</i>	<i>Model No.</i>	<i>Page</i>	<i>Model No.</i>	<i>Page</i>
53612	46	55573	46	61451	93	63221-5	110	64551-5	111
53622	49	55712	45	61461	93	63231-5	110	64561	107
53623	49	55713	45	61491-5	98	63241-5	109	64571	118
53630	58	55772	52	61501	102	63251-5	109	64581-5	119
53640	58	55773	52	61501-5	102	63271	110	64611	108
53650	58	55783	51	61511	91	63291-5	109	64621	108
53662	75	55982	69	61571	94	63301-5	109	64631-5	119
53672	75	55983	69	61611	91	63321-5	108	64890	110
53702	59	55992	69	61621	91	63381	113, 114	64891	110
53712	59	55993	69	61641	98	63391	113, 114	64901	109
53722	60	56000	67	61760	97	63401-4	114	64911	111
53762	60	56020	67	61771	95	63441-4	114	64921	106
53782	59	56032	67	61793	96	63451-4	113	64930	106
53792	59	56033	67	61811	95	63455-4	114	64931	106
53812	78	56052	67	61821	94	63531	120	64931-5	106
53822	78	56053	68	61831	94	63551	106	64940	107
53833	55	56072	70	61861	97	63561	106	64941	107
53843	55	56073	70	61871	97	63571	105	64943	107
53853	55	56083	70	61881	91	63581	105	64971	106
53883	69	60001	83	61890	97	63591	105	64981-5	106
53962	49	60011	83	61901	92	63601	105	64991	106
53963	49	60011-5	83	61921	97	63610	106	65092-5	23, 73
53972	49	60021	82	61931	97	63611	105	65093-5	23, 73
53973	49	60081	83	61961	97	63621	105	65130	141
54002	56	60101	102	61971	93, 106	63641	105	65132	141
54012	55	60101-5	102	61981	96	63651	105	65152	18
54022	42	60121	83	61991	97	63661	105	65153	18
54023	42	60131	83	62011	89	63671	105	65190-5	76
54032	42	60151	102	62021	89	63681	105	65202	18
54033	42	60151-5	102	62021-5	89	63691	105	65203	18
54042	42	60191	82	62051	87	63731	105	65230-5	75
54102	42	60251	101	62061	87	63741	105	65240-5	77
54132	50	60251-5	101	62091	85	63751	105	65282	11
54133	50	60261	82	62101	85	63761	105	65300-5	78
54142	50	60271	99	62111	87	63771	105	65312	78
54143	50	60280	82	62121	86	63921	112	65320-5	75
54162	50	60291	83	62131	86	63941	112	65330-5	75
54163	50	60301	99	62151	89	64003-5	117	65350-5	76
54172	51	60311	90	62171	86	64011	108	65370-5	76
54173	51	60321	81	62181	86	64021	108	65380-5	76
54332	43	60331	82	62201	89	64031	108	65390-5	50, 74
54333	43	60341	81	62211	84	64061-5	117	65402-4	71
54342	44	60351	101	62221	84	64071	111	65410-5	74
54343	44	60361	101	62231	88	64101	106	65432-4	71
54362	43	60381	81	62241	88	64111	111	65440-5	77
54363	43	60411	99	62251	88	64120	111	65512	21
54402	241	60421	99	62261	88	64123	111	65513	21
54412	241	60460	82	62271	84	64131	112	65560-5	75
54422	241	60481	103	62291	90	64151	113	65570-5	78
54432	241	60551-5	113	62321	86	64161-5	117	65590	192
54462	43	60561	100	62331	84	64163-5	117	65592	192
54463	43	60571	100	62381	89	64181-5	117	65650	190
54472	43	60581	96	62391	85	64213-5	118	65720-5	71
54473	43	60591	96	62401	84	64221	110	65730-5	71
54482	43	60601	81	62421	86	64231	110	65782	81
54483	43	61021	93	62431	85	64241	113	65790	81
54492	43	61031	97	62451	85	64251	113	65820	241
54493	43	61051	94	62511	84	64261-4	113	65830	241
55092	49	61061	95	62521	89	64271	113	66002	179
55103	43	61071	91	62541	84	64281	113	66003	179
55153	43	61081	98	62561	87	64291-4	113	66004	179
55220	68	61091	94	62571	85	64301-5	118	66071	178
55220-5	68	61091-5	94	62591	87	64311-5	118	66081	178
55223	68	61111	91	62601	87	64340	108	66100	180, 183
55223-5	68	61121	92	62671	84	64341	108	66101	180
55232	68	61131	92	62691	85	64351-5	119	66104	182
55242	68	61141	93	62720	86	64371-5	117	66105	182
55243	68	61161	94	62751	88	64381-5	117	66110	180
55280	67	61171	92	62761	87	64391	108	66111	188
55290	67	61191	95	63051	90	64401-5	119	66113	181
55340	65	61221	98	63061	95	64411	107	66121	182
55410	66	61261	91	63111-5	108	64431-5	119	66122	181
55420	66	61281	96	63121-5	108	64440	107	66123	181
55430	66	61301	97	63131-5	108	64441	107	66124	181
55440	66	61361	93	63151-5	109	64451-5	119	66125	181
55450	66	61371	91	63161-5	109	64461	107	66133	182
55460	66	61391	92	63171-5	109	64471	107	66135	183
55470	65	61401	92	63181-5	109	64481-5	120	66141	183
55510	66	61411	92	63191-5	109	64491	107	66143	183
55520	66	61421	92	63201-5	109	64501-5	120	66145	183
55572	46	61431	94	63211-5	110	64541-5	111	66150	183

Model Number Index

Index de Numéros de Pièces Indice por familia / número de parte

<i>Model No.</i>	<i>Page</i>	<i>Model No.</i>	<i>Page</i>	<i>Model No.</i>	<i>Page</i>	<i>Model No.</i>	<i>Page</i>	<i>Model No.</i>	<i>Page</i>
66151.....	183	67011.....	188	76035.....	144	77583.....	130	78473.....	140
66152.....	183	67013.....	186	76043.....	143	77593.....	133	78563.....	115
66153.....	183	67014.....	188	76053.....	143	77603.....	130	78573.....	115
66154.....	183	67016.....	187	76063.....	143	77611.....	131	78593.....	17
66155.....	183	67020.....	188	76082.....	140	77612.....	131	78980.....	140
66160.....	181, 183	67050.....	184	76083.....	140	77613.....	131	82005.....	236
66161.....	181	67050-5.....	184	76085.....	140	77615.....	131	82013.....	236
66162.....	181	67060.....	145	76121.....	207	77622.....	131	82022.....	237
66163.....	181	67061.....	145	76162.....	143	77623.....	131	82033.....	236
66164.....	182	67070.....	185	76163.....	143	77625.....	131	82042.....	237
66165.....	183	67071.....	185	76183.....	143	77632.....	131	82062.....	237
66170.....	180, 183	67090.....	187	76185.....	143	77633.....	131	82063.....	237
66171.....	183	67090-5.....	187	76203.....	141	77635.....	131	82071.....	239
66180.....	183	67120.....	183, 184	76222.....	141	77641.....	132	82080.....	239
66190.....	181	67150.....	199	76223.....	141	77642.....	132	82081.....	239
66200.....	181	67151.....	203	76225.....	141	77643.....	132	82085.....	239
66210.....	181	67250.....	179	76243.....	142	77645.....	132	82091.....	239
66220.....	182	67260.....	179	76283.....	141	77652.....	132	82092.....	239
66221.....	182	67270.....	179	76285.....	141	77653.....	132	82102.....	238
66222.....	182	67271.....	179	76333.....	141	77655.....	132	82103.....	238
66223.....	182	67301.....	179	76443.....	143	77662.....	132	82112.....	238
66224.....	182	67302.....	179	76462.....	142	77663.....	132	82113.....	238
66225.....	180	67303.....	179	76463.....	142	77665.....	132	82122.....	238
66311.....	178	67304.....	179	76465.....	142	77671.....	132	82123.....	238
66360.....	185	67305.....	179	76473.....	138	77672.....	132	82135.....	236
66510.....	183	67315.....	181	76483.....	142	77673.....	132	82145.....	236
66701.....	178	67400.....	179	76493.....	142	77675.....	132	82153.....	236
66702.....	178	67401.....	179	76552.....	135	77682.....	132	82163.....	236
66705.....	178	67402.....	179	76553.....	135	77683.....	132	82172.....	237
66711.....	178	67403.....	179	76554.....	135	77685.....	132	82182.....	237
66800.....	184	67404.....	179	76602.....	137	77691.....	131	82193.....	236
66801.....	184	67405.....	179	76603.....	137	77692.....	131	82203.....	236
66810.....	189	67413.....	181	76612.....	137	77693.....	131	82212.....	237
66811.....	187	67521.....	179	76613.....	137	77695.....	131	82222.....	237
66812.....	187	67524.....	179	76802.....	138	77703.....	139	82232.....	238
66813.....	189	68080.....	190	76803.....	138	77711.....	132	82233.....	238
66814.....	189	68100.....	190	76805.....	138	77712.....	132	82303.....	236
66815.....	186	68110.....	190	76813.....	138	77713.....	132	82313.....	236
66816.....	186	68130.....	190	76903.....	139	77715.....	132	82322.....	237
66820.....	189	68150.....	190	76923.....	139	77723.....	139	82332.....	237
66823.....	189	68170.....	190	76933.....	139	77732.....	132	82340-5.....	237
66825.....	187	68380.....	190	76935.....	139	77733.....	132	82350-5.....	237
66826.....	188	68420.....	80	76963.....	130	77735.....	132	82370.....	239
66830.....	189	68460-5.....	121	76983.....	136	77743.....	133	82380.....	239
66831.....	189	68470.....	115	76993.....	136	77753.....	137	82390.....	239
66836.....	189	68471.....	115	77003.....	137	77763.....	135	82400.....	239
66840.....	184	68472.....	115	77012.....	144	77773.....	135	82442.....	238
66841.....	186	68473.....	116	77013.....	144	77811.....	127	82443.....	238
66842.....	186	68474.....	116	77015.....	144	77813.....	127	82485.....	236
66843.....	187	68475.....	116	77101.....	144	77823.....	127	82521.....	238
66843-5.....	187	68520.....	80	77102.....	144	77833.....	127	82552.....	215, 239
66844.....	187	68540-5.....	80	77103.....	144	77843.....	127	82553.....	215, 239
66845.....	186	68680.....	188	77105.....	144	77853.....	127	82562.....	215, 239
66846.....	187	69680.....	157	77121.....	131	77863.....	127	82563.....	215, 239
66850.....	184	69681.....	157	77123.....	131	77873.....	128	82593.....	236
66851.....	184	69690.....	157	77133.....	133	77893.....	128	82602.....	237
66860.....	189	71152.....	216	77153.....	138	77912.....	134	82635.....	236
66861.....	188	71422.....	216	77163.....	138	77913.....	134	82640-5.....	237
66862.....	188	71440.....	216	77165.....	138	77923.....	134	82762.....	238
66870.....	186	71450.....	216	77173.....	138	77931.....	136	82763.....	238
66900.....	185	72010-5.....	149	77192.....	129	77932.....	136	85002-5.....	221
66902.....	186	72050-5.....	149	77193.....	129	77933.....	136	85003-5.....	221
66903.....	185	72100-5.....	149	77203.....	144	77935.....	136	85013-5.....	221
66904.....	185	72110-5.....	149	77263.....	134	78002.....	70	85023-5.....	221
66905.....	185	73030.....	147	77351.....	128	78003.....	70	85033-5.....	221
66910.....	185	73040.....	148	77352.....	128	78150.....	70	85043-5.....	221
66911.....	185	73040-5.....	148	77353.....	128	78152.....	70	85052.....	221
66920.....	185	73080.....	147	77355.....	128	78153.....	70	85053-5.....	221
66930.....	184	73090.....	148	77361.....	129	78260.....	140	85062.....	221
66931.....	184	73110.....	148	77362.....	129	78303.....	70	85063-5.....	221
66932.....	188	73120.....	149	77363.....	129	78313.....	70	85072-5.....	221
66980.....	184	73120-5.....	149	77365.....	129	78322.....	70	85082-5.....	221
66981.....	184	73140-5.....	149	77373.....	138	78333.....	12	85093-5.....	221
66982.....	184	73150-5.....	149	77443.....	133	78343.....	15	85103-5.....	221
67000.....	187	73160.....	147	77453.....	129	78360.....	140	85112-5.....	221
67001.....	184	73220.....	148	77461.....	135	78363.....	31	85122-5.....	221
67001-5.....	184	73240.....	148	77462.....	135	78393.....	19	85132-5.....	221
67002.....	186	73250.....	148	77463.....	135	78403.....	31	85142-5.....	221
67005.....	186	76032.....	144	77473.....	133	78423.....	13	85152-5.....	221
67006.....	189	76033.....	144	77483.....	133	78433.....	11	85162-5.....	221
67010.....	188	76034.....	144	77503.....	130	78453.....	21	85172-5.....	221

Model Number Index

Index de Numéros de Pièces Índice por familia / número de parte

<i>Model No.</i>	<i>Page</i>	<i>Model No.</i>	<i>Page</i>	<i>Model No.</i>	<i>Page</i>	<i>Model No.</i>	<i>Page</i>	<i>Model No.</i>	<i>Page</i>
85182-5	221	85973	223	87100	176	90630	122	92513	201
85192-5	221	85982	223	87101	176	90642	226	92513-5	201
85202-5	221	85983	223	87110	176	90652	78, 226	92583	198
85212-5	221	85993	223	87111	176	90742	226	92611	227
85222-5	221	86002	223	87140	176	90743	226	92691	227
85232-5	221	86003	223	87150	176	90752	226	92692	227
85242-5	221	86013	223	87220	177	90761	226	92693	227
85252-5	221	86023	223	87240	177	90762	226	92701-5	122
85262-5	221	86032	223	87250	177	90861-5	122	92720	203
85273-5	222	86033	223	87270	177	90901	122	92761	227
85283-5	222	86043	223	87590	177	90922	226	92762	227
85292-5	222	86053	223	87781	146	90923	226	92763	227
85302-5	222	86063	223	87790	147	90971-5	122	92773	227
85313-5	222	86073	223	87830	177	91042	226	92792	227
85323-5	222	86083	223	87860	177	91043	226	92820	145
85332-5	222	86093	223	87890	235	91051	122	92833	227
85342-5	222	86103	223	87891	235	91060	195	92841	227
85352-5	222	86113	223	90011	226	91101	226	92883	227
85362-5	222	86121	223	90012	226	91112	226	92885	227
85372-5	222	86131	223	90012-5	226	91113	226	92892	227
85382-5	222	86141	223	90013	226	91122	227	92893	227
85392-5	222	86151	223	90022	226	91152	227	92901	227
85402-5	222	86161	223	90051	226	91153	227	92920	192
85412-5	222	86171	223	90052	226	91172	227	92943	228
85422-5	222	86180	223	90053	226	91173	227	92960	145
85432-5	222	86190	223	90062	226	91302	227	92970	145
85442-5	222	86202	223	90063	226	91311	227	92980	145
85450-5	222	86212	223	90072	226	91323	226	92993	228
85460-5	222	86221	223	90073	226	91380	194	92995	228
85472-5	222	86231	223	90092	226	91400	191	93001	228
85482-5	222	86242	223	90093	226	91410	192	93002	228
85493-5	222	86252	223	90103	226	91482	227	93003	228
85503-5	222	86262	223	90121	226	91502	227	93005	228
85512-5	222	86272	223	90122	226	91503	227	93043	228
85522-5	222	86282	223	90122-5	226	91513	227	93053	228
85532-5	222	86292	223	90123	226	91572	227	93013	227
85542-5	222	86302	224	90123-5	226	91573	227	93015	227
85552-5	222	86312	224	90133	226	91581	227	93131	228
85562-5	222	86322	224	90142	226	91582	227	93151	228
85572-5	222	86332	224	90143	226	91583	227	93163	228
85582-5	222	86342	224	90152	226	91683	227	93171	228
85592-5	222	86352	224	90152-5	226	91740	199	93190	201
85602-5	222	86360	224	90153	226	91740-5	199	93212	209
85612-5	222	86370	224	90153-5	226	91880	192	93252	228
85622-5	222	86380	224	90162	226	91890	192	93283	228
85632-5	222	86390	224	90163	226	91950	200	93383	228
85642-5	222	86400	224	90172	75, 226	91961	227	93393	228
85652-5	222	86412	224	90173	226	91962	227	93400	194
85662-5	222	86422	224	90202	226	91962-5	227	93402	194
85672-5	222	86432	224	90202-5	226	91963	227	93453	197
85682-5	222	86442	224	90203	226	91963-5	227	93473	197
85692-5	222	86452	224	90203-5	226	91964	227	93483	198
85702-5	222	86462	224	90221	226	91965	227	93491	228
85712-5	222	86472	224	90232	226	91992	227	93531	228
85722-5	222	86482	224	90233	226	91993	227	93532	228
85732-5	222	86492	224	90235	226	92031	227	93533	228
85742-5	222	86502	224	90252	226	92032	227	93550	200
85752-5	222	86512	224	90301	226	92033	227	93552	200
85762-5	222	86522	224	90302	226	92035	227	93553	200
85772-5	222	86532	224	90302-5	226	92062	227	93600	208
85782-5	222	86542	224	90303	226	92063	227	93601	208
85792-5	222	86573	224	90305	226	92070	191	93602	208
85802-5	222	86583	224	90342	226	92120	190	93603	208
85812-5	222	86593	224	90342-5	226	92150	190	93610	83
85822-5	222	86603	224	90352	226	92162	227	93651	228
85832-5	222	86613	224	90353	226	92163	227	93652	228
85842-5	222	86622	224	90355	226	92172	227	93653	228
85852-5	222	86632	224	90363	226	92173	227	93670	192
85862-5	223	86642	224	90371	226	92183	227	93683	200
85872-5	223	86652	224	90372	226	92193	227	93701	228
85882	223	86680	224	90373	226	92313	227	93713	198
85892	223	86703	224	90375	226	92382	227	93723	228
85902	223	86713	224	90383	226	92402	227	93750	193
85912	223	86740	224	90385	226	92420	203	93760	191
85922	223	86752	224	90393	226	92420-5	203	93773	206
85932	223	86762	224	90401	226	92432	227	93790	103
85941	223	86772	224	90481	226	92433	227	93803	196
85943	223	86781	224	90482	226	92453	227	93850	200
85952	223	86783	224	90483	226	92510	201	93860	190, 193
85962	223	87020	176	90512	226	92511	201	93891	228
85972	223	87023	176	90620	122	92512	201	93923	228

Model Number Index

Index de Numéros de Pièces Indice por familia / número de parte

<i>Model No.</i>	<i>Page</i>	<i>Model No.</i>	<i>Page</i>	<i>Model No.</i>	<i>Page</i>	<i>Model No.</i>	<i>Page</i>	<i>Model No.</i>	<i>Page</i>
93960.....	203	99510.....	177, 178	G1053-5.....	15	G4002-5.....	44	G6002.....	50
93982.....	205	99580.....	211	G1082.....	16	G4003.....	44	G6002-5.....	50
94000.....	192	99593.....	203	G1082-5.....	16	G4003-5.....	44	G6003.....	50
94010.....	191	99595.....	203	G1083.....	16	G4012.....	44	G6003-5.....	50
94082.....	228	99630.....	141	G1083-5.....	16	G4012-5.....	44	G6012.....	50
94083.....	228	99680.....	235	G1092.....	15	G4022.....	44	G6013.....	50
94092.....	228	99802.....	228	G1093.....	15	G4023.....	44	G6151.....	102
94093.....	228	99803.....	228	G1502.....	17	G4502.....	57	G6261.....	101
94100.....	190	99832.....	228	G1502-5.....	17	G4502-5.....	57		
94110.....	202	99833.....	228	G1503.....	17	G4503.....	57		
94180.....	205	99842.....	228	G1503-5.....	17	G4503-5.....	57		
94210.....	77	99843.....	228	G1512-5.....	17	G4602.....	26		
94220.....	196	99850.....	145	G1513-5.....	17	G4602-5.....	26		
94233.....	195	99863.....	228	G1902.....	19	G4603.....	26		
94540.....	201	99871.....	228	G1902-5.....	19	G4603-5.....	26		
94690.....	210	99872.....	228	G1903.....	19	G4612.....	26		
97750.....	208	99880.....	145	G1903-5.....	19	G4613.....	26		
97810.....	176	99912.....	228	G1912.....	19	G5052.....	40		
97900.....	235	99913.....	228	G1913.....	19	G5052-5.....	40		
97910.....	235	G1002.....	14	G2102.....	31	G5053.....	40		
97942.....	136	G1002-5.....	14	G2102-5.....	31	G5053-5.....	40		
97943.....	136	G1003.....	14	G2103.....	31	G5082-5.....	59		
98001-5.....	229	G1003-5.....	14	G2103-5.....	31	G5092-5.....	59		
99170.....	211	G1032.....	14	G3002.....	11	G5202.....	59		
99170-1.....	211	G1032-5.....	14	G3002-5.....	11	G5212.....	59		
99180.....	211	G1033.....	14	G3003.....	11	G5300.....	67		
99250.....	145	G1033-5.....	14	G3003-5.....	11	G5300-5.....	67		
99460-5.....	80	G1042.....	14	G3092.....	12	G5530.....	65		
99490.....	208	G1043.....	14	G3092-5.....	12	G5530-5.....	65		
99500-3.....	180	G1052.....	15	G3093.....	12	G5540.....	65		
99501-3.....	180	G1052-5.....	15	G3093-5.....	12	G5540-5.....	65		
99502.....	180	G1053.....	15	G4002.....	44	G5543-5.....	65		

Multi-Volt and Non 12-Volt Product Index

<i>Model No.</i>	<i>Page</i>	<i>Model No.</i>	<i>Page</i>	<i>Model No.</i>	<i>Page</i>	<i>Model No.</i>	<i>Page</i>	<i>Model No.</i>	<i>Page</i>
61E91.....	24V... 96	47353.....	24V... 31	63671.....	24V... 105	77453.....	12-24V.. 129	77723.....	12-48V.. 139
61F11.....	24V... 96	47362.....	24V... 21	63681.....	24V... 105	77503.....	12-48V.. 130	77732.....	12-24V.. 132
44010.....	12-24V.. 153	47363.....	24V... 21	63691.....	24V... 105	77583.....	12-48V.. 130	77733.....	12-24V.. 132
44030.....	12-24V.. 153	52010.....	12-24V.. 134	63731.....	24V... 105	77593.....	2-48V.. 133	77735.....	12-24V.. 132
44070.....	12-24V.. 153	52072.....	24V... 49	63741.....	24V... 105	77603.....	12-48V.. 130	77743.....	12-24V.. 133
44134.....	12-36V.. 146	52073.....	24V... 49	63751.....	24V... 105	77611.....	12-24V.. 131	77753.....	12-24V.. 137
44421.....	12-80V.. 146	52092.....	24V... 42	63761.....	10-30V.. 105	77612.....	12-24V.. 131	77873.....	12-24V.. 128
44850.....	24V... 151	52093.....	24V... 42	63771.....	24V... 105	77613.....	12-24V.. 131	77893.....	12-24V.. 128
44860.....	24V... 151	52152.....	24V... 45	64391.....	24V... 108	77615.....	12-24V.. 131	78671.....	12-24V.. 136
44870-5.....	6-24V.. 121	52153.....	24V... 45	64461.....	24V... 107	77622.....	12-24V.. 131	78672.....	12-24V.. 136
45142.....	24V... 19	52162.....	24V... 43	64491.....	24V... 107	77623.....	12-24V.. 131	78673.....	12-24V.. 136
45143.....	24V... 19	52163.....	24V... 43	64921.....	24V... 106	77625.....	12-24V.. 131	78674.....	12-24V.. 136
45162.....	24V... 18	52162.....	24V... 43	64981-5.....	6V... 106	77632.....	12-24V.. 131	78675.....	12-24V.. 136
45163.....	24V... 18	52163.....	24V... 43	65830.....	24V... 241	77633.....	12-24V.. 131	77931.....	10-16V.. 136
45182.....	24V... 15	54402.....	24V... 241	73030.....	12-36V.. 147	77635.....	12-24V.. 131	77932.....	10-16V.. 136
45183.....	24V... 15	54412.....	24V... 241	73040.....	12-24V.. 148	77641.....	12-24V.. 132	77933.....	10-16V.. 136
45202.....	24V... 12	54422.....	24V... 241	73040-5.....	12-24V.. 148	77642.....	12-24V.. 132	77935.....	10-16V.. 136
45203.....	24V... 12	54432.....	24V... 241	73080.....	12-24V.. 147	77643.....	12-24V.. 132	82005.....	10-34V.. 236
45222.....	24V... 15	55153.....	24V... 43	73090.....	12-24V.. 148	77645.....	12-24V.. 132	82013.....	10-34V.. 236
45223.....	24V... 15	61021.....	24V... 93	73110.....	12-24V.. 148	77652.....	12-24V.. 132	82022.....	10-34V.. 237
46152.....	24V... 18	61061.....	24V... 95	73160.....	12-36V.. 147	77653.....	12-24V.. 132	82033.....	10-34V.. 236
46153.....	24V... 18	61071.....	24V... 91	73220.....	12-24V.. 148	77655.....	12-24V.. 132	82042.....	10-34V.. 237
46161.....	9-33V.. 240	61111.....	24V... 91	73240.....	12-36V.. 148	77662.....	12-24V.. 132	82062.....	24V... 237
46162.....	9-33V.. 240	61131.....	24V... 92	73250.....	12-36V.. 148	77663.....	12-24V.. 132	82063.....	24V... 237
46163.....	9-33V.. 240	61391.....	24V... 92	76063.....	24V... 143	77665.....	12-24V.. 132	82071.....	9-30V.. 239
46173.....	9-33V.. 240	61401.....	24V... 92	76283.....	24V... 141	77671.....	12-24V.. 132	82080.....	10-32V.. 239
46180.....	9-33V.. 240	61421.....	24V... 92	76285.....	24V... 141	77672.....	12-24V.. 132	82081.....	9-30V.. 239
46190.....	9-33V.. 240	61760.....	9-30V.. 97	76473.....	24V... 138	77673.....	12-24V.. 132	82085.....	9-30V.. 239
46200.....	9-33V.. 240	61861.....	10-30V.. 97	76963.....	12-48V.. 130	77675.....	12-24V.. 132	82091.....	10-30V.. 239
46230.....	12-24V.. 240	61871.....	10-30V.. 97	77012.....	12-80V.. 144	77682.....	12-24V.. 132	82092.....	10-30V.. 239
46240.....	12-24V.. 240	61890.....	9-30V.. 97	77013.....	12-80V.. 144	77683.....	12-24V.. 132	82102.....	24V... 238
46250.....	12-24V.. 240	61961.....	10-16V.. 97	77015.....	12-80V.. 144	77685.....	12-24V.. 132	82103.....	24V... 238
46260.....	12-24V.. 240	61991.....	10-16V.. 97	77101.....	12-80V.. 144	77691.....	12-24V.. 131	82112.....	24V... 238
46342.....	24V... 32	62321.....	24V... 86	77102.....	12-80V.. 144	77692.....	12-24V.. 131	82113.....	24V... 238
46343.....	24V... 32	62541.....	24V... 84	77103.....	12-80V.. 144	77693.....	12-24V.. 131	82122.....	10-34V.. 238
47073.....	24V... 31	62571.....	24V... 85	77105.....	12-80V.. 144	77695.....	12-24V.. 131	82123.....	10-34V.. 238
47322.....	24V... 13	63241-5.....	24V... 109	77121.....	12-48V.. 131	77703.....	12-48V.. 139	82135.....	10-34V.. 236
47323.....	24V... 13	63251-5.....	24V... 109	77123.....	12-48V.. 131	77711.....	12-24V.. 132	82145.....	10-34V.. 236
47332.....	24V... 11	63571.....	10-30V.. 105	77133.....	12-48V.. 133	77712.....	12-24V.. 132	82153.....	10-34V.. 236
47333.....	24V... 11	63581.....	10-30V.. 105	77203.....	12-80V.. 144	77713.....	12-24V.. 132	82163.....	10-34V.. 236
47352.....	24V... 31	63591.....	10-30V.. 105	77263.....	12-24V.. 134	77715.....	12-24V.. 132	82172.....	10-34V.. 237

Clearance / Marker Lamps

Feux de Gabarit / Position Lámparas de Gálibo / Demarcadora

SUPERNOVA® 2" CLEARANCE / MARKER LED LAMP

Encapsulant potting for total circuit-board protection • Hermetic lens-to-housing seal • Uses same UBS double-seal pigtail as incandescent for quick Plug-and-Go® retrofit • Tin-plated, solid-brass terminals are sealed to housing, to resist corrosion and eliminate failure-causing leak paths

- 47112** Red
- 47112-5** Red, Retail Pack
- 47113** Yellow
- 47113-5** Yellow, Retail Pack
- 47332** Red, 24-Volt
- 47333** Yellow, 24-Volt

KITS:
65282 Red (47112 + 94100 + 67050)

ABS LAMP:
78433 Yellow

Material: Polycarbonate
FMVSS: P2
Finish: Red / Yellow
Volts / Amps: 12V - .06A
Volts / Amps: Red - 24V / .03A
Volts / Amps: Yellow - 24V / .04A
Bracket: 43690, 49140, 43150, 43152, 43153, 43532, 43760, 42180, 42190, 42192, 42193
Grommet: 92120, 92150
Pigtail: 66851, 66850, 67001, 67050, 66800, 66840, 66801

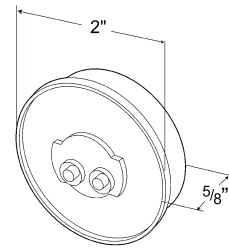

SUPERNOVA® 2" PC-RATED, CLEARANCE / MARKER LED LAMP

Hermetic lens-to-housing seal • Uses the same UBS double-seal pigtail as the incandescent version for a quick Plug-and-Go® retrofit • Fits all popular mountings and grommets • Fully sealed electronics using encapsulant potting • Meets PC function when mounted at a 45° angle

- 46132** Red **new**
- 46133** Yellow **new**

Material: Polycarbonate
FMVSS: P2, P3, PC
Finish: Red / Yellow
Volts / Amps: 12V / .06A
Bracket: 43690, 49140, 43150, 43152, 43153, 43532, 43760, 42180, 42190, 42192, 42193
Grommet: 92120, 92150
Pigtail: 67050, 67001, 66851, 66850, 66800, 66840, 66801

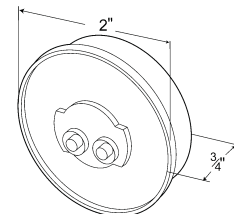

HI COUNT® 2" LED LAMP

Hermetic lens-to-housing seal • Uses the same UBS double-seal pigtail as the incandescent version for a quick Plug-and-Go® retrofit • Twist-on mounting for easy installation • Concentric, multiple-diode layout • Fits all popular mountings and grommets

- G3002** Red
- G3002-5** Red, Retail Pack **new**
- G3003** Yellow
- G3003-5** Yellow, Retail Pack **new**

Material: Polycarbonate
FMVSS: P2
Finish: Red / Yellow
Volts / Amps: 12V / .09A
Bracket: 43690, 43150, 43152, 43153, 43532, 49140, 43760, 42180, 42190, 42192, 42193
Grommet: 92120, 92150
Pigtail: 67050, 67001, 66851, 66850, 66800, 66840, 66801

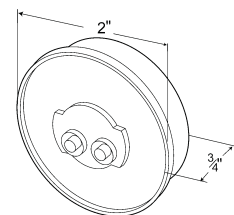

Clearance / Marker Lamps

Feux de Gabarit / Position Lámparas de Gálíbo / Demarcadora

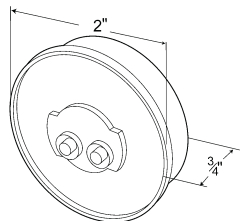

2" CLEARANCE / MARKER LAMP

Fits narrow rails and other tight applications • Hermetic lens-to-housing seal • Twist-on mounting for easy installation • Fits all competitive mounting devices • 12-Volt version features a 12,000+ hour bulb • Meets PC function only when mounted at a 45° angle, recommended bracket 43690

OPTIC LENS:

45822	Red
45822-5	Red, Retail Pack
45823	Yellow
45823-5	Yellow, Retail Pack
45202	Red, 24-Volt
45203	Yellow, 24-Volt

OPTIC LENS KITS:

45062	Red (45822 + 92120 + 67050)
45063	Yellow (45823 + 92120 + 67050)
45562	Red (45822 + 43150)
45563	Yellow (45823 + 43150)

ABS LAMP:

78333	Yellow
--------------	--------

Material: Polycarbonate
 FMVSS: P2, P3, PC, PC2
 Finish: Red / Yellow
 Bulb: 2 CP Volts / Amps: 12V / .33A
 Bulb: 3 CP Volts / Amps: 24V / .17A
 Bracket: 43690, 43150, 43152, 43153, 43532, 49140, 43760, 42180, 42150, 42192, 42193
 Grommet: 92120, 92150, 42030
 Pigtail: 66851, 66850, 67001, 67050, 66800, 66801, 66840



SUPERNOVA® 2" BEEHIVE CLEARANCE / MARKER LED LAMP

Encapsulant potting for total circuit-board protection • Tin-plated, solid-brass terminals are sealed to housing, to resist corrosion and eliminate failure-causing leak paths • Uses same UBS double-seal pigtail as incandescent for a quick Plug-and-Go® retrofit • Hermetic lens-to-housing seal

47212	Red
47213	Yellow

Material: Polycarbonate
 FMVSS: P2
 Finish: Red / Yellow
 Volts / Amps: 12V / .06A
 Bracket: 43690, 49140, 43150, 43152, 43153, 43532, 43760, 42180, 42190, 42192, 42193
 Grommet: 92120, 92150
 Pigtail: 66851, 66850, 67001, 67050, 66800, 66801, 66840

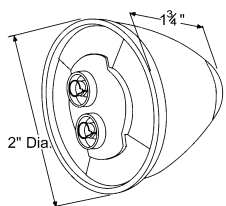

HI COUNT® 2" BEEHIVE LED LAMP

Uses the same UBS double-seal pigtail as the incandescent version for a quick Plug-and-Go® retrofit • Twist-on mounting for easy installation • Concentric, multiple-diode layout • Fits all popular mountings and grommets

G3092	Red
G3092-5	Red, Retail Pack new
G3093	Yellow
G3093-5	Yellow, Retail Pack new

Material: Polycarbonate
 FMVSS: P2
 Finish: Red / Yellow
 Volts / Amps: 12V / .09A
 Bracket: 43690, 49140, 43150, 43152, 43153, 43532, 43760, 42180, 42190, 42192, 42193
 Grommet: 92120, 92150, 42030
 Pigtail: 66851, 66850, 67001, 67050, 66800, 66801, 66840

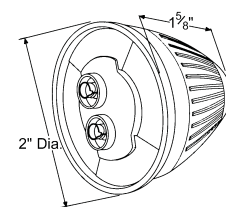

Clearance / Marker Lamps

Feux de Gabarit / Position Lámparas de Gálibo / Demarcadora

13

CLEARANCE / MARKER LAMPS

2" BEEHIVE CLEARANCE / MARKER LAMP

Features a 12,000+ hour bulb • Fits popular grommet and bracket mountings • Hermetic lens-to-housing seal • Twist-on mounting for easy installation • Fits all competitive mounting devices • Meets PC function only when mounted at a 45° angle, recommended bracket 43690

47102 Red
47103 Yellow

Material: Polycarbonate
FMVSS: P2, PC
Finish: Red / Yellow
Bulb: 2 CP Volts / Amps: 12V / .33A
Bracket: 43690, 43150, 43152, 43153, 43532, 49140, 43760, 42180, 42190, 42192, 42193
Grommet: 92120, 92150
Pigtail: 66851, 66850, 67001, 67050, 66800, 66801, 66840

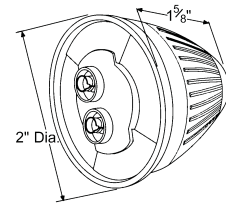

SUPERNOVA® 2 1/2" CLEARANCE / MARKER LED LAMP

Encapsulant potting for total circuit-board protection • Hermetic lens-to-housing seal • Uses same UBS double-seal pigtail as incandescent version for a quick Plug-and-Go® Retrofit Tin-plated, solid-brass terminals are sealed to housing, to resist corrosion and eliminate failure-causing leak paths

47122 Red
47122-5 Red, Retail Pack
47123 Yellow
47123-5 Yellow, Retail Pack
47202 Red w / Black, Theft-Resistant Flange
47322 Red, 24-Volt
47323 Yellow, 24-Volt

KITS:
47472 Red (47122 + 91400 + 67001)
47473 Yellow (47123 + 91400 + 67001)

ABS LAMP:
78423 Yellow

Material: Polycarbonate
FMVSS: P2
Finish: Red / Yellow
Volts / Amps: 12V / .06A
Volts / Amps: 24V / .03A
Bracket: 43690, 43160, 43162, 43163, 43512, 43522, 49140, 93750, 42180, 42170, 42172, 42173
Grommet: 91400, 91410, 92070, 91890, 91880
Pigtail: 67001, 66850, 66851, 66800, 66801, 66840, 67050

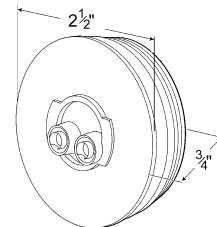

SUPERNOVA® 2 1/2" PC-RATED CLEARANCE / MARKER LED LAMP

Hermetic lens-to-housing seal • Encapsulant potting protects the circuit board from vibration and corrosive particles providing longer life • Uses same UBS double-seal pigtail as incandescent for a quick Plug-and-Go® retrofit

46142 Red **new**
46143 Yellow **new**

Material: Polycarbonate
FMVSS: P2, P3, PC
Finish: Red / Yellow
Volts / Amps: 12V / .06A
Bracket: 43960, 43512, 43522, 43760, 43160, 43162, 43163, 42180, 42170, 42172, 42173
Grommet: 91880, 91890, 91410, 92070, 92920
Pigtail: 67001, 66850, 66851, 66800, 66801, 66840, 67050

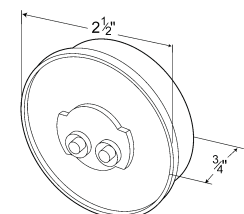

grote.com

13

Clearance / Marker Lamps

Feux de Gabarit / Position Lámparas de Gálíbo / Demarcadora

LED

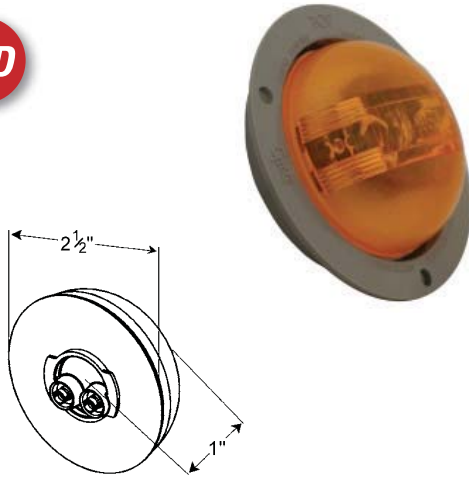

SUPERNOVA® 2 1/2" PC-RATED, CLEARANCE / MARKER LED LAMP

Hermetic lens-to-housing seal • Optic lens optimizes photometric performance and broadens light pattern • Allows use of two fewer lamps, brackets, and pigtails • Encapsulant potting for total circuit-board protection • Uses same UBS double-seal pigtail as incandescent for a quick Plug-and-Go® Retrofit • Tin-plated, solid-brass terminals are sealed to housing, to resist corrosion and eliminate failure-causing leak paths • Available with lamp sealed to flange, for direct mounting in the side of a trailer without creating leaks in the trailer

47232	Red
47233	Yellow
47372	Red w / Gray, Theft-Resistant Flange
47373	Yellow w / Gray, Theft-Resistant Flange

SEALED FLANGE APPLICATIONS:

47423	Yellow w / Black, Theft-Resistant Flange
--------------	--

Material: Polycarbonate
 FMVSS: P2, P3, PC
 Finish: Red / Yellow
 Volts / Amps: 12V / .06A
 Bracket: 43690, 43160, 43162, 43163, 43512, 43522, 49140, 93750, 42180, 42170, 42172, 42173
 Grommet: 91880, 91890, 92920
 Pigtail: 66851, 66850, 67001

LED

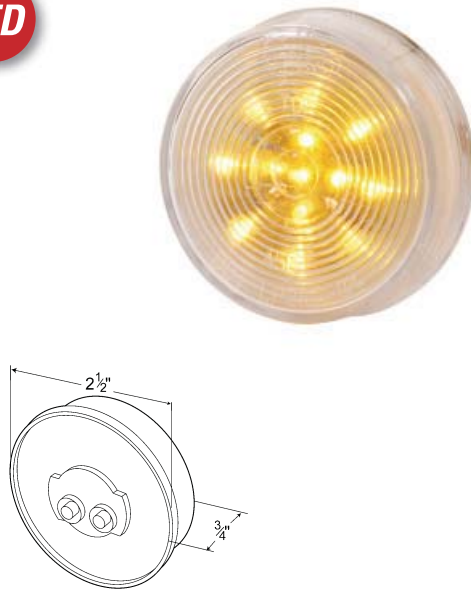

HI COUNT® 2 1/2" LED LAMP

Hermetic lens-to-housing seal • Uses the same UBS double-seal pigtail as the incandescent version for a quick Plug-and-Go® retrofit • Twist-on mounting for easy installation • Concentric, multiple-diode layout • Fits all popular mountings and grommets

OPTIC LENS:

G1032	Red
G1032-5	Red, Retail Pack new
G1033	Yellow
G1033-5	Yellow, Retail Pack new
G1042	Red, Clear Lens new
G1043	Amber, Clear Lens new

BUILT-IN REFLECTOR:

G1002	Red
G1002-5	Red, Retail Pack new
G1003	Yellow
G1003-5	Yellow, Retail Pack new

Material: Polycarbonate
 FMVSS: Optic - P2, Reflex - A, P2
 Finish: Red / Yellow
 Volts / Amps: Optic - 12V / .15A
 Volts / Amps: Reflex - 12V / .13A
 Bracket: 43690, 43160, 43162, 43512, 43163, 93750, 42180, 42170, 42172, 42173
 Grommet: 91400, 91410, 91880, 91890
 Pigtail: 67001, 66850, 66851, 66800, 66801, 66840, 67050

Clearance / Marker Lamps

Feux de Gabarit / Position Lámparas de Gálibo / Demarcadora

15

CLEARANCE / MARKER LAMPS

HI COUNT® 2 1/2" LED LAMP

Hermetic lens-to-housing seal • Uses the same UBS double-seal pigtail as the incandescent version for a quick Plug-and-Go® retrofit • Twist-on mounting for easy installation • Concentric, multiple-diode layout • Fits all popular mountings and grommets

- G1092** Red
- G1093** Yellow
- G1052** Red, Clear Lens **new**
- G1052-5** Red, Clear Lens, Retail Pack **new**
- G1053** Yellow, Clear Lens **new**
- G1053-5** Yellow, Clear Lens, Retail Pack **new**

Material: Polycarbonate
FMVSS: P2
Finish: Red / Yellow
Volts / Amps: 12V / .09A
Bracket: 43690, 43160, 43162, 43512, 43163, 93750, 42180, 42170, 42172, 42173
Grommet: 91400, 91410, 91880, 91890
Pigtail: 67001, 66850, 66851, 66800, 66801, 66840, 67050

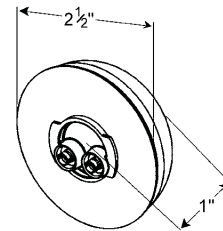

2 1/2" CLEARANCE / MARKER LAMP

Hermetic lens-to-housing seal • Twist-on mounting for easy installation • Fits all competitive and popular mounting devices • 12-Volt version features a 12,000+ hour bulb • Optic version only, meets PC function only when mounted at a 45° angle • Recommended bracket: 43690; grommets: 91880, 91890 or 92920

OPTIC LENS:

- 45812** Red
- 45812-5** Red, Retail Pack
- 45813** Yellow
- 45813-5** Yellow, Retail Pack
- 45182** Red, 24-Volt
- 45183** Yellow, 24-Volt

OPTIC LENS KITS:

- 45042** Red (45812 + 91400 + 67050)
- 45043** Yellow (45813 + 91400 + 67050)
- 45052** Red (45812 + 43690 + 67050)
- 45053** Yellow (45813 + 43690 + 67050)

BUILT-IN REFLECTOR:

- 45832** Red
- 45833** Yellow
- 45222** Red, 24-Volt
- 45223** Yellow, 24-Volt

BUILT-IN REFLECTOR KITS:

- 45072** Red (45832 + 91400 + 67050)
- 45073** Yellow (45833 + 91400 + 67050)

ABS LAMP:

- 78343** Yellow, Optic Lens

Material: Polycarbonate, Acrylic
FMVSS: Optic – P2, P3, PC, PC2; Reflex – A, P2, P3
Finish: Red / Yellow
Bulb: 2 CP Volts / Amps: 12V / .33A
Bulb: 3 CP Volts / Amps: 24V / .17A
Pigtail Retention Cap: Grey 93670
Bracket: 43690, 43160, 43162, 43512, 43163, 93750, 42180, 42170, 42172, 42173
Grommet: 91400, 91880, 91890, 91410, 92070, 92920
Pigtail: 67001, 66850, 66851, 66800, 66801, 66840, 67050

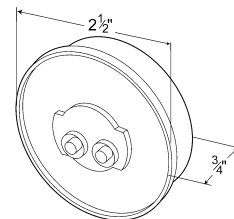

grote.com

15

Clearance / Marker Lamps

Feux de Gabarit / Position Lámparas de Gálíbo / Demarcadora

LED

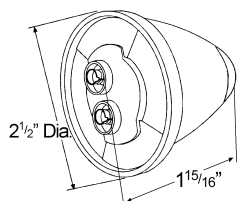

SUPERNOVA® 2 1/2" BEEHIVE, CLEARANCE / MARKER LED LAMP

Encapsulant potting for total circuit-board protection • Tin-plated, solid-brass terminals are sealed to housing, to resist corrosion and eliminate failure-causing leak paths • Uses same UBS double-seal pigtail as incandescent for a quick Plug-and-Go® retrofit • Hermetic lens-to-housing seal

47222 Red
47223 Yellow

Material: Polycarbonate
FMVSS: P2
Finish: Red / Yellow
Volts / Amps: 12V / .06A
Bracket: 43690, 43160, 43162, 43512, 43163, 93750, 42180, 42170, 42172, 42173
Grommet: 91400, 91410, 92070, 91880, 91890
Pigtail: 67001, 66850, 66851, 66800, 66801, 66840, 67050

LED

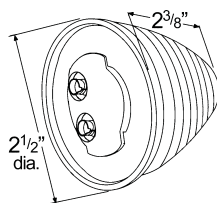

HI COUNT® 2 1/2" BEEHIVE CLEARANCE / MARKER LED LAMP

Hermetic lens-to-housing seal • Twist-on mounting for easy installation • Concentric, multiple-diode layout • Fits all popular mountings and grommets

G1082 Red
G1082-5 Red, Retail Pack **new**
G1083 Yellow
G1083-5 Yellow, Retail Pack **new**

Material: Polycarbonate
Reflective: P2
Finish: Red / Yellow
Volts / Amps: 12V / .09A
Bracket: 43690, 43160, 43162, 43512, 43163, 93750, 42180, 42170, 42172, 42173
Grommet: 91400, 91410, 91880, 91890, 92070
Pigtail: 66800, 66801, 66840, 67050

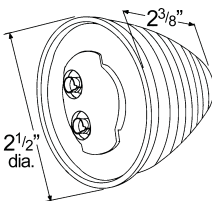

2 1/2" BEEHIVE CLEARANCE / MARKER LAMP

Hermetic lens-to-housing seal • Twist-on mounting for easy installation • Fits all competitive and popular mounting devices • Meets PC function only when mounted on a 45° angle

45322 Red
45323 Yellow

Material: Polycarbonate
Reflective: P2, PC
Finish: Red / Yellow
Bulb: 2 CP
Volts / Amps: 12V / .33A
Bracket: 43690, 43160, 43162, 43512, 43163, 93750, 42180, 42170, 42172, 42173
Grommet: 91400, 91880, 91890, 91410, 92070
Pigtail: 66800, 66801, 66840, 67050

Clearance / Marker Lamps

Feux de Gabarit / Position Lámparas de Gálibo / Demarcadora

17

CLEARANCE / MARKER LAMPS

ROUND SURFACE-MOUNT SINGLE-BULB CLEARANCE / MARKER LAMP

12,000+ hour bulb • Snap-on lens for easy bulb replacement • Heavy-duty 2 CP wedge-base bulb • Flush-mounting • OE Replacement on Mack® MR models • Meets PC function only when mounted at a 45° angle

- 45412** Red
- 45412-5** Red, Retail Pack
- 45413** Yellow
- 45413-5** Yellow, Retail Pack

Material: DURAMOLD® / Acrylic
FMVSS: P2, PC
Finish: White
Bulb: 193, 2 CP Volts / Amps: 12V / .33A
Lens: Red 90162, Yellow 90163

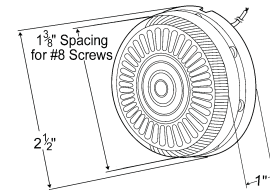

SUPERNOVA® CLEARANCE / MARKER LED LAMP

Encapsulant potting for total circuit-board protection • Hermetic lens-to-housing seal • Tin-plated, solid-brass terminals are sealed to housing, to resist corrosion and eliminate failure-causing leak paths • Uses the same UBS double-seal pigtail as incandescent for a quick Plug-and-Go® retrofit

- 47082** Red
- 47083** Yellow
- 78593** Yellow, ABS **new**

AUXILIARY:

- 47084** Green
- 47085** Blue

Material: Polycarbonate
FMVSS: P2
Finish: Red / Yellow / Green / Blue
Volts / Amps: 12V / .06A
Bracket: 43370, 43970, 43980, 42131
Grommet: 91380
Pigtail: 66851, 66850, 67001, 66800, 66801, 66840, 67050



LED

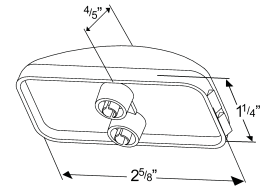

HI COUNT® 3-DIODE LED LAMP

Hermetic lens-to-housing seal • Uses the same UBS double-seal pigtail as the incandescent version for a quick Plug-and-Go® retrofit • High diode count layout • Fits popular mountings and grommets

- G1502** Red
- G1502-5** Red, Retail Pack **new**
- G1503** Yellow
- G1503-5** Yellow, Retail Pack **new**

KITS:

- G1513-5** Yellow (G1503 + 94233 + 91380 + 67001), Retail Pack
- G1512-5** Yellow (G1503 + 94233 + 91380 + 67001), Retail Pack

Material: Polycarbonate
FMVSS: P2
Finish: Red / Yellow
Volts / Amps: 12V / .06A
Bracket: 43370, 43970, 43980, 42131
Grommet: 91380
Pigtail: 66851, 66850, 67001, 66800, 66801, 66840, 67050



LED

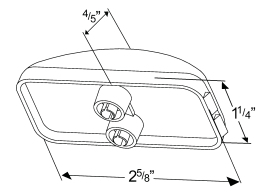

grote.com

17

Clearance / Marker Lamps

Feux de Gabarit / Position Lámparas de Gálíbo / Demarcadora

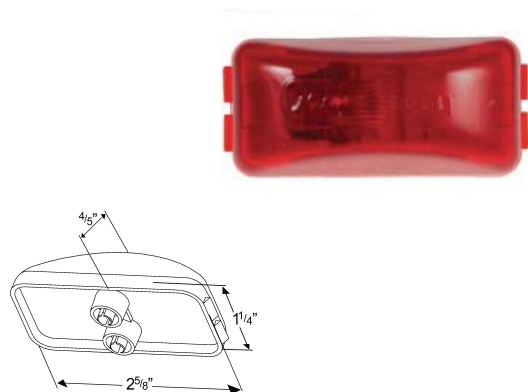

CLEARANCE / MARKER LAMP

Hermetic lens-to-housing seal • 12-Volt version features a 12,000+ hour bulb • Uses double-seal UBS pigtail • Rectangular shape fits narrow applications • Meets PC function only when mounted at a 45° angle, recommend bracket 43370 or 43380

- 46412** Red
46412-5 Red, Pair Pack, Retail Pack
46413 Yellow
46413-5 Yellow, Pair Pack, Retail Pack
45162 Red, 24-Volt ●
45163 Yellow, 24-Volt ●

KITS:

- 45082** Red (46412 + 43970 + 67050)
45083 Yellow (46413 + 43970 + 67050)
47872-5 Red (46412 + 42213 + 70540256)
47873-5 Yellow (46413 + 42213 + 70540256)
65152 Red (46412 + 43380)
65153 Yellow (46413 + 43380)

Material: Polycarbonate
 FMVSS: P2, PC
 Finish: Red / Yellow
 Bulb: 2 CP Volts / Amps: 12V / .33A
 Bulb: 3 CP Volts / Amps: 24V / .17A
 Bracket: 43370, 43970, 43980, 42131, 42213, 42141
 Grommet: 91380
 Pigtail: 66851, 66850, 67001, 66800, 66801, 66840, 67050

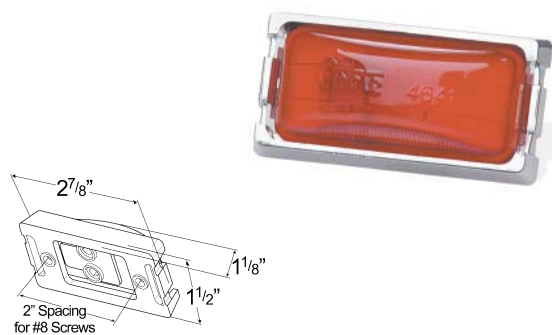

SEALED CLEARANCE / MARKER LAMP AND BRACKET KIT

Features a 12,000+ hour bulb • Kit contains lamp (46412 or 46413), bracket (43980) and pigtail (67050)

- 46422-5** Red, Retail Pack
46423-5 Yellow, Retail Pack

Material: Polycarbonate, ABS
 FMVSS: P2
 Finish: Chrome
 Bulb: 2 CP Volts / Amps: 12V / .33A
 Bracket: 43980
 Pigtail: 67050

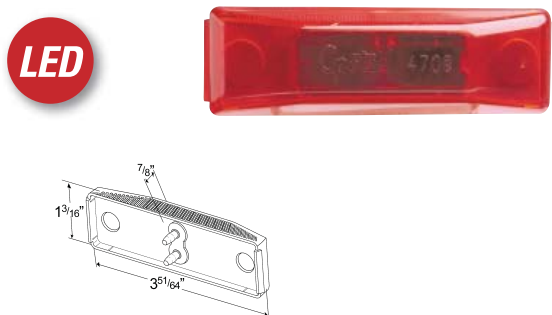

SUPERNOVA® CLEARANCE / MARKER LED LAMP

Encapsulant potting for total circuit-board protection • Hermetic lens-to-housing seal • Advanced pin connection system • Uses same UBS pigtail as incandescent for a quick Plug-and-Go® retrofit • Meets PC function only when mounted at a 45° angle, recommend bracket 43850

- 47092** Red
47093 Yellow
46152 Red, 24-Volt ●
46153 Yellow, 24-Volt ●

KITS:

- 65202** Red (47092 + 43850)
65203 Yellow (47093 + 43850)

PC-RATED:

- 47492** Red
47493 Yellow

Material: Polycarbonate
 FMVSS: 47092, 47093 - P2, 47492, 47493 - P2, PC
 Finish: Red / White
 Volts / Amps: P2 Rated – 12V / .06A
 Volts / Amps: PC-rated – 12V / .12A
 Lamp Guard: 43120
 Bracket: 43780, 43783, 43850
 Pigtail: 66982, 66980, 66981

Clearance / Marker Lamps

Feux de Gabarit / Position Lámparas de Gálibo / Demarcadora

HI COUNT® LED LAMP

Hermetic lens-to-housing seal • Uses the same UBS double-seal pigtail as the incandescent version for a quick Plug-and-Go® retrofit • Concentric multiple-diode layout • Fits all popular mountings and grommets



- G1902** Red
- G1902-5** Red, Retail Pack
- G1903** Yellow
- G1903-5** Yellow, Retail Pack
- G1912** Red, Clear Lens **new**
- G1913** Yellow, Clear Lens **new**

Material: Polycarbonate
 FMVSS: P2
 Finish: Red / Yellow
 Volts / Amps: 12V / .06A
 Lamp Guard: 43120
 Bracket: 43780, 43783, 43850
 Pigtail: 66982, 66980, 66981

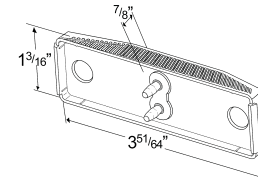

CLEARANCE / MARKER LAMP

Rectangular, double bulb lamp • 12-Volt version features a 12,000+ hour bulb • Narrow mounting applications • Hermetic lens-to-housing seal • Meets PC function only when mounted at a 45° angle, recommended bracket 43850



- 46742** Red
- 46742-5** Red, Retail Pack
- 46743** Yellow
- 46743-5** Yellow, Retail Pack
- 46740** Red and Yellow
- 45142** Red, 24-Volt
- 45143** Yellow, 24-Volt

- KITS:**
- 45092** Red (46742 + 43850)
 - 45093** Yellow (46743 + 43850)

- ABS LAMP:**
- 78393** Yellow

Material: Polycarbonate
 FMVSS: Red and Yellow: P2, P3, PC, PC2; Split Lens: P2
 Finish: Red / Yellow
 Bulb: (2) 2 CP Volts / Amps: 12V / .66A
 Bulb: (2) 3 CP Volts / Amps: 24V / .34A
 Lamp Guard: 43120
 Bracket: 43850, 43780, 43783
 Pigtail: 66980, 66982, 66981

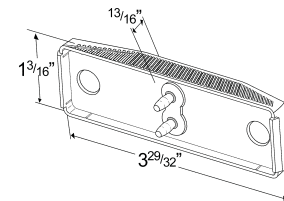

2 1/2" OVAL CLEARANCE / MARKER LED LAMP

Low-amp draw of LED lamps makes these ideal in applications where power supply is limited or where several lamps are used • Surface-mount design makes these lamps easy to install • Self-grounding eyelet grounds lamp when attached to metal plate



- 45002-5** Red, Retail Pack
- 45003-5** Yellow, Retail Pack
- 45242-5** Red, Clear Lens
- 45243-5** Yellow, Clear Lens

- SELF GROUNDING:**
- 47012** Red
 - 47013** Yellow

Material: Polycarbonate
 FMVSS: P2, P3
 Finish: Black
 Volts / Amps: 12V / .05A
 Bezel: 43883
 Grommet: 91060

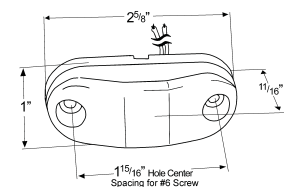

Clearance / Marker Lamps

Feux de Gabarit / Position Lámparas de Gálíbo / Demarcadora

LED

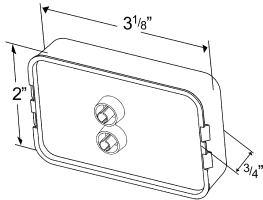

SUPERNOVA® CLEARANCE / MARKER LED LAMP

Encapsulant potting for total circuit-board protection • Hermetic lens-to-housing seal • Tin-plated, solid-brass terminals are sealed to housing, to resist corrosion and eliminate failure-causing leak paths • Fits competitive grommets and pigtails • OE replacement for Knapheide*

47502 Red
47503 Yellow

Material: Polycarbonate / Acrylic
FMVSS: A, P2
Finish: Red / Yellow
Volts / Amps: 12V / .06A
Grommet: 93400, 93402
Pigtail: 66851, 66850, 67001, 67050, 66800, 66840, 66801

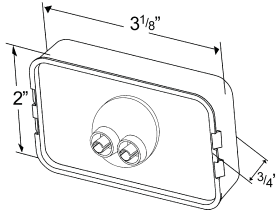
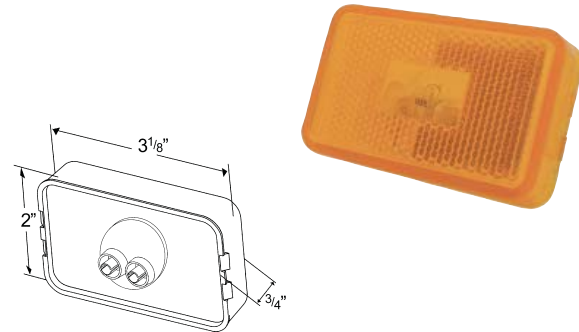

CLEARANCE / MARKER LAMP

Fits popular grommets, pigtails and harnesses • OE replacement for Knapheide* • Hermetic lens-to-housing seal • 12,000+ hour bulb

45232 Red
45233 Yellow

Material: Polycarbonate / Acrylic
FMVSS: A, P2
Finish: White
Bulb: 2 CP Volts / Amps: 12V / .33A
Grommet: 93400, 93402
Pigtail: 66851, 66850, 67001, 67050, 66800, 66840, 66801

LED



47983



47963



47952

MICRONOVA® CLEARANCE / MARKER LED LAMP

Low, 1/2" profile makes lamp less susceptible to damage • Small size fits in narrow applications • Hermetic lens-to-housing seal • Encapsulant potting for total circuit-board protection against vibration and corrosion • Available in PC version (meets PC when mounted at 45° angle) • Sleek aerodynamic styling • Grommet mount versions have no exposed fasteners

47952 Red w / Chrome Bezel
47952-5 Red w / Chrome Bezel, Retail Pack **new**
47982 Red, Clear Lens w / Chrome Bezel
47953 Yellow w / Chrome Bezel
47953-5 Yellow w / Chrome Bezel, Retail Pack **new**
47983 Yellow, Clear Lens w / Chrome Bezel
47962 Red w / Grommet
47962-5 Red w / Grommet, Retail Pack **new**
47963 Yellow w / Grommet
47963-5 Yellow w / Grommet, Retail Pack **new**

PC-RATED:

45282 Red w / Chrome Bezel
45283 Yellow w / Chrome Bezel
47972 Red w / Grommet
47973 Yellow w / Grommet

Material: Polycarbonate / ABS
FMVSS: P2, PC rated (45282, 45283, 47972, 47973) – PC
Finish: Red / Yellow / Chrome
Volts / Amps: 12V / .05A
Accessory: Chrome Bezel 93803, Mounting Gasket: 94220
Bracket: 42110

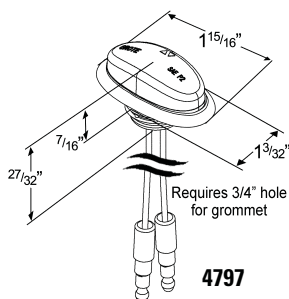

47972

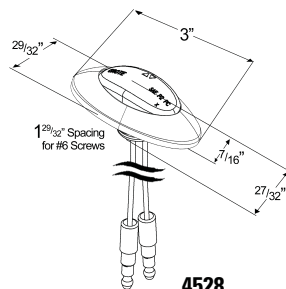

45282
47952
47952-5
47982

Clearance / Marker Lamps

Feux de Gabarit / Position Lámparas de Gálibo / Demarcadora

SUPERNOVA® 3" CENTER THIN-LINE CLEARANCE / MARKER LED LAMP

3" mounting center • Field-replaceable lens • Encapsulant potting for total circuit-board protection • Anti-torque design protects against over-tightening and lens cracking • Wire exit holes at ends allow for flow-through harnessing • Meets PC function only when mounted at a 45° angle

- 47242 Red
- 47243 Yellow
- 47362 Red, 24-Volt
- 47363 Yellow, 24-Volt

KITS:	
65512	Red (47242 + 66930)
65513	Yellow (47243 + 66930)

PC-RATED:	
47462	Red
47463	Yellow

ABS LAMP:	
78453	Yellow

Material: Polycarbonate
 FMVSS: P2, PC-rated (47462 / 47463) – PC
 Finish: Red / Yellow
 Volts / Amps: 47242, 47243, 78453 – 12V / .06A
 Volts / Amps: 47462, 47463 – 12V / .12A
 Volts / Amps: Red – 24V / .03A
 Volts / Amps: Yellow – 24V / .04A
 Bracket: 43230
 Pigtail: 66931, 66930, 66932
 Lens: Red 92942, Yellow 92943, PC Red 93412, Yellow 93413

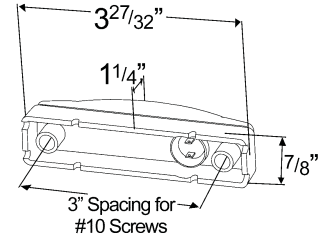

SUPERNOVA® 3" CENTER DUAL-INTENSITY CLEARANCE / MARKER LED LAMP

Multi-function lamp for improved safety • Compact size for tight-rail real estate • Lamp functions as a marker, clearance, identification and supplemental high mount stop or turn lamp. • Long-life lamp features replaceable lens and a circuit board encapsulated in hard-shell potting to protect against vibration and water intrusion.

- 49252 Red new
- 49253 Yellow new

Material: Polycarbonate
 FMVSS: P2, U
 Finish: Red / Yellow
 Volts / Amps: 14V / .02A / .06A
 Pigtail: 66870
 Lens: 92942, 92943

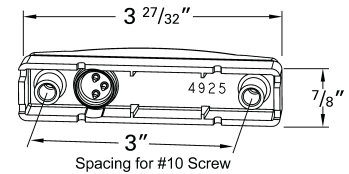

Clearance / Marker Lamps

Feux de Gabarit / Position Lámparas de Gálibo / Demarcadora

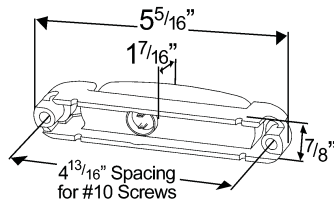

SUPERNOVA® THIN-LINE CLEARANCE / MARKER LED LAMP

Sealed marker lamp • Encapsulant potting for total circuit-board protection
 • Thin-line design fits narrow rails and channels • Uses UBS double-seal pigtail for maximum protection against corrosion • Turtleback® design for maximum durability

46902	Red Lens, White Body
46903	Yellow Lens, White Body
46922	Red Lens, Red Body
46933	Yellow Lens, Yellow Body

KITS:

45132	Red Lens, White Body (46902 + 66930)
45133	Yellow Lens, White Body (46903 + 66930)
45102	Red Lens, Red Body (46922 + 66930)
45103	Yellow Lens, Yellow Body (46933 + 66930)

Material: Polycarbonate
 FMVSS: P2
 Finish: White / Red / Yellow
 Volts / Amps: 12V / .07A
 Bracket: 43074
 Pigtail: 66931, 66930, 66932

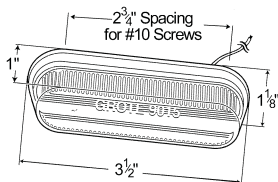

THIN-LINE SINGLE-BULB CLEARANCE / MARKER LAMP

Narrow rail and channel-mounting • Snap-on lens for easy bulb replacement • Attached pigtail

45252	Red
45252-5	Red, Retail Pack
45253	Yellow
45253-5	Yellow, Retail Pack

WITH GROUND WIRE:

45672	Red
45673	Yellow

Material: DURAMOLD® / Acrylic
 FMVSS: P2
 Finish: Red / Yellow
 Bulb: 193, 2 CP Volts / Amps: 12V / .33A
 Lens: Red 90152, Yellow 90153

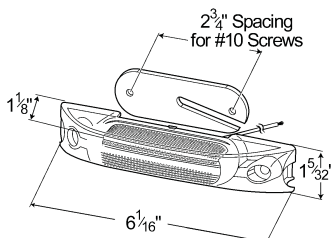

TURTLEBACK® THIN-LINE SINGLE-BULB CLEARANCE / MARKER LAMP

Turtleback® lens design for maximum durability • Narrow rail and channel-mounting • Attached pigtail

45382	Red
45383	Yellow

Material: DURAMOLD® / Polycarbonate
 FMVSS: P2, P3
 Finish: Red / Yellow
 Bulb: 193, 2 CP Volts / Amps: 12V / .33A
 Lens: Red 90142, Yellow 90143

CLEARANCE / MARKER LAMP WITH PEAK LENS

Shock-resistant bulb mount • Snap-on lens for easy bulb replacement
 • OE Replacement part for U-Haul[®] and Stoughton[®] • Meets PC function only when mounted at a 45° angle

BLUNT CUT:

- 45512** Red
- 45512-5** Red, Retail Pack
- 45513** Yellow
- 45513-5** Yellow, Retail Pack

.180 MALE BULLET TERMINATION:

- 45522** Red
- 45523** Yellow

Material: Polycarbonate
 FMVSS: P2, PC
 Finish: Red / Yellow
 Bulb: 194, 2 CP Volts / Amps: 12V / .27A
 Lens: Red 93252

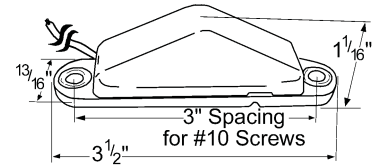

ECONOMY CLEARANCE / MARKER LAMP

Push-on lens for easy bulb replacement • Brass, ground eyelet • Compact design
 • Interchangeable with competitive models • Tailgate / running board kit contains 6 lamps, mounting hardware and wiring connectors

- 46882** Red
- 46882-5** Red, Retail Pack
- 46883** Yellow
- 46883-5** Yellow, Retail Pack

TAILGATE / RUNNING BOARD KITS:

- 65092-5** Red, Retail Pack
- 65093-5** Yellow, Retail Pack

Material: DURAMOLD[®] / Acrylic
 FMVSS: P2
 Finish: Red / Yellow
 Bulb: 194, 2 CP Volts / Amps: 12V / .27A
 Lens: Red 92432, Yellow 92433

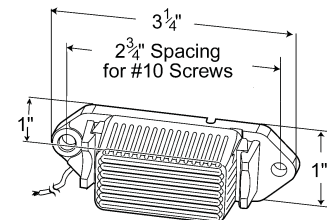

RECTANGULAR SINGLE-BULB CLEARANCE / MARKER LAMP WITH BUILT-IN REFLECTOR

Corrosion-resistant body • Flange mounting • Boat, snowmobile, trailer and RV applications • Built-in reflector

- 46392-5** Red, Retail Pack
- 46393-5** Yellow, Retail Pack

REPLACEMENT PARTS:

- 46392** Red
- 46393** Yellow

Material: DURAMOLD[®] / Acrylic
 FMVSS: A, P2, P3
 Finish: Black
 Bulb: 1895, 2 CP Volts / Amps: 12V / .27A
 Lens: Red 91112, Yellow 91153

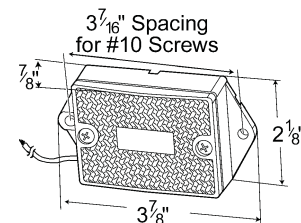

Clearance / Marker Lamps

Feux de Gabarit / Position L mparas de G libo / Demarcadora

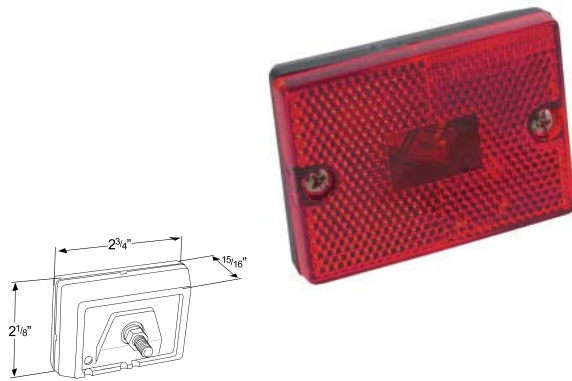

RECTANGULAR, SUBMERSIBLE CLEARANCE MARKER LAMP

Popular design • Used with a large variety of boat, snowmobile and utility trailer lighting kits

REPLACEMENT PARTS:

- 46982-5** Red, Clearance / Marker, Retail Pack
46983-5 Yellow, Clearance / Marker, Retail Pack

Material: DURAMOLD®
 FMVSS: P2
 Finish: Red / Yellow
 Bulb: 1895, 2 CP Volts / Amps: 12V / .27A



RECTANGULAR CLEARANCE / MARKER LAMP

Chrome-plated, DURAMOLD® housing • 2" mounting centers
 • 1 1/8" socket hole required • Universal uses: interior, courtesy or trunk applications

- 47052** Red
47053 Yellow

AUXILIARY:

- 47051** Clear

Material: DURAMOLD® / Acrylic
 FMVSS: P2
 Finish: Chrome
 Bulb: 1895, 2 CP Volts / Amps: 12V / .27A
 Lens: Clear 92691, Red 92692, Yellow 92693

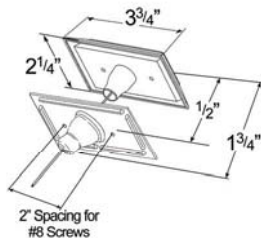

SINGLE-BULB OVAL CLEARANCE / MARKER LAMP

Low profile • Corrosion-resistant contact and ground • Reflex lamp is a reflector, clearance lamp or sidemarker lamp combined • Lamp comes with pigtail

OPTIC LENS:

- 46702** Red
46702-5 Red, Retail Pack
46703 Yellow
46703-5 Yellow, Retail Pack

BUILT-IN REFLECTOR:

- 46712** Red
46712-5 Red, Retail Pack
46713 Yellow
46713-5 Yellow, Retail Pack

Material: DURAMOLD® / Acrylic
 FMVSS: Optic – P2; Reflex – A, P2
 Finish: White
 Bulb: 193, 2 CP Volts / Amps: 12V / .33A
 Bracket: 43144, 43673
 Lens: Optic – Red 90122, Yellow 90123; Reflex – Red 90202, Yellow 90203

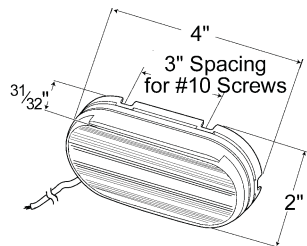

TWO-BULB OVAL PIGTAIL-TYPE CLEARANCE / MARKER LAMP

Standard snap-on lens for easy bulb replacement • Two stainless-steel grounds • Exclusive internal armor for additional bulb protection

- Corrosion-resistant contacts
- Reflex version is a side marker, clearance lamp and reflector combined
- Meets PC function only when mounted at a 45° angle

OPTIC LENS:

45262	Red
45262-5	Red, Retail Pack
45263	Yellow
45263-5	Yellow, Retail Pack

BUILT-IN REFLECTOR:

45932	Red
45932-5	Red, Retail Pack
45933	Yellow
45933-5	Yellow, Retail Pack

Material: DURAMOLD® / Acrylic, Polycarbonate
 FMVSS: Optic: P2, PC; Reflex – A, P2
 Finish: Red / Yellow
 Bulb: (2) 1893, 2 CP Volts / Amps: 12V / .66A
 Bracket: 43144, 43673
 Pigtail: 67120
 Lens: Optic – Red 91572, Yellow 91573; Reflex – Red 90202, Yellow 90203

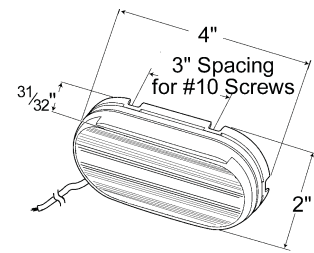

TWO-BULB NO-SPLICE CLEARANCE / MARKER LAMP

Exclusive, no-splice wiring system • Exclusive, internal armor for additional protection • Standard snap-on lens for easy bulb replacement • Meets PC function only when mounted at a 45° angle

45432	Red
45433	Yellow

Material: DURAMOLD® / Polycarbonate
 FMVSS: P2, P3, PC, PC2
 Finish: White
 Bulb: (2) 1893, 2 CP Volts / Amps: 12V / .66A
 Bracket: 43144, 43673
 Lens: Red 91572, Yellow 91573

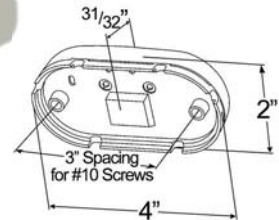

FRUEHAUF® SPECIAL CLEARANCE / MARKER LAMP

Fluted optics for wide light dispersion • Molded T-terminal wiring connection for easy replacements • Replaces Fruehauf® L-CE8750 and competitive versions • Meets PC function only when mounted at a 45° angle

46772	Red
46773	Yellow

Material: DURAMOLD® / Acrylic
 FMVSS: P2, PC
 Finish: White
 Bulb: (2) 1893, 2 CP Volts / Amps: 12V / .66A
 Bracket: 43144, 43673
 Pigtail: 67120
 Lens: Red 91992, Yellow 91993

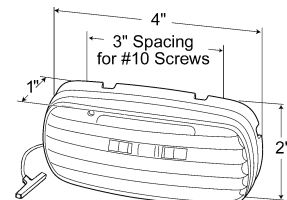

Clearance / Marker Lamps

Feux de Gabarit / Position Lámparas de Gálíbo / Demarcadora

LED

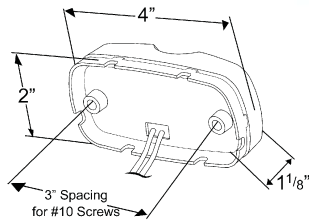

HI COUNT® SQUARE-CORNER LED LAMP

Molded snap-ring • Encapsulent potting circuit board for total protection against moisture and vibration • Field-replaceable lens

- G4602** Red
- G4602-5** Red, Retail Pack
- G4612** Red, Clear Lens / Base **new**
- G4603** Yellow
- G4603-5** Yellow, Retail Pack
- G4613** Yellow, Clear Lens / Base **new**

Material: Polycarbonate / Acrylic
 FMVSS: P2
 Finish: Red / Yellow
 Volts / Amps: 12V / .15A
 Bracket: 43144, 43673
 Lens: Red 91962, Yellow 91963; Auxiliary: Clear 91961

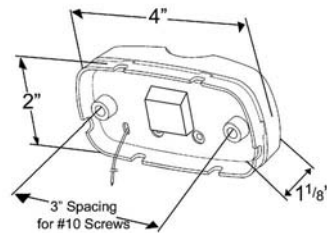

DURAMOLD® TWO-BULB SQUARE-CORNER CLEARANCE / MARKER LAMP

Corrosion-resistant contacts • Snap-on lens for easy bulb replacement
 • Attached blunt-cut pigtail • Meets PC function only when mounted at a 45° angle

- 46792** Red
- 46792-5** Red, Retail Pack
- 46793** Yellow
- 46793-5** Yellow, Pair Pack

Material: DURAMOLD® / Acrylic
 FMVSS: P2, P3, PC
 Finish: Red / Yellow
 Bulb: (2) 1893, 2 CP Volts / Amps: 12V / .66A
 Bracket: 43144, 43673
 Pigtail: 67120
 Lens: Red 91962, Yellow 91963; Auxiliary: Clear 91961, Green 91964, Blue 91965

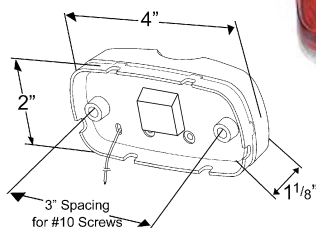

DIE-CAST TWO-BULB SQUARE-CORNER CLEARANCE / MARKER LAMP

Shock-absorbent bulb mounting • Lubricated fleet-service bulb • Meets PC function only when mounted at a 45° angle

- 46782** Red
- 46783** Yellow

Material: Zinc Die-Cast / Acrylic
 FMVSS: P2, P3, PC
 Bulb: (2) 1893, 2 CP Volts / Amps: 12V / .66A
 Accessory: O Ring 94110
 Bracket: 43144, 43673
 Pigtail: 67120
 Lens: Red 91962, Yellow 91963; Auxiliary: Clear 91961, Green 91964, Blue 91965

M1 SERIES CLEARANCE / MARKER LED LAMP

Sleek, aerodynamic styling • Hermetic lens-to-housing seal • Corrosion-resistant, chrome-plated bezels • No exposed fasteners • Molded bullet kits come with two replacement mating connectors • Encapsulment potting for total circuit-board protection

LAMP KITS W / BEZEL:

45582	Red, .180 Molded Bullet
45583	Yellow, .180 Molded Bullet
47772	Red, Clear Lens, .180 Molded Bullet
47773	Yellow, Clear Lens, .180 Molded Bullet
45603	Yellow, Metri-Pack® Plug

LAMP KITS W / O BEZEL:

45622	Red, .180 Molded Bullet
45623	Yellow, .180 Molded Bullet
45642	Red, Metri-Pack® Plug
45643	Yellow, Metri-Pack® Plug

Material: Polycarbonate / ABS
 FMVSS: P2
 Finish: Chrome
 Volts / Amps: 12V / .12A
 Accessory: Chrome Bezel 93453
 Bracket: 93623, 93633, 93643
 Pigtail: 66200

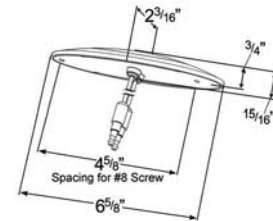

M1 SERIES CLEARANCE / MARKER LAMP

Sleek, aerodynamic styling • Molded bullet versions are bulb replaceable • Corrosion-resistant, chrome-plated bezels • No exposed fasteners • Metri-Pack® versions have a hermetic lens-to-housing seal

LAMP KITS W / BEZEL:

45572	Red, .180 Molded Bullet
45573	Yellow, .180 Molded Bullet
45593	Yellow, Metri-Pack® Plug

LAMP KITS W / O BEZEL:

45612	Red, .180 Molded Bullet
45613	Yellow, .180 Molded Bullet
45633	Yellow, Metri-Pack® Plug

Material: Polycarbonate / ABS
 FMVSS: P2
 Finish: Chrome
 Bulb: 193, 2 CP Volts / Amps: 12V - .33A
 Bulb: 464, 3 CP Volts / Amps: 24V - .17A
 Accessory: Chrome Bezel 93453
 Socket Kit: .180 Molded Bullet - 94190
 Metri-Pack® Plug - 94200, Housing: 93540
 Bracket: 93623, 93633, 93643
 Pigtail: 66200
 Lens: Red 93532, Yellow 93533; Auxiliary: Clear 93531

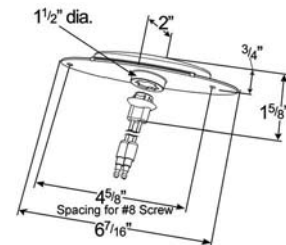

Clearance / Marker Lamps

Feux de Gabarit / Position Lámparas de Gálíbo / Demarcadora

LED

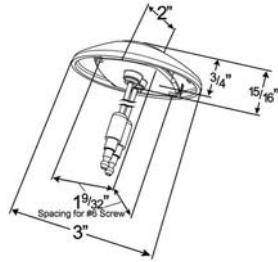

M3 SERIES CLEARANCE / MARKER LED LAMP

Sleek, aerodynamic styling • Hermetic lens-to-housing seal • Corrosion-resistant chrome-plated bezels • No exposed fasteners • Encapsulant potting for total circuit-board protection against vibration and corrosion • Kits contain two replacement mating connectors

LAMP KITS W / BEZEL:

45772 Red, .180 Molded Bullet
45773 Yellow, .180 Molded Bullet

LAMP KITS W / O BEZEL:

45792 Red, .180 Molded Bullet
45793 Yellow, .180 Molded Bullet

Material: Polycarbonate / ABS
 FMVSS: P2
 Finish: Chrome
 Volts / Amps: 12V / .06A
 Accessory: Chrome Bezel 93473
 Pigtail: 66200

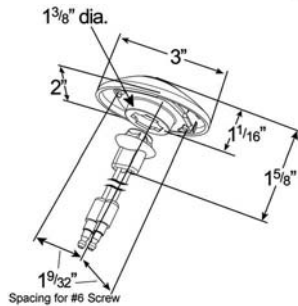

M3 SERIES CLEARANCE / MARKER LAMP

Sleek, aerodynamic styling • Field-replaceable, bulb design • Corrosion-resistant chrome-plated bezels • No exposed fasteners

LAMP KITS W / BEZEL:

45762 Red, .180 Molded Bullet
45763 Yellow, .180 Molded Bullet

LAMP KITS W / O BEZEL:

45783 Yellow, .180 Molded Bullet

Material: Polycarbonate / ABS
 FMVSS: P2
 Finish: Chrome
 Bulb: 193, 2 CP Volts / Amps: 12V / .33A
 Accessory: Chrome Bezel 93473
 Pigtail: 66200
 Lens: Red 93652, Yellow 93653; Auxiliary: Clear 93651

LED

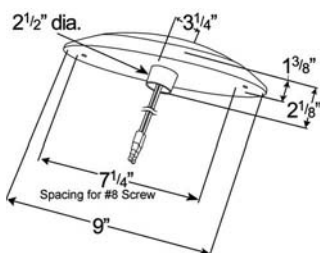

M4 SERIES MARKER LED LAMP

Sleek, aerodynamic styling • Hermetic lens-to-housing seal • Corrosion-resistant chrome-plated bezels • No exposed-fasteners • Kits contain replacement mating connectors

LAMP KITS W / BEZEL:

45853 Yellow, .180 Molded Bullet

Material: Polycarbonate / ABS
 FMVSS: P2
 Finish: Chrome
 Volts / Amps: 12V / .12A
 Accessory: Chrome Bezel 93483
 Pigtail: 66200

M5 SERIES CLEARANCE / MARKER LED LAMP

Sleek, aerodynamic styling small size fits into narrow applications
 • Hermetic lens-to-housing seal • Corrosion-resistant chrome-plated bezels • No exposed fasteners • Encapsulant potting for total circuit-board protection against moisture and corrosion • Kits contain two replacement mating connectors

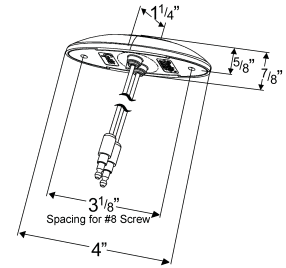

LAMP KITS W / BEZEL:

- 47912** Red, .180 Molded Bullet
- 47913** Yellow, .180 Molded Bullet
- 47922** Red, Clear Lens, .180 Molded Bullet
- 47923** Yellow, Clear Lens, .180 Molded Bullet

Material: Polycarbonate / ABS
 FMVSS: P2
 Finish: Chrome
 Accessory: Chrome Bezel 93713
 Pigtail: 66200

SUPERNOVA® LOW-PROFILE CLEARANCE / MARKER LED LAMP

Encapsulant potting for total circuit-board protection • Sealed hard-wire terminations with .180 molded, UBS slim-line bullets • Field-replaceable lens • Requires 1 1/4" hole for mounting • Popular marker lamp on Peterbilt® trucks; also cab and sleeper trim • Built-in reflector

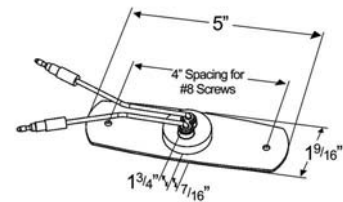

WITHOUT BEZEL:

- 47262** Red
- 47263** Yellow

WITH BEZEL:

- 47252** Red
- 47253** Yellow

Material: DURAMOLD®, Stainless-Steel / Acrylic
 FMVSS: A, P2
 Finish: Stainless / Red / Yellow
 Volts / Amps: 12V / .06A
 Lens: Red 90072, Yellow 90073

LOW-PROFILE CLEARANCE / MARKER LAMP

Field-replaceable lens • Requires 1 1/4" socket hole for mounting
 • Twist-in bulb socket for easy bulb replacement • Built in reflector

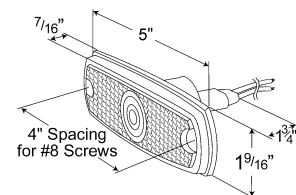

WITHOUT BEZEL:

- 45712** Red
- 45713** Yellow

WITH BEZEL:

- 45662** Red
- 45663** Yellow

Material: DURAMOLD®, Stainless-Steel / Acrylic
 FMVSS: A, P2
 Finish: Stainless / Red / Yellow
 Bulb: 194, 2 CP Volts / Amps: 12V / .27A
 Pigtail: 68380
 Lens: Red 90072, Yellow 90073

Clearance / Marker Lamps

Feux de Gabarit / Position Lámparas de Gálíbo / Demarcadora

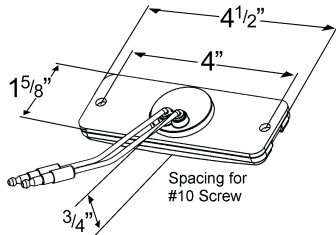

SEALED RECTANGULAR CLEARANCE / MARKER LED LAMP

Encapsulant potting for total circuit-board protection against moisture and corrosion • Hermetic lens-to-housing seal • Fits standard mounting holes, no bracket required • Uses same .180 molded bullet terminations as incandescent versions for a quick, easy retrofit • Replaces Truck-Lite® 18050R (red) or 18050Y (yellow)

WITHOUT BEZEL:

47732	Red
47733	Yellow

WITH BEZEL:

47992	Red
47993	Yellow

Material: Acrylic
FMVSS: A, P2
Finish: Red / Yellow
Volts / Amps: 12V / .06A
Bezel 93813

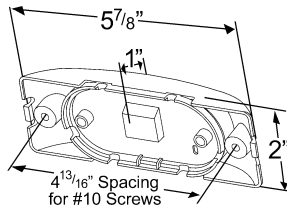

TWO-BULB TURTLEBACK® CLEARANCE / MARKER LAMP

Turtleback® lens design for maximum durability
• Two stainless-steel grounds

OPTIC LENS:

45462	Red
45463	Yellow

BUILT-IN REFLECTOR:

46302	Red
46303	Yellow

Material: DURAMOLD® / Polycarbonate
FMVSS: Optic – P2; Reflex – A, P2
Finish: Red / Yellow
Bulb: (2) 1893, 2 CP Volts / Amps: 12V / .66A
Pigtail: 67120
Lens: Optic – Red 90172, Yellow 90173; Reflex – Red 91042, Yellow 91043

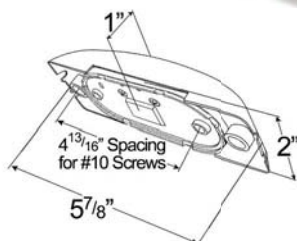

TWO-BULB TURTLEBACK® NO-SPLICE CLEARANCE / MARKER LAMP

Exclusive, no-splice wiring system • Turtleback® lens design for maximum durability • Corrosion-resistant contacts

OPTIC LENS:

45442	Red
45443	Yellow

BUILT-IN REFLECTOR:

46312	Red
46313	Yellow

Material: DURAMOLD® / Polycarbonate
FMVSS: Optic – P2; Reflex – A, P2
Finish: Red / Yellow
Bulb: (2) 1893, 2 CP Volts / Amps: 12V / .66A
Lens: Optic – Red 90172, Yellow 90173; Reflex – Red 91042, Yellow 91043

Clearance / Marker Lamps

Feux de Gabarit / Position Lámparas de Gálibo / Demarcadora

SUPERNOVA® SEALED TURTLEBACK® II CLEARANCE / MARKER LED LAMP

Encapsulant potting for total circuit-board protection • Hermetic lens-to-housing seal • Tin-plated, solid-brass terminals are sealed to housing, to resist corrosion and eliminate failure-causing leak paths • Meets PC function only when mounted at a 45° angle • Not designed for vertical mount

BUILT-IN REFLECTOR:

47072	Red
47073	Yellow
47352	Red, 24-Volt
47353	Yellow, 24-Volt

BUILT-IN REFLECTOR KITS:

47032	Red (47072 + 66910)
47033	Yellow (47073 + 66910)

PC-RATED: (OPTIC LENS)

47162	Red
47163	Yellow

ABS LAMP:

78403	Yellow
--------------	--------

Material: Polycarbonate / Acrylic
 FMVSS: Optic - P2; PC, Reflex - A, P2
 Finish: Red / Yellow
 Volts / Amps: P2 - 12V / .06A
 Volts / Amps: PC - 12V / 0.12A
 Volts / Amps: Red - 24V / .03A
 Volts / Amps: Yellow - 24V / .04A
 Bracket: 43030, 43050 Pigtail: 66911, 66910, 67070, 67071

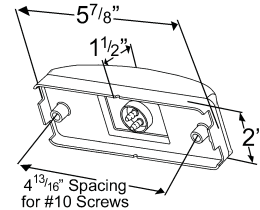

HI COUNT® TURTLEBACK® II LED LAMP

Hermetic lens-to-housing seal • Molded bullet with chassis ground-ring terminal connection • Shock-absorbent, heat-resistant lens and lamp base

G2102	Red
G2102-5	Red, Retail Pack
G2103	Yellow
G2103-5	Yellow, Retail Pack

Material: Polycarbonate / Acrylic
 FMVSS: A, P2
 Finish: Red / Yellow
 Volts / Amps: Red - 12V / .12A
 Volts / Amps: Yellow - 12V / .15A

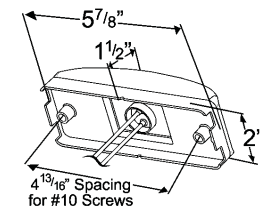

SEALED TURTLEBACK® II CLEARANCE / MARKER LAMP

Shock-absorbent, heat-resistant lens and lamp base • Hermetic lens-to-housing seal • Waterproof male-pin connections accept UBS pigtail • Meets PC function only when mounted at a 45° angle

OPTIC LENS:

46832	Red
46832-5	Red, Retail Pack
46833	Yellow
46833-5	Yellow, Retail Pack

REFLEX LENS:

46872	Red
46872-5	Red, Retail Pack
46873	Yellow
46873-5	Yellow, Retail Pack

ABS LAMP:

78363	Yellow, Optic Lens
--------------	--------------------

Material: Polycarbonate / Acrylic
 FMVSS: Optic - P2, P3, PC; Reflex - A, P2
 Finish: Red / Yellow
 Bulb: (2) 2 CP Volts / Amps: 12V / .66A
 Bracket: 43030, 43050
 Pigtail: 66910, 66911, 67070, 67071

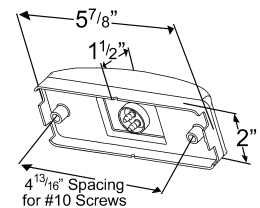

Clearance / Marker Lamps

Feux de Gabarit / Position Lámparas de Gálíbo / Demarcadora

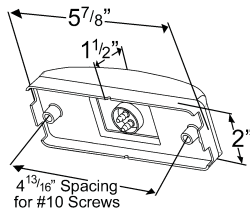

FIELD-RESEALABLE LENS TURTLEBACK® II CLEARANCE / MARKER LAMP

Weather-tight lens gasket seal • Resealable for bulb replacement
 • Impact-resistant bulb contacts • Turtleback® lens design for maximum durability
 • 12-Volt version features two 12,000+ hour bulbs • Meets PC function only when mounted at a 45° angle

OPTIC LENS:

46802 Red
46803 Yellow

REFLEX LENS:

46862 Red
46863 Yellow
46342 Red, 24-Volt ●
46343 Yellow, 24-Volt ●

Material: Polycarbonate / Acrylic
 FMVSS: Optic – P2, P3, PC, PC2; Reflex – A, P2
 Finish: Red / Yellow
 Bulb: (2) 193, 2 CP Volts / Amps: 12V / .66A
 Bulb: (2) 464, 3 CP Volts / Amps: 24V / .34A
 Bracket: 43030, 43050
 Pigtail: 66911, 66910, 67070, 67071
 Lens: Optic - Red 92162, Yellow 92163; Reflex - Red 92172, Yellow 92173

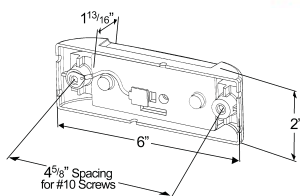

ECONOMY SEALED CLEARANCE / MARKER LAMP

Hermetic lens-to-housing seal • 12,000 hour bulb • Self-grounding
 eyelet grounds lamp when attached to a metal plate • Retrofits to
 competitor lamps easily with hot-wire termination • Interchanges with
 Truck-Lite® 21201R (red) or 21201Y (yellow) • Built-in reflector

46072 Red
46073 Yellow

KITS:

46082 Red (46072 + 66360)
46083 Yellow (46073 + 66360)

Material: Acrylic
 FMVSS: A, P2
 Finish: Red / Yellow
 Bulb: 2 CP Volts / Amps: 12V / .33A
 Pigtail: 66360

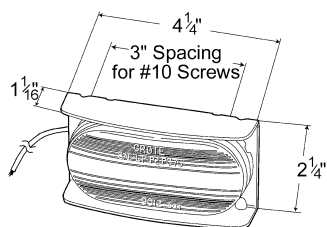

ECONOMY STEEL-ARMORED CLEARANCE / MARKER LAMP

Corrosion-proof, shock-absorbent lamp base • External guard of
 formed steel for additional lamp protection • Snap-on lens for easy
 bulb replacement • Flat back; no need for lamp socket hole • Meets
 PC function only when mounted at a 45° angle

46492-5 Red, Retail Pack
46493-5 Yellow, Retail Pack

Material: Steel, DURAMOLD® / Acrylic
 FMVSS: P2, PC
 Finish: Red / Yellow / Gray
 Bulb: 193, 2 CP Volts / Amps: 12V / .33A
 Bracket: 43144
 Lens: Red 90122, Yellow 90123

Clearance / Marker Lamps

Feux de Gabarit / Position Lámparas de Gálibo / Demarcadora

SMALL SQUARE PC-RATED LAMP

Direct replacement for Truck-Lite® 12200R (red) or 12200Y (yellow)
 • Standard lamps on UPS • Service life rated at 15,000 • Comes with gasket • Sonic sealed lens

46092 Red

Material: Polycarbonate
 FMVSS: P2, PC
 Finish: Red
 Bulb: 2 CP Volts / Amps: 12V / .33A

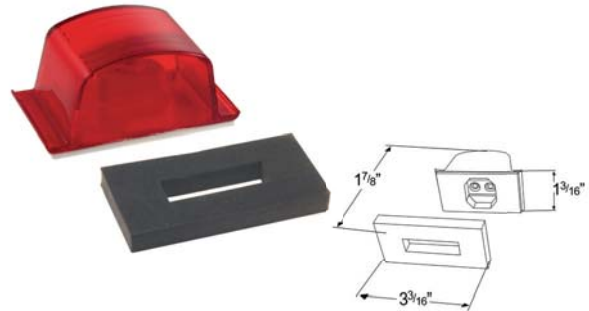

DIE-CAST, ALUMINUM CLEARANCE / MARKER LAMP

Mounts without disassembly • Holes interchange with competitive lamps for easy retrofits • Lens replaces comparable competitor models • Meets PC function only when mounted at a 45° angle

REAR SOCKET:

46292 Red
46293 Yellow

FLAT BACK, NO SOCKET HOLE REQUIRED:

46282 Red
46283 Yellow

Material: Aluminum / Acrylic
 FMVSS: P2, PC
 Finish: Red / Yellow / Gray
 Bulb: 46292, 46293: 67, 4 CP Volts / Amps: 12V / .59A
 Bulb: 46282, 46283: 193, 2 CP Volts / Amps: 12V / .33A
 Lens: Red 90922, Yellow 90923

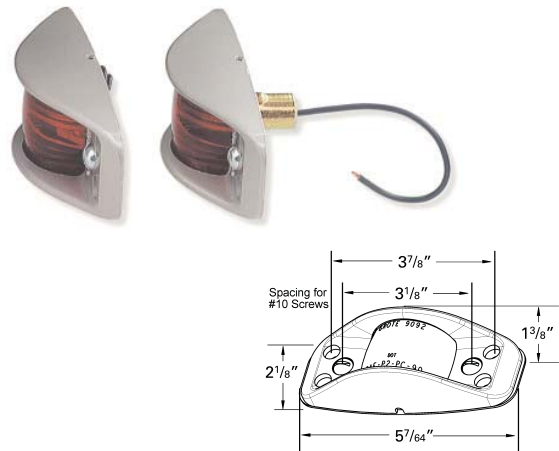

NARROW-RAIL CLEARANCE / MARKER LAMP

Seal-tight expanded rubber gasket • Steel housing for additional lamp protection • Two- or four- hole mounting for easy retrofits • Flat back; no need for lamp socket hole • Meets PC function only when mounted at a 45° angle

45172 Red
45173 Yellow

Material: Steel / Acrylic
 FMVSS: P2, P3, PC
 Finish: Red / Yellow / Gray
 Bulb: 193, 2 CP Volts / Amps: 12V / .33A
 Lens: Red 90052, Yellow 90053; Auxiliary: Clear 90051

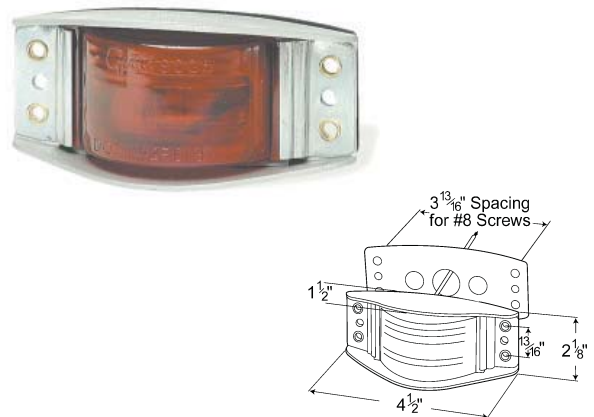

ARMORED CLEARANCE / MARKER LAMP

Seal-tight, expanded rubber gasket • Steel housing for additional lamp protection • Two- or four- hole mounting for easy retrofits • Rear socket hole required • Meets PC function only when mounted at a 45° angle

45012 Red
45013 Yellow

Material: Steel / Acrylic
 FMVSS: P2, P3, PC, PC2
 Finish: Red / Yellow / Gray
 Bulb: 67, 4 CP Volts / Amps: 12V / .59A
 Pigtail: 68080
 Lens: Red 90052, Yellow 90053; Auxiliary: Clear 90051

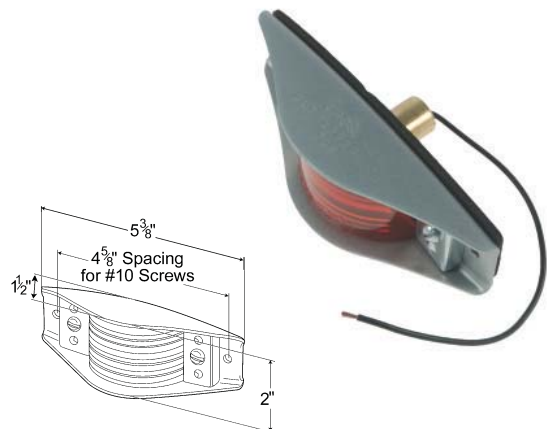

Clearance / Marker Lamps

Feux de Gabarit / Position L mparas de G libo / Demarcadora

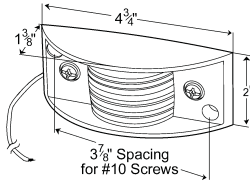

CHROME-ARMORED CLEARANCE / MARKER LAMP

Direct interchange for competitive models • Flat back; no bulb socket hole required • Meets PC function only when mounted at a 45° angle

- 46892** Red
- 46892-5** Red, Retail Pack
- 46893** Yellow
- 46893-5** Yellow, Retail Pack

Material: DURAMOLD® / Acrylic
 FMVSS: P2, PC
 Finish: Chrome / Red / Yellow
 Bulb: 194, 2 CP Volts / Amps: 12V / .27A
 Lens: Red 90922, Yellow 90923

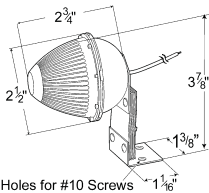

BEEHIVE LAMP WITH FLEXIBLE WEB STRAP

Wide light diffusion; optic design • Web strap provides deflection without breaking lamp • Fade-resistant, snap-on acrylic lens • Heavy-duty ground
 • Meets PC function only when mounted at a 45° angle

- 45032** Red
- 45033** Yellow

Material: DURAMOLD®, Steel / Acrylic
 FMVSS: Red and Yellow - P2, PC
 Finish: Red / Yellow / Black
 Bulb: 67, 4 CP Volts / Amps: 12V / .59A
 Lens: Red 90302, Yellow 90303, Auxiliary - Clear 90301, Blue 90305

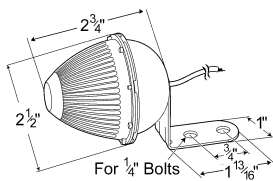

BEEHIVE LAMP WITH FIXED-ANGLE MOUNTING BRACKET

Wide light diffusion; optic design • Fade-resistant, snap-on acrylic lens
 • Bracket is permanently attached • Meets PC function only when mounted at a 45° angle

- 45022** Red
- 45022-5** Red, Retail Pack
- 45023** Yellow
- 45023-5** Yellow, Retail Pack

AUXILIARY:
45025-5 Blue, Retail Pack

Material: DURAMOLD®, Steel / Acrylic
 FMVSS: Red and Yellow - P2, PC
 Finish: Red / Yellow / Blue / Black
 Bulb: 67, 4 CP Volts / Amps: 12V / .59A
 Lens: Red 90302, Yellow 90303, Auxiliary - Clear 90301, Blue 90305

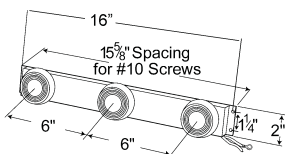

SUPERNOVA® LOW-PROFILE LED BAR LAMP

Twist-in, locking feature • Sealed UBS harness

- 49162** Red

Material: Steel / Polycarbonate
 FMVSS: P2
 Finish: Red / Black
 Volts / Amps: 12V / .18A
 Accessory: Lamp: Red 47122 Harness: 67740
 Bracket: 49140

Clearance / Marker Lamps

Feux de Gabarit / Position Lámparas de Gálibo / Demarcadora

LOW-PROFILE BAR LAMP

Uses 2 1/2" round, replaceable lamps • Twist-in, locking feature • Sealed UBS harness

49142 Red

Material: Steel / Polycarbonate
FMVSS: P2
Finish: Red / Black
Bulb: (3) 2 CP
Volts / Amps: 12V / .99A
Accessory: Harness: 67740 Lamp: Red 45812
Bracket: 49140

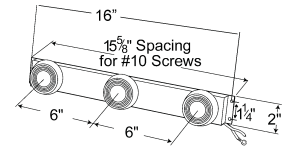

LOW-PROFILE BAR LAMP

Easy installation • Three-bulb replaceable, 45412 clearance / marker lamps • 14 1/2" aluminum bar

49042 Red

Material: Aluminum / DURAMOLD® / Acrylic
FMVSS: P2
Finish: Red / Aluminum
Bulb: (3) 193, 2 CP Volts / Amps: 12V / .99A
Lens: Red 90162

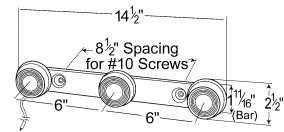

BEEHIVE-TYPE BAR LAMP

Three-bulb, replaceable 45022 lamps • Black enamel metal bar • Heat-sealed, splice-on pigtail

49002 Red

Material: Steel / DURAMOLD® / Acrylic
FMVSS: P2
Finish: Red / Black
Bulb: (3) 67, 4 CP Volts / Amps: 12V / 1.77A
Lens: Red 90302

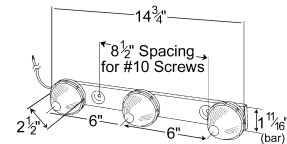

SUPERNOVA® LED BAR LAMP

Sealed flow-through UBS harness • Rugged reinforced polycarbonate bar • Easy to install

49182 Red

Material: Polycarbonate
FMVSS: P2
Finish: Red / Black
Volts / Amps: 12V / .18A
Accessory: Lamp: Red 47082



BAR LAMP

Three replaceable snap-on lamps • Sealed flow-through harness • Rugged reinforced polycarbonate bar • Easy to install

49172 Red
49173 Yellow

Material: Polycarbonate
FMVSS: P2
Finish: Red / Black
Bulb: (3) 2 CP Volts / Amps: 12V / .99A
Accessory: Lamp: Red 46412, Yellow 46413 Harness: 69710

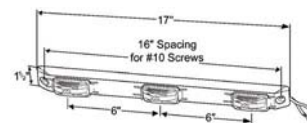

Clearance / Marker Lamps

Feux de Gabarit / Position L mparas de G libo / Demarcadora

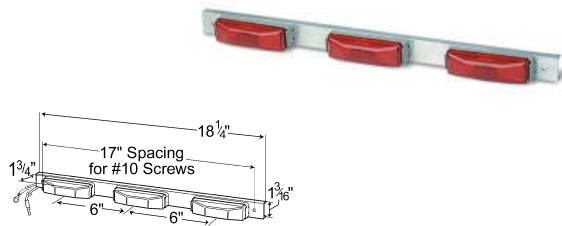

BAR LAMP

Thin-line design fits narrow rails and channels • Three two-bulb replaceable snap-on lamps • Easy installation • UBS wire harness included

49132 Red

Material: Aluminum / Polycarbonate
 FMVSS: P2
 Finish: Red / Aluminum
 Bulb: (6) 2 CP Volts / Amps: 12V / 1.98A
 Accessory: Lamp: Red 46742

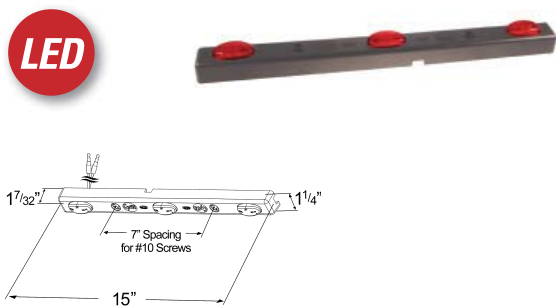

LED

MICRONOVA® CLEARANCE / MARKER LED BAR LAMP

Replaceable sealed lamps • Low-profile design fits narrow-rail applications • Encapsulant potting lamps for total circuit-board protection against vibration and corrosion • Sealed harness • Easy to install • Rugged reinforced polycarbonate bar

49202 Red, Black
49292 Red, Gray
49203 Yellow, Black

Material: Polycarbonate
 FMVSS: P2
 Finish: Red / Yellow / Black
 Volts / Amps: 12V / .45A
 Accessory: Lamps: Red 47962, Yellow 47963
 Lens: Red 47962, Yellow 47963

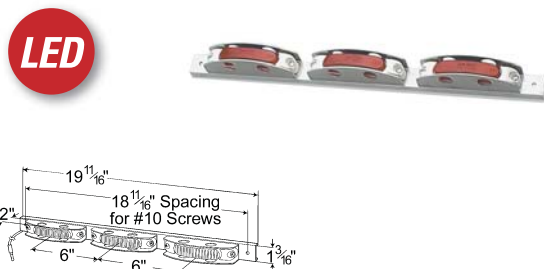

LED

SUPERNOVA® THIN-LINE LED BAR LAMP

Thin-line design fits narrow rails and channels • Easy installation • Sealed UBS Harness included • Replaceable external guard made of formed aluminum

49122 Red

Material: Aluminum / Polycarbonate
 FMVSS: P2
 Finish: Red / Aluminum
 Volts / Amps: 12V / .18A
 Accessory: Lamp: Red 46902
 Branch Guard: 43074

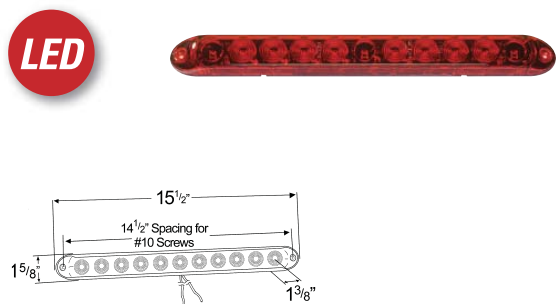

LED

15" THIN-LINE LED BAR LAMP

Rated to 100,000 hours of service life • Sealed marker lamps are shock- and vibration-proof • Impact-resistant housing is sealed for moisture protection • 3 LEDs

49192 Red
49223 Yellow

Material: Polycarbonate
 FMVSS: P2, P3
 Finish: Red / Yellow
 Volts / Amps: 12V / .25A

Clearance / Marker Lamps

Feux de Gabarit / Position Lámparas de Gálibo / Demarcadora

37

CLEARANCE / MARKER LAMPS

HYLITE ID LED BAR LAMP

Rated to 100,000 hours of service • Impact-resistant, sealed housing is shock- and vibration-resistant • For use with trailers more than 80" in overall width • 3 LEDs

49242-5 Red, Retail Pack

Material: Polycarbonate
FMVSS: P2, P3
Finish: Red
Volts / Amps: 12V / .15A



LED

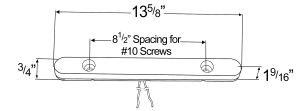

THIN-LINE BAR LAMP

Three-bulb, replaceable 45252 lamps • Black powder-coated, formed steel bar

49062 Red

Material: Steel, DURAMOLD® / Acrylic
FMVSS: P2
Finish: Red / Black
Bulb: (3) 193, 2 CP
Volts / Amps: 12V / .99A
Lens: Red 90152

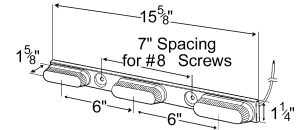

ECONOMY BAR LAMP

Three-bulb, replaceable 46882 lamps • Formed steel bar with white enamel

49112 Red
49112-5 Red, Retail Pack

Material: Steel, DURAMOLD® / Acrylic
FMVSS: P2
Finish: Red / White
Bulb: (3) 194, 2 CP
Volts / Amps: 12V / .81A
Lens: Red 92432

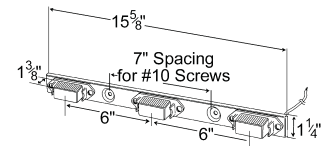

2 1/2" OVAL BAR LAMP

Impact-resistant housing with sonic sealed, shock and vibration proof lamps • Uses three dual-diode LED lamps

49212-5 Red, Retail Pack
49232-5 Red, Clear Lens, Retail Pack

Material: ABS
FMVSS: P2
Finish: Red / Black
Volts / Amps: 12V / .15A
Accessory: Lamp: Red 47012



LED

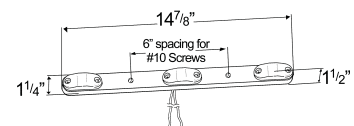

grote.com

37

Clearance / Marker Lamps

Feux de Gabarit / Position Lámparas de Gálíbo / Demarcadora

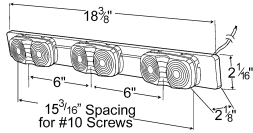

LOW-PROFILE DURAMOLD® BAR LAMPS

Three-bulb, replaceable 45262 or 46792 lamps • Black DURAMOLD® bar

OVAL STYLE:

49072 Red
49073 Yellow

SQUARE CORNER STYLE:

49082 Red

Material: DURAMOLD® / Acrylic
FMVSS: P2
Finish: Red / Yellow / Black
Bulb: (6) 1893, 2 CP Volts / Amps: 12V / 1.98A
Lens: Oval – Red 90122, Yellow 90123; Square – Red 91962

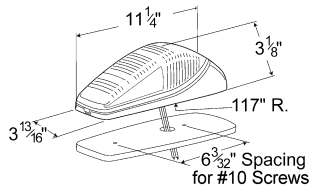

OEM-STYLE, LARGE, AERODYNAMIC CAB MARKER LAMP

3/8"-thick mounting gasket • Mounting holes interchange with most popular torpedo-type cab marker lamps • Chrome-plated body, long-life bulb • Used on Ford®, Navistar®, and Freightliner® trucks • Meets sidemarker and front clearance requirements simultaneously

46823 Yellow

Material: ABS / Polycarbonate
FMVSS: P2, P3, PC, PC2
Finish: Yellow / Chrome
Bulb: 904, 4 CP Volts / Amps: 12V / .69A
Lens: Yellow 92193

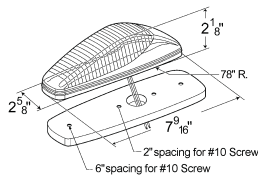

SUPERNOVA® SMALL, AERODYNAMIC CAB MARKER LED LAMP

Replaceable Lens • Same mounting and lens as incandescent (46813) • Encapsulant potting for total circuit-board protection • Meets sidemarker and front clearance requirements simultaneously

47183 Yellow

Material: DURAMOLD® / Polycarbonate
FMVSS: P2
Finish: Yellow / Black
Volts / Amps: 12V / .12A
Lens: Yellow 92183

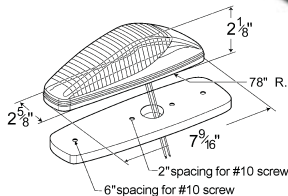

SMALL AERODYNAMIC CAB MARKER LAMP

Easy snap-on lens • Optics illuminate full lens • Used on Mack®, Navistar®, Freightliner®, Ford®, and Peterbilt® trucks • Meets sidemarker and front clearance requirements simultaneously

WITHOUT CHROME BEZEL:

46813 Yellow

WITH CHROME BEZEL:

46433 Yellow

Material: DURAMOLD® / Polycarbonate
FMVSS: P2, P3, PC, PC2
Finish: Yellow / Black
Bulb: 168, 3 CP Volts / Amps: 12V / .35A
Accessory: Chrome Bezel: 92583
Lens: Yellow 92183

SUPERNOVA® FLUSH-MOUNT CAB MARKER LED LAMP

Hermetic lens-to-housing seal • Encapsulant potting for total circuit-board protection • Sealed hard-wire terminations with UBS molded .180 bullet terminals • Freightliner®, Sterling®, and Navistar® replacement

47063 Yellow

Material: Polycarbonate
FMVSS: P2
Finish: Yellow
Volts / Amps: 12V / .12A

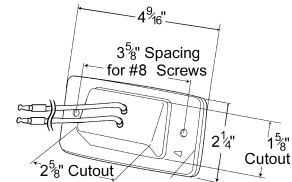
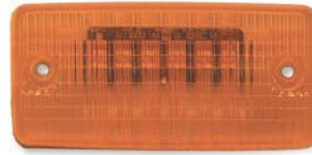

FLUSH-MOUNT CAB MARKER LAMP

Application for visors • Lens is sealed hermetically to base • Used on Freightliner®

46913 Yellow

Material: Polycarbonate
FMVSS: P2
Finish: Yellow
Pigtail: 68380

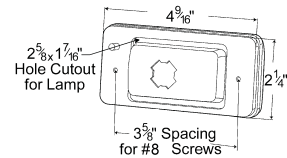

DELUXE DIE-CAST CAB MARKER LAMP

Easy installation • Neoprene mounting pad • Chrome-plated • Meets sidemarker and front clearance requirements simultaneously

45333 Yellow

Material: Zinc Die-cast / Acrylic
FMVSS: P2, P3
Finish: Yellow / Chrome
Bulb: 67, 4 CP
Volts / Amps: 12V / .59A
Pigtail: 68080
Lens: Yellow 90133

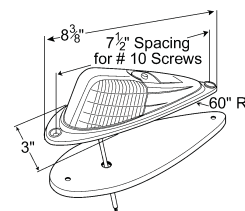

Clearance / Marker Lamps

Feux de Gabarit / Position Lámparas de Gálíbo / Demarcadora

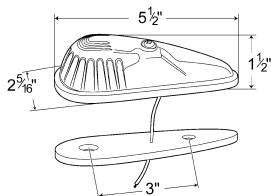

ECONOMY CAB MARKER LAMP

Fits flat or slight-contour surfaces • Replaces original equipment on Ford* trucks • Meets sidemarker and front clearance requirements simultaneously

46543 Yellow
46543-5 Yellow, Retail Pack

Material: DURAMOLD® / Acrylic
FMVSS: P2, PC
Finish: Yellow / Gray
Bulb: 67, 4 CP Volts / Amps: 12V / .59A
Pigtail: 68170
Lens: Yellow 91683

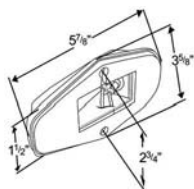

FORD* LIGHT-DUTY CAB MARKER LAMP

Replaces surface-mount, cab marker on Ford* F Series trucks • Hermetic lens-to-housing seal • Replaceable bulb design • Mounting pad and screws included

45503 Yellow

Material: Polycarbonate / ABS
FMVSS: P2, PC
Finish: Yellow / Gray
Bulb: 194, 2 CP 12V / .27A

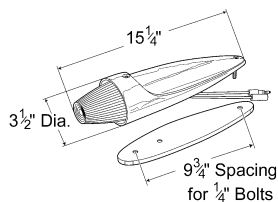

SHOCK-RESISTANT TORPEDO-STYLE CAB MARKER LAMP

Replacement for Mack* and Kenworth* • Includes two 1/4" bolts on 9 3/4" centers for mounting

45993 Yellow

Material: ABS / Acrylic
FMVSS: P2, PC
Finish: Yellow / Chrome
Bulb: 67, 4 CP Volts / Amps: 12V / .59A
Lens: Yellow 92773

LED

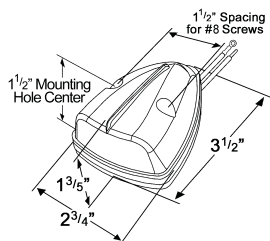

HI COUNT® SCHOOL BUS WEDGE LED MARKER LAMP

Hermetically sealed construction • Potted circuit board • Mounting gasket included • Blunt-cut, hardwire termination • Meets PC when mounted at a 45° only

G5052 Red
G5052-5 Red, Retail Pack **new**
G5053 Yellow
G5053-5 Yellow, Retail Pack

Material: Polycarbonate
FMVSS: P2, PC
Finish: Red / Yellow
Volts / Amps: 12V / .1A

Clearance / Marker Lamps

Feux de Gabarit / Position Lámparas de Gálibo / Demarcadora

41

CLEARANCE / MARKER LAMPS

SCHOOL BUS WEDGE MARKER LAMP

Adaptable front / side / rear mount • Galvanized steel housing • Fits most school bus applications

46322 Red
46323 Yellow

Material: Galvanized Steel / Acrylic
FMVSS: P2
Finish: Red / Yellow
Bulb: 168, 3 CP Volts / Amps: 12V / .35A
Lens: Red 99912, Yellow 99913

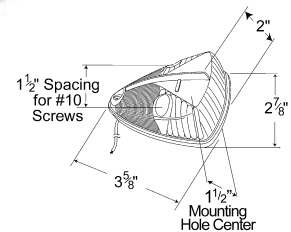

SCHOOL BUS RECTANGULAR MARKER LAMP

OEM-style • Fits most school bus applications • Includes mounting pad

46332 Red
46333 Yellow

Material: Zinc / Acrylic
FMVSS: P2
Finish: Red / Yellow
Bulb: 168, 3 CP Volts / Amps: 12V / .35A
Accessory: Mounting Pad: 97920
Lens: Red 99802, Yellow 99803

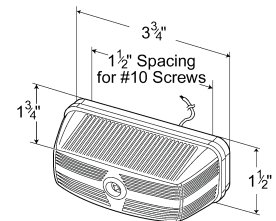

LOW-PROFILE AERODYNAMIC CAB MARKER LAMP

Aerodynamic design • Cab marker replacement for heavy-duty Ford® trucks • Field-replaceable lens • Mounting screws included

46002 Red
46003 Yellow

Material: Polycarbonate
FMVSS: P2
Finish: Red / Yellow / Black
Bulb: 168, 3 C.P Volts / Amps: 12V / .27A
Lens: Yellow 93393
Replacement Pigtail: 68400

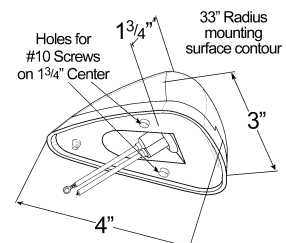

grote.com

41

Stop / Tail / Turn Lamps

Feux Arrêt / Arrière / Direction Lámparas de Freno / Cuarto / Direccional

LED



53252



53303

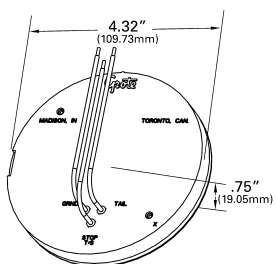
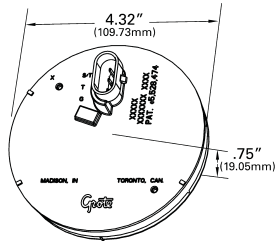
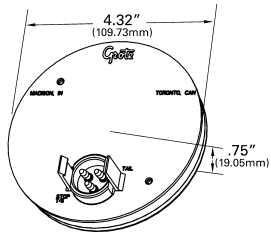

SUPERNOVA® 4" 10-DIODE PATTERN, STOP / TAIL / TURN LED LAMP

Lens design spreads light for maximum dispersion • Encapsulant potting for total circuit-board protection • Hermetic lens-to-housing seal • Advanced pin connection system uses tin-plated, solid-brass pin terminals • Uses same UBS pigtail as male-pin incandescent

MALE-PIN STOP / TAIL / TURN:

53252	Red, Grommet Mount
53272	Red w / Gray Theft-Resistant Flange
53282	Red w / White Theft-Resistant Flange
53292	Red w / Black Theft-Resistant Flange
53302	Red w / Stainless-Steel Theft-Resistant Flange
52092	Red, Grommet Mount 24-Volt

MALE-PIN STOP / TAIL / TURN KITS:

53452	Red (53252 + 91740 + 66830)
53462	Red (53252 + 91740 + 67002)
53432	Red (53302 + 67002)
53342	Red (53252 + 66830)
53442	Red (53302 + 66830)

HARD-SHELL CONNECTER STOP / TAIL / TURN:

53552	Red, Grommet Mount
54022	Red w / Black Snap-In Flange
54032	Red w / Gray Snap-In Flange
54042	Red w / Stainless-Steel Snap-In Flange

HARD-SHELL CONNECTER STOP / TAIL / TURN KITS:

54102	Red (53552 + 92512) new
--------------	--------------------------------

HARD-WIRED STOP / TAIL / TURN:

53532	Red, Grommet Mount
--------------	--------------------

MALE-PIN AUXILIARY:

53253	Yellow, Grommet Mount
53273	Yellow w / Gray Theft-Resistant Flange
53293	Yellow w / Black Theft-Resistant Flange
53303	Yellow w / Stainless-Steel Theft-Resistant Flange
52093	Yellow, Grommet Mount 24-Volt new

HARD-SHELL CONNECTER AUXILIARY:

53553	Yellow, Grommet Mount
54023	Yellow w / Black Snap-In Flange
54033	Yellow w / Gray Snap-In Flange

Material: Acrylic / ABS / Polycarbonate
FMVSS: S / T / T - I, P2, S, T; Auxiliary - P2
Finish: Red / Yellow

Volts / Amps: Red - 12V / .24A (I,S) / .03A (T)

Volts / Amps: Yellow - 12V / .15A (P2)

Volts / Amps: Red - 24V / .24A (I,S) / .03A (T)

Volts / Amps: Yellow - 24V / .12A (P2)

Accessory: Reflective Flange: Red 43702

Bracket: 93552, 43253, 92510, 92512, 92513, 43572, 43642, 43655, 43732, 93190, 93550, 93553, 93683

Grommet: 91740, 91950

Pigtail: 66815, 66841, 67002, 66842, 67013, 66816, 66845, 67005, 66823, 66830, 67016, 66846, 66836, 67006, 66861, 66862

Stop / Tail / Turn Lamps

Feux Arrêt / Arrière / Direction Lámparas de Freno / Cuarto / Direccional

SUPERNOVA® 4" FULL-PATTERN STOP / TAIL / TURN LED LAMP

Encapsulant potting for total circuit-board protection • Hermetic lens-to-housing seal • Advanced pin connection system uses tin-plated, solid-brass pin terminations • Uses same UBS pigtail as male-pin incandescent

STOP / TAIL / TURN:

- 53312** Red, Grommet Mount
- 53322** Red w / White Theft-Resistant Flange
- 53542** Red w / Gray Theft-Resistant Flange
- 53182** Red w / Black Theft-Resistant Flange
- 53192** Red w / Stainless-Steel Theft-Resistant Flange
- 52162** Red, Grommet Mount 24-Volt

3 PIN, REAR TURN:

- 53413** Yellow, Grommet Mount
- 53523** Yellow w / Stainless-Steel Theft-Resistant Flange
- 52163** Yellow, Grommet Mount 24-Volt

FRONT PARK/TURN:

- 53313** Yellow, Grommet Mount
- 53193** Yellow w / Stainless-Steel Theft-Resistant Flange

2 PIN, REAR TURN:

- 55103** Yellow, Grommet Mount
- 55153** Yellow, 24 Volt

Material: Acrylic / ABS
 FMVSS: S / T / T - I, P2, S, T; Rear Turn - I; Front P / T - I, P
 Finish: Red / Yellow
 Volts / Amps: Red - 12V / .48A (I,S) / .04A (P2,T)
 Volts / Amps: Rear Turn - 12V / .71A (I) / .14A (P2)
 Volts / Amps: Front P / T - 12V / 1.06A (I) / .13A (P,P2)
 Volts / Amps: Red - 24V / .2A (I,S) / .02A (P2,T)
 Volts / Amps: Yellow - 24V / .34A (I) / .06A (P2)
 Bracket: 93552, 43253, 92510, 92512, 92513, 43572, 43642, 43655, 43732, 93190,
 93550, 93553, 93683 Grommet: 91740, 91950
 Pigtail: 66815, 66841, 67002, 66842, 67013, 66816, 66845, 67005, 66823, 66830,
 67016, 66846, 66836, 67006, 66861, 66862



53312

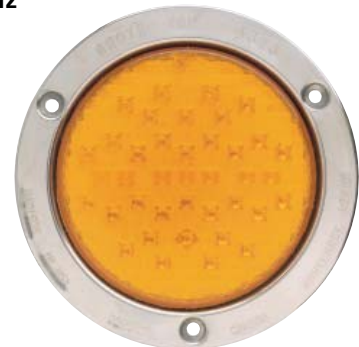

53523

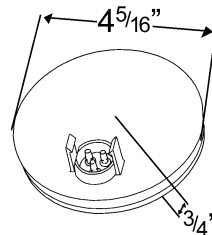

SUPERNOVA® 4" NEXGEN™ LED STOP / TAIL / TURN

Uses existing pigtails and wiring for cost-effective retrofit • 20% less current draw than major competitor LED products • Fully encapsulated circuitry provides protection from the elements • Similar look to incandescent light, which helps prevent theft

MALE-PIN STOP / TAIL / TURN

- 54332** Red, Grommet Mount new
- 54462** Red, White Flange new
- 54472** Red, Gray Flange new
- 54482** Red, Black Flange new
- 54492** Red, Stainless-Steel Flange new

HARD-SHELL STOP / TAIL / TURN

- 54362** Red, Grommet Mount new

MALE-PIN AUXILIARY

- 54333** Yellow new
- 54463** Yellow, White Flange new
- 54473** Yellow, Gray Flange new
- 54483** Yellow, Black Flange new
- 54493** Yellow, Stainless-Steel Flange new

HARD-SHELL AUXILIARY

- 54363** Yellow, Grommet Mount new

Material: Acrylic / ABS
 FMVSS: S / T / T - I, P2, S, T; Auxiliary- P2
 Finish: Red / Yellow
 Volts / Amps: 12V / .24A (I,S) / .03A (T)
 Bracket: 93552, 43253, 92510, 92511, 92512, 92513, 43572, 43642, 43655, 43732,
 93190, 93550, 93683, 51090 Grommet: 91740, 91950
 Pigtail: 66815, 66841, 67002, 66842, 67013, 66816, 66845, 67005, 66823, 66830,
 67016, 66846, 66836, 67006, 66861, 66862

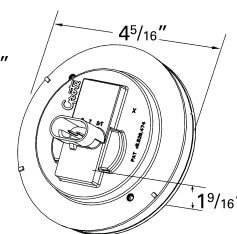
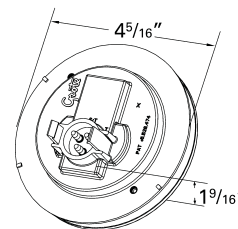

Stop / Tail / Turn Lamps

Feux Arrêt / Arrière / Direction Lámparas de Freno / Cuarto / Direccional

LED

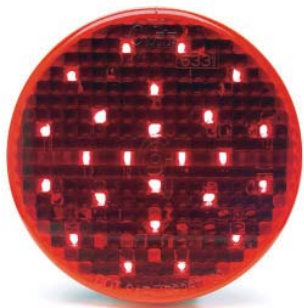

G4002

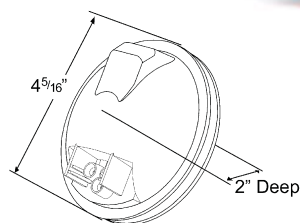

4" HI COUNT® STOP /TAIL /TURN LED LAMP

Female-pin termination accepts all popular plug-in connectors • Concentric, high-count diode design • Fits all popular mountings and grommets

STOP / TAIL / TURN:

- G4002** Red
- G4002-5** Red, Retail Pack
- G4022** Red, Clear Lens **new**
- G4023** Yellow, Clear Lens **new**

STOP / TAIL / TURN KIT:

- G4012** Red (G4002 + 91740 + 67090)
- G4012-5** Red (G4002 + 91740 + 67090) Retail Pack

AUXILIARY:

- G4003** Yellow
- G4003-5** Yellow, Retail Pack
- G4023** Yellow, Clear Lens **new**

Material: Polycarbonate / Acrylic
 FMVSS: Red – I, P2, S, T; Yellow – I
 Finish: Red / Yellow
 Volts / Amps: Red – 12V / .48A (I,S) / .04A (P2,T)
 Volts / Amps: Yellow – 12V / .71A (I)
 Bracket: 43572, 43253, 92510, 92512, 92513, 43732, 43642, 43655
 Grommet: 91740, 91950
 Pigtails: 67000, 67090, 66811, 66812, 66843, 66844, 66825

LED

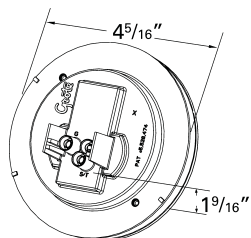

GROTE SELECT® 4" LED STOP /TAIL /TURN

Longer life than incandescent lamps • Faster light-on response time for safety • Provides greater stopping alert distance than incandescent lamps • Less current draw than standard incandescent lamps increases fuel efficiency, leaves more voltage available to other vehicle systems • Uses existing pigtailed and wiring for cost-effective retrofit • Resemblance to incandescent light alleviates theft concerns • Hermetic lens-to-housing seal prevents moisture intrusion

- 54342** Red, Female-Pin **new**
- 54343** Yellow, Female-Pin **new**

Material: ABS / Acrylic
 FMVSS: S / T / T-I, P2, S, T; Auxiliary- P2
 Finish: Red / Yellow
 Volts / Amps: 12V / .24A (I,S) / .03A (T)
 Bracket: 93552, 43253, 92510, 92511, 92512, 92513, 43572, 43642, 43655, 43732, 93190, 93550, 93553, 93683, 51090
 Grommet: 91740, 91950
 Pigtails: 66812, 66843, 66844, 66812, 66825, 67000, 67090



4" BLUE-CHIPTORSION MOUNT® II PREMIUM STOP /TAIL /TURN LAMP

Torsion Mount® II, Gel-Mount® bulb cradle design • Direct interchange with Truck-Lite® Super 40® • Uses 50% more cushioning gel than standard lamps • Bulb track and terminals for added corrosion protection • Female-pin termination accepts all popular connections • Clear chip coating provides UV protection on lens

- 52952** Red

Material: Polycarbonate
 FMVSS: I, P2, S, T
 Finish: Red
 Bulb: 32 / 3 CP Volts / Amps: Red – 12V / 2.1A (I,S) / .59A (P2,T)
 Bracket: 43572, 43252, 92510, 92512, 92513
 Grommet: 91740, 91950
 Pigtails: 67000, 66811, 66812, 66843, 66844, 66825

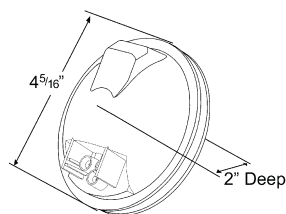

Stop / Tail / Turn Lamps

Feux Arrêt / Arrière / Direction Lámparas de Freno / Cuarto / Direccional

4" TORSION MOUNT® II MALE-PIN STOP /TAIL /TURN LAMP

Torsion Mount® II Gel-Mount® bulb cradle design • Heavy-duty bulb provides greater reliability • O-ring seal and male-pin design reduce corrosion • Locking tabs ensure solid pigtail connection • 53100 lamp has clear back for interior illumination

STOP / TAIL / TURN:

- 53100** Red, Clear Housing
- 53102** Red

STOP / TAIL / TURN KIT:

- 53112** Red (53102 + 91740 + 67002)

FRONT PARK / TURN:

- 53103** Yellow

Material: Polycarbonate
 FMVSS: Red – I, P2, S, T; Yellow – I, P; 53100 - I, S, T
 Finish: Red / Yellow
 Bulb: 32 / 2 CP Volts / Amps: Red - 12V / 2.1A (I,S) / .48A (P2,T)
 Volts / Amps: Yellow – 12V / 2.1A (I) / .48A (P)
 Bracket: 43572, 43253, 92510, 92512, 92513, 43642, 43655
 Grommet: 91740, 91950 Pigtail: 67002, 66841, 66815, 66842, 67013, 66816, 66845, 67005, 66823, 67016, 66846

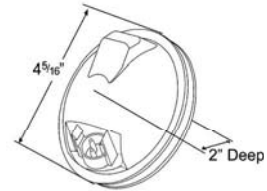

4" TORSION MOUNT® II MALE-PIN TURN LAMP

Torsion Mount® II Gel-Mount® bulb cradle design • Heavy-duty bulb provides greater reliability • Locking tabs ensure solid pigtail connection • O-ring seal and male-pin design reduce corrosion

- 55712** Red
- 55713** Yellow

Material: Polycarbonate
 FMVSS: I, S
 Finish: Red / Yellow
 Bulb: 32 CP Volts / Amps: 12V / 2.1A
 Bracket: 43572, 43253, 92510, 92512, 92513
 Grommet: 91740, 91950 Pigtail: 67013, 66842, 67016, 66846

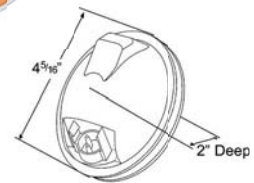

4" TORSION MOUNT® II STOP /TAIL / TURN LAMP

Torsion Mount® II Gel-Mount® bulb cradle design • Heavy-duty bulb provides greater reliability • Female receptacle accepts all popular plug-in connectors

STOP / TAIL / TURN:

- 52770** Red, Clear Housing
- 52772** Red
- 52772-5** Red, Retail Pack
- 52152** Red, 24-Volt

STOP / TAIL / TURN KIT:

- 52782** Red (52772 + 91740 + 67000)

FRONT PARK / TURN:

- 52773** Yellow
- 52153** Yellow, 24-Volt

FRONT PARK / TURN KIT:

- 52783** Yellow (52773 + 91740 + 67000)

Material: Polycarbonate
 FMVSS: Red – I, P2, S, T; Yellow – I, P; 52770 - I, S, T
 Finish: Red / Yellow
 Bulb: 32 / 2 CP Volts / Amps: 12V / 2.1A (I,S) / .48A (P2,T)
 Bulb: 32 / 2 CP Volts / Amps: 24V / 1.05A
 Bracket: 43572, 43253, 92510, 92512, 92513
 Grommet: 91740, 91950 Pigtail: 67000, 66811, 66812, 66843, 66844, 66825

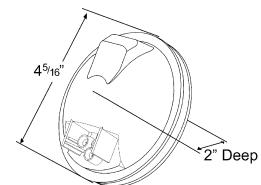

Stop / Tail / Turn Lamps

Feux Arrêt / Arrière / Direction Lámparas de Freno / Cuarto / Direccional

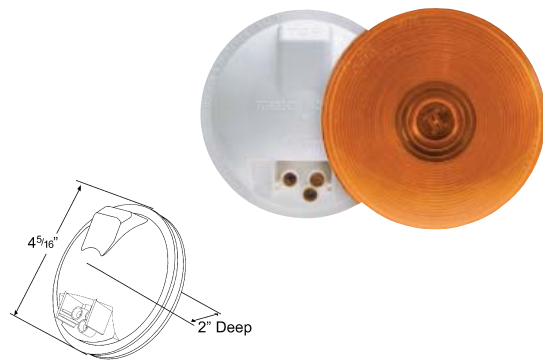

4" TORSION MOUNT® II TURN LAMP

Torsion Mount® II Gel-Mount® bulb cradle design • Heavy-duty bulb provides greater reliability • Single contact

55572 Red
55573 Yellow

Material: Polycarbonate
FMVSS: Red - I, S; Yellow - I
Finish: Red / Yellow
Bulb: 32 CP
Volts / Amps: 12V / 2.1A (I,S)
Bracket: 43572, 43253, 92510, 92512, 92513
Grommet: 91740, 91950
Pigtail: 67011, 67010, 67014, 67020

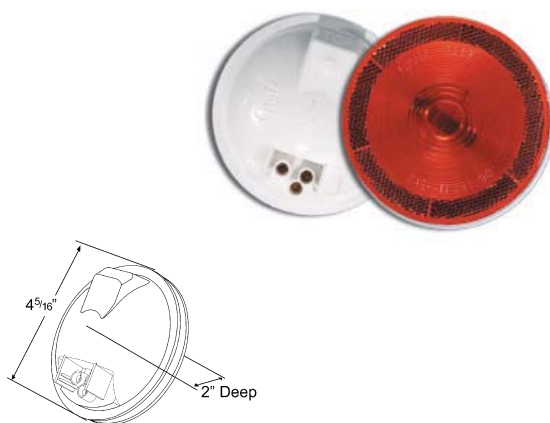

4" TORSION MOUNT® II STOP /TAIL /TURN LAMP WITH BUILT-IN REFLECTOR

For use on vehicles less than 80" wide • Torsion Mount® II Gel-Mount® bulb cradle design • Heavy-duty bulb provides greater reliability • Female receptacle accepts all popular plug-in connectors

52672 Red

KITS:

52682 Red (52672 + 91740 + 67000)

Material: Polycarbonate
FMVSS: A, I, P2, S, T
Finish: Red / Yellow
Bulb: 32 / 2 CP
Volts / Amps: 12V / 2.1A (I,S) / .48A (P2,T)
Bracket: 43572, 43253, 43642, 43655, 92510
Grommet: 91740, 91950
Pigtail: 66811, 66812, 67000, 66825, 66843, 66844

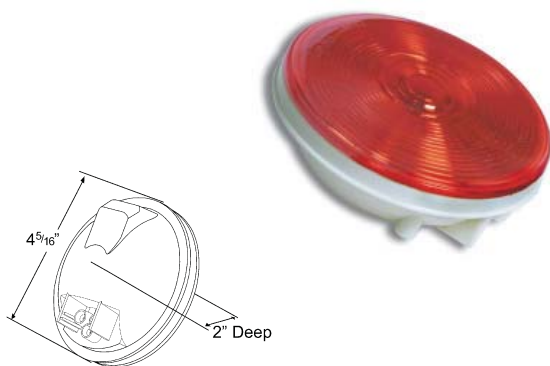

4" ECONOMY STOP /TAIL /TURN LAMP

Standard female connection • 4" diameter lamp • Fits all competitive pigtails, brackets and grommets • Hermetic lens-to-housing seal

STOP / TAIL / TURN:

52922 Red
52922-5 Red, Retail Pack
52692 Red w / White, Theft-Resistant Flange
53612 Red w / Gray, Theft-Resistant Flange

STOP / TAIL / TURN KIT:

53012 Red (52922 + 91740 + 67090)
53012-5 Red (52922 + 91740 + 67090), Retail Pack

FRONT PARK / TURN:

52923 Yellow

FRONT PARK / TURN KIT:

53013-5 Yellow (52923 + 91740 + 67090), Retail Pack

Material: Polycarbonate
FMVSS: Red - I, P2, S, T; Yellow - I, P
Finish: Red / Yellow
Bulb: 32 / 2 CP
Volts / Amps: 12V / 2.1A (I,S) / .48A (T,P,P2)
Bracket: 43572, 43253, 92510, 92512, 92513
Grommet: 91740, 91950
Pigtail: 67000, 67011, 67010, 67014, 67020, 66811, 66812, 66843, 66825

Stop / Tail / Turn Lamps

Feux Arrêt / Arrière / Direction Lámparas de Freno / Cuarto / Direccional

POWER UNIT MODULE

Heavy-gauge steel plate and can • Torsion Mount® II, 4" round, male- or female-pin S / T / T lamps • Pre-assembled wiring harness and 5-way connector



50820 Female-Pin Lamps

Material: Steel
 FMVSS: A, I, L, R, S, T
 Finish: Black / Red
 Bulb: S / T / T - 32 / 2 CP Volts / Amps: 12V / 4.2A (I,S) / .96A (P2,T)
 Bulb: Backup - (2) 32 CP Volts / Amps: 12V / 2.1A (R)
 Bulb: License - 2 CP Volts / Amps: 12V / .66A (L)
 Accessory: Lamp: S / T / T - Male-Pin 53102, Female-Pin 52772,
 Backup - Male-Pin 62221, Female-Pin 62271 License - 60291
 Grommet: 91740

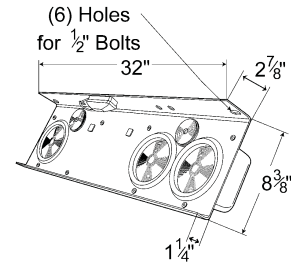

SUPERNOVA® STOP /TAIL /TURN LED LAMP POWER MODULE WITH SIDEMARKER

Heavy-gauge steel plate and can • Pre-assembled with wiring • Uses SuperNova®, 10-Diode Pattern, 4" LED lamps • Exceeds SAE J914, Nov. '87



51002 Red, RH 51012 Red, LH

Material: Steel
 FMVSS: A, I, P2, S, T
 Finish: Gray / Red
 Volts / Amps: 12V / .24A (I,S) / .06A (P2) / .03A (T)
 Accessory: Lamp: S / T / T 53252, Marker 47092
 Bracket: 43655
 Grommet: 91740

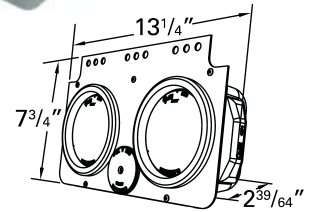

4" LAMP STOP /TAIL /TURN MODULE

Heavy-gauge steel plate and can • Torsion Mount® II, 4" round, sealed lamps • Right- or left-hand application



51052 Red

Material: Steel
 FMVSS: A, I, P2, S, T
 Finish: Gray / Red
 Bulb: 32 / 2 CP Volts / Amps: 12V / 2.1A (I, S) / .48A (P2, T)
 Accessory: Lamp: S / T / T - Red 52772
 Bracket: 43655
 Grommet: 91740

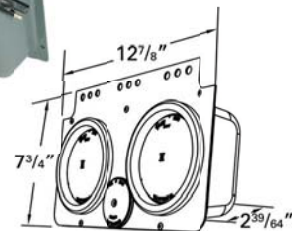

4" LAMP STOP /TAIL /TURN MODULE WITH SIDEMARKER

Heavy-gauge steel plate and can • Torsion Mount® II, 4" round, sealed lamps



51022 Red, RH 51032 Red, LH

Material: Steel
 FMVSS: A, I, P2, S, T
 Finish: Gray / Red
 Bulb: S / T / T - 32 / 2 CP Volts / Amps: 12 V - 2.1(I,S) / .48(P2,T) A
 Bulb: Sidemarker - (2) 2 CP Volts / Amps: 12 V - .54(P2) A
 Accessory: Lamps: S / T / T - 52772, Marker - 47642
 Bracket: 43655
 Grommet: 91740

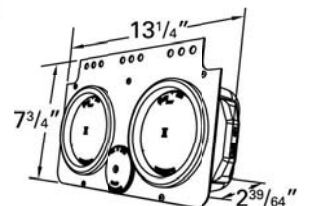

Stop / Tail / Turn Lamps

Feux Arrêt / Arrière / Direction Lámparas de Freno / Cuarto / Direccional

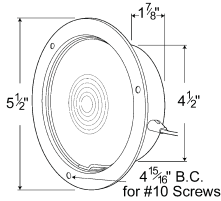

FIELD-RESEALABLE STAINLESS STEEL LAMP

Electro-polished stainless-steel body • Torsion Mount® bulb cradle design
• Polycarbonate lens

DOUBLE CONTACT:

52612 Red

Material: Stainless-Steel / Polycarbonate
FMVSS: I, P2, P3, S, T
Finish: Red / Stainless
Bulb: 1157, 32 / 3 CP Volts / Amps: 12V / 2.1A (I,S) / .59A (P2,P3,T)
Pigtail: 68130
Lens: 90762

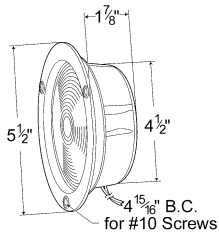

DURAMOLD® HOUSING LAMP

Snap-ring lens application • 2-wire pigtail

DOUBLE CONTACT:

50222 Red

Material: DURAMOLD® / Acrylic
FMVSS: I, P2, P3, S, T
Finish: Red / Black
Bulb: 1157, 32 / 3 CP Volts / Amps: 12V / 2.1A (I,S) / .59A (P2,P3,T)
Accessory: Snap Ring 99593
Pigtail: 68130
Lens: Red 90012

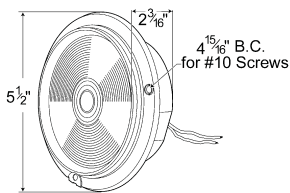

RUBBER HOUSING LAMP

Lens held in by rubber flange • Standard exterior wiring • Brass eyelets in two mounting holes

DOUBLE CONTACT:

50502 Red

Material: Rubber / Acrylic
FMVSS: I, P2, P3, S, T
Finish: Red / Black
Bulb: 1157, 32 / 3 CP Volts / Amps: 12V / 2.1A (I,S) / .59A (P2,P3,T)
Pigtail: 68150
Lens: Red 90012

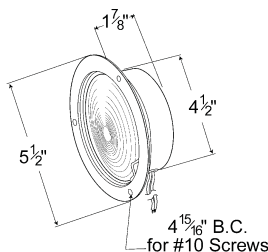

ECONOMY STAINLESS-STEEL LAMP

Easy snap-on lens • Rugged stainless-steel construction

DOUBLE CONTACT:

52522 Red

Material: Stainless-Steel / Polycarbonate
FMVSS: I, P2, P3, S, T
Finish: Red / Stainless
Bulb: 1157, 32 / 3 CP Volts / Amps: 12V / 2.1A (I,S) / .59A (P2,P3,T)
Pigtail: 68150
Lens: Red 90762

Stop / Tail / Turn Lamps

Feux Arrêt / Arrière / Direction Lámparas de Freno / Cuarto / Direccional

ECONOMY STEEL LAMP

Rugged steel construction • Easy snap-on lens

DOUBLE CONTACT:

- 50232** Red
- 50232-5** Red, Retail Pack

SINGLE CONTACT:

- 55092** Red

Material: Steel / Acrylic
 FMVSS: Double - I, P2, P3, S, T; Single - I, S
 Finish: Red / Black
 Bulb: 1156, 32 CP Volts / Amps: 12V / 2.1A (I,S) / .59A (T)
 Bulb: 1157, 32 / 3 CP Volts / Amps: 12V / 2.1A (I,S) / .59A (P2,P3,T)
 Pigtail: 68130, 68150
 Lens: Red 90012
 Accessory: Snap Ring 99595

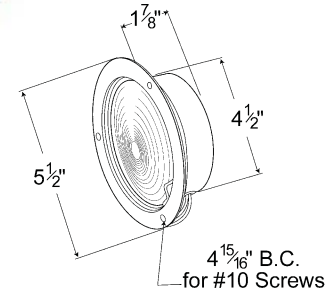

SUPERNOVA® LED OVAL STOP / TAIL / TURN LAMP

Advanced pin connection system uses tin-plated, solid-brass terminals

- Encapsulant potting covers LED circuit board
- Male-pin termination for premium seal ability
- Meets specifications for vertical and horizontal mounting



STOP / TAIL / TURN:

- 53962** Red, Grommet Mount
- 53592** Red w / Gray Theft-Resistant Flange
- 53622** Red w / Black Theft-Resistant Flange
- 53972** Red w / Stainless-Steel Theft-Resistant Flange
- 52072** Red, 24-Volt

STOP / TAIL / TURN KIT:

- 53122** Red (53962 + 92420 + 67005)

AUXILIARY:

- 53963** Yellow, Grommet Mount
- 53593** Yellow w / Gray Theft-Resistant Flange
- 53623** Yellow w / Black Theft-Resistant Flange
- 53973** Yellow w / Stainless-Steel Theft-Resistant Flange
- 52073** Yellow, 24-Volt

AUXILIARY KITS:

- 53123** Yellow (53963 + 92420 + 67005)

Material: ABS / Acrylic
 FMVSS: Red - I, P2, S, T; Yellow - P2
 Finish: Red / Yellow
 Volts / Amps: Red - 12V / .48A (I,S) / .06A (T)
 Volts / Amps: Yellow - 12V / .48A
 Volts / Amps: Red - 24V / .48A (I,S) / .06A (T)
 Volts / Amps: Yellow - 24V / .48A
 Bracket: 43362, 43952, 43220, 43223, 43222, 43100, 43723
 Grommet: 92420, 92720
 Pigtail: 66815, 66841, 67002, 66842, 67013, 66830, 67006, 66813, 66814, 66823, 66816, 66845, 67005

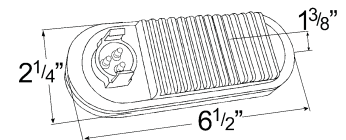

Stop / Tail / Turn Lamps

Feux Arrêt / Arrière / Direction Lámparas de Freno / Cuarto / Direccional

LED

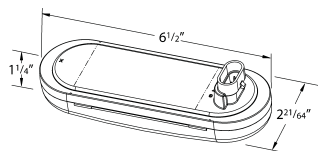
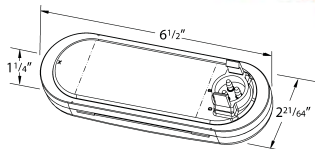

SUPERNOVA® LED 9-DIODE OVAL STOP /TAIL /TURN LAMP

High-visibility optics combined with high output LEDs result in a high-performing stop, tail and turn lamp • Available in Grote OEM male-pin, hard-shell and hard wired termination options for easy retrofit or replacement
• Electronics completely encapsulated with durable epoxy for maximum protection from the environment • Fits current mounting flanges and grommets

MALE-PIN:

- 54132** Red **new**
54133 Yellow **new**

HARD-SHELL:

- 54142** Red **new**
54143 Yellow **new**

Material: ABS / Acrylic
FMVSS: I6, P, S, T, P2
Finish: Red / Yellow
Volts / Amps: 13.5V / .02A (T) / .14A (I,S)
Accessory: Chrome Bezel 42153
Bracket: 43220, 43222, 43223, 43732, 99470, 43362, 43952, 43172, 43100, 42152, 42153
Grommet: 92420, 92720, 67151
Pigtail: 66816, 66845, 67005, 66830, 66836, 67006

LED

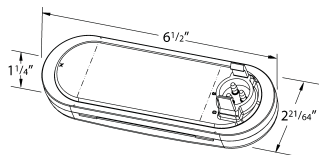

SUPERNOVA® NEXGEN™ LED OVAL STOP /TAIL /TURN LAMP

Available in Grote OEM male-pin retrofit or replacement • Electronics completely encapsulated with durable epoxy for maximum protection from the environment • Fits current mounting flanges and grommets

- 54162** Red, Male-Pin Termination **new**
54163 Yellow, Male-Pin Termination **new**

BOAT TRAILER KIT:

- 65390-5** Red, Retail Pack

Material: ABS / Acrylic
FMVSS: I6, P, S, T, P2
Finish: Red / Yellow
Volts / Amps: 13.5V / .02A (T) / .14A (I,S)
Bracket: 43220, 43222, 43223, 43723, 99470, 43362, 43952, 43172, 43100, 42152, 42153
Grommet: 92420, 92720, 67151
Pigtail: 66815, 66841, 67002, 66816, 66845, 67005, 66830, 66836, 67006

LED

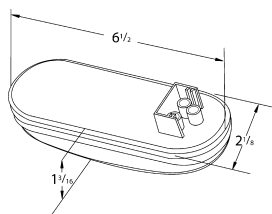

HI COUNT® OVAL STOP /TAIL /TURN LED LAMP

Female-pin terminations accept all popular plug-in connectors • Fits same connections as female incandescent lamps • Lower amp draw of LEDs allows for use of more lamps without draining vehicle power • LEDs provide greater stopping distance for trailing vehicles

- G6002** Red
G6002-5 Red, Retail Pack **new**
G6003 Yellow **new**
G6003-5 Yellow, Retail Pack **new**
G6012 Red, Clear Lens **new**
G6013 Yellow, Clear Lens **new**

Material: Polycarbonate
FMVSS: I, S, T, P, P2
Finish: Red / Yellow
Volts / Amps: 12V / .43A (I,S) / .05A (T)
Bracket: 43362, 43952, 43220, 43223, 43222, 43100, 43723
Grommet: 92720, 92420 Pigtail: 67090, 66815, 66841, 67002, 66842, 67013, 66830, 67006, 66813, 66844, 66823, 66816, 66845, 67005

Stop / Tail / Turn Lamps

Feux Arrêt / Arrière / Direction Lámparas de Freno / Cuarto / Direccional

51

STOP / TAIL / TURN LAMPS

GROTE SELECT® OVAL LED STOP / TAIL / TURN LAMP

Specially formulated encapsulent potting protects against moisture, vibration and corrosion • Fits current mounting flanges and grommets • Female-pin termination accepts all popular connections

- 54172** Red, Female Termination **new**
- 54173** Yellow, Female Termination **new**

Material: ABS / Acrylic
FMVSS: I6, P, S, T, P2
Finish: Red / Yellow
Volts / Amps: Red 12V / .48A (I,S) / .04A (P2, T)
Volts / Amps: Yellow 12V / .71A (I)
Bracket: 43220, 43222, 43223, 43723, 99470, 43362, 43952, 43172, 43100, 42152, 42153
Grommet: 92420, 92720, 67151
Pigtail: 66811, 66843, 66844, 66830, 67090



LED

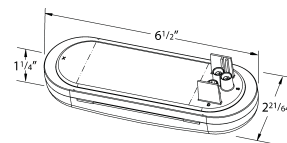

OVAL MALE-PIN TORSION MOUNT® III STOP / TAIL / TURN LAMP

Torsion Mount® III, Gel-Mount® bulb cradle design minimizes bulb vibration • Double contact • Oval style lamp fits competitors' grommets and brackets • Locking tabs ensure solid pigtail connection • O-ring seal design reduces corrosion

STOP / TAIL / TURN:

- 52562** Red

STOP / TAIL / TURN KIT:

- 52582** Red (52562 + 92420 + 67002)

FRONT PARK / TURN:

- 52563** Yellow

Material: Polycarbonate
FMVSS: Red - I, P2, S, T; Yellow - I, P
Finish: Red / Yellow
Bulb: 32 / 3 CP Volts / Amps: 12V / 2.1A (I,S) / .59A (P,P2,T)
Bracket: 43362, 43952, 43220, 43222, 43223, 43723
Grommet: 92420
Pigtail: 66815, 66841, 67002, 66816, 66845, 67005, 66830, 66823, 66836, 67006, 66813, 66814

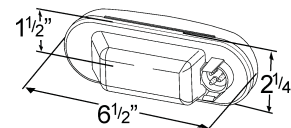

OVAL MALE-PIN TORSION MOUNT® III TURN LAMP

Torsion Mount® III, Gel-Mount® bulb cradle design minimizes bulb vibration • Oval style lamp fits competitors' grommets and brackets • Locking tabs ensure solid pigtail connection

- 55783** Yellow

Material: Polycarbonate
FMVSS: I
Finish: Yellow
Bulb: 32 CP Volts / Amps: 12V / 2.1A
Bracket: 43362, 43952, 43220, 43222, 43223
Grommet: 92420, 92720
Pigtail: 66842, 67013, 67016, 66846

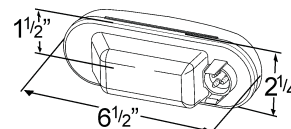

grote.com

51

Stop / Tail / Turn Lamps

Feux Arrêt / Arrière / Direction Lámparas de Freno / Cuarto / Direccional

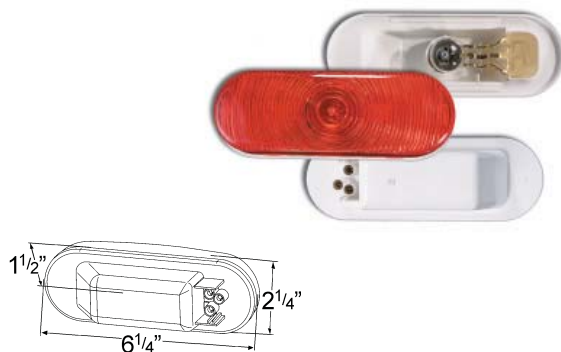

OVAL TORSION MOUNT® III STOP / TAIL / TURN LAMP

Torsion Mount® III, Gel-Mount® bulb cradle design minimizes bulb vibration
 • Double contact • Uses UBS pigtail • Oval style lamp fits competitors' grommets and brackets

STOP/TAIL / TURN:

52892 Red
52892-5 Red, Retail Pack

STOP / TAIL / TURN KIT:

52572 Red (52892 + 92420 + 67000)

FRONT PARK / TURN:

52893 Yellow
52893-5 Yellow, Retail Pack

FRONT PARK / TURN KIT:

52573 Yellow (52893 + 92420 + 67000)

Material: Polycarbonate
 FMVSS: Red – I, P2, S, T; Yellow – I, P
 Finish: Red / Yellow
 Bulb: 32 / 3 CP Volts / Amps: 12V / 2.1A (I,S) / .59A (P,P2,T)
 Bracket: 43362, 43952, 43220, 43222, 43223, 43723
 Grommet: 92420, 92720
 Pigtail: 67000, 66812, 66825, 66843, 66811, 66844

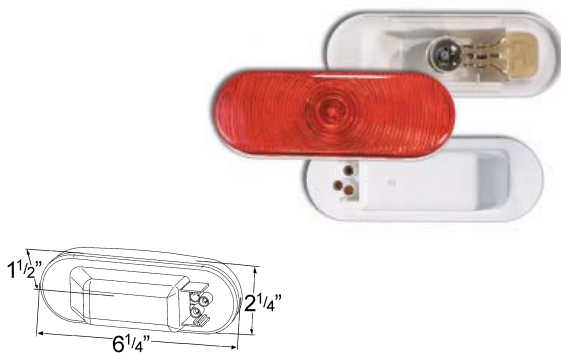

OVAL TORSION MOUNT® III TURN LAMP

Torsion Mount® III, Gel-Mount® bulb cradle design minimizes bulb vibration
 • Single contact • Oval lamp fits competitors' grommets, brackets and pigtails

55772 Red
55773 Yellow

Material: Polycarbonate
 FMVSS: I
 Finish: Red / Yellow
 Bulb: 32 CP Volts / Amps: 12V / 2.1A (I)
 Bracket: 43362, 43952, 43220, 43222, 43223, 43723
 Grommet: 92420, 92720
 Pigtail: 67011, 67010, 67011, 67014, 67020

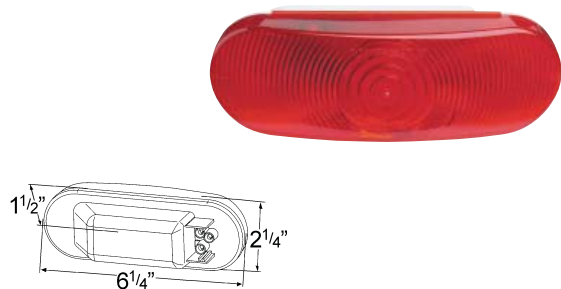

ECONOMY OVAL STOP / TAIL / TURN

Female-pin termination • Interchanges with competitive units; works with existing grommets and pigtails • Available in both red and amber

STOP / TAIL / TURN:

52182 Red
52182-5 Red, Retail Pack

STOP / TAIL / TURN KIT:

53092 Red (52182 + 92420 + 67000)
53092-5 Red (52182 + 92420 + 67000), Retail Pack

FRONT PARK / TURN:

52183 Yellow
52183-5 Yellow, Retail Pack

FRONT PARK / TURN KIT:

53093 Yellow (52183 + 92420 + 67000)

Material: Polycarbonate
 FMVSS: Red – I, P2, S, T; Yellow – I, P
 Finish: Red / Yellow
 Bulb: 32 / 3 CP Volts / Amps: 12V / 2.1A (I,S) / .59A (P,P2,T)
 Bracket: 43362, 43952, 43220, 43222, 43223
 Grommet: 92420, 92720
 Pigtail: 67000, 66825, 66812, 67010, 67011

SUPERNOVA® SURFACE MOUNT OVAL MID-TURN / MARKER LED LAMP

Meets compliance for SAE J914 Nov. '87 making lamp legal in all of North America • Meets California Title 13 requirements • Lamp is visible from driver's rearview mirror while flashing • Metal-core circuit board dissipates heat from electronic components to extend LED life • Tough lens and housing for impact resistance • Durable screw bosses withstand excessive screw torque without cracking • Industry-standard 122.2-mm mounting for easy retrofits • Great for heavy trucks and trailers

53493 Yellow

Material: Polycarbonate
 FMVSS: E, E2, P2
 Finish: Yellow
 Volts / Amps: 12V / .350A (E, E2) / .82A (P2)
 Accessory: Chrome Bezel 93773
 Pigtail: 66905, 66904, 66900

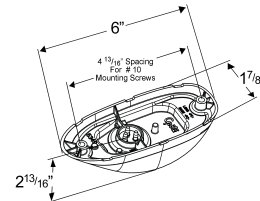

SUPERNOVA® OVAL SIDE TURN / MARKER LED LAMPS

Encapsulant potting for total circuit-board protection • Active reflector optics direct light, lamp exceeds SAE J914 Nov. '87 • Fits all competitive and popular grommets and brackets • Light is visible to driver during operation

- 52323** Yellow
- 52383** Yellow w / Black Theft-Resistant Flange
- 52353** Yellow w / Gray Theft-Resistant Flange
- 52393** Yellow w / Stainless-Steel Theft-Resistant Flange

Material: Polycarbonate
 FMVSS: E, P2
 Finish: Yellow
 Volts / Amps: 12V / .42A (E) / .1A (P2)
 Bracket: 43362, 43952, 43220, 43222, 43223
 Grommet: 92420, 92720
 Pigtail: 67002, 66841, 66815, 66816, 66845, 67005

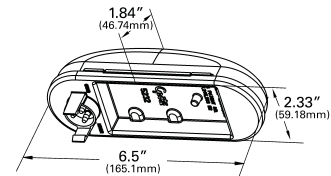

LED HYBRID SIDE-TURN / MARKER LAMP

Hybrid LED / incandescent technology provides a low cost-to-life ratio with an incandescent flashing function and an LED marker • 1,200-hour, field-replaceable mid-turn bulb • Hydrophobic vent filters in housing expel water vapor when lamp is lit to prevent water pooling inside lamp • Foam gasket between lens and housing provides protection against moisture intrusion • Sealed Packard® style connector minimizes potential failure points associated with conventional pigtail connections • Used on Navistar® vehicles

52423 Yellow

Material: Polycarbonate
 FMVSS: E, E2, P2
 Finish: Yellow
 Bulb: LED Volts / Amps: 12V / .06A (P2)
 Bulb: 3156K, 32 CP Volts / Amps: 12V / 2.1A (E, E2)
 Pigtail: 66826

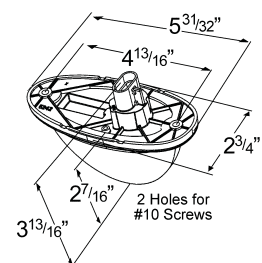

Stop / Tail / Turn Lamps

Feux Arrêt / Arrière / Direction Lámparas de Freno / Cuarto / Direccional

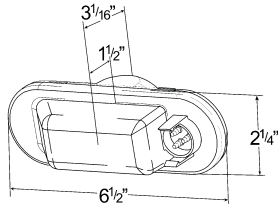

OVAL MALE-PIN TORSION MOUNT® III SIDE TURN / MARKER LAMP

Standard lamp on Great Dane* trailers • Torsion Mount® III, Gel-Mount® bulb cradle design minimizes bulb vibration • Extended dome for added visibility from front and rear • Fits standard oval lamp grommets and brackets • Contains reflex reflector • Exceeds SAE J914, Nov. '87

52533 Yellow

KITS:

52553 Yellow (52533 + 92420 + 67002)

Material: Polycarbonate
 FMVSS: A, E, P2, P3
 Finish: Yellow
 Bulb: 32 / 3 CP Volts / Amps: 12V / 2.1A (E) / .59A (P2,P3)
 Bracket: 43362, 43952, 43220, 43222, 43223, 43723
 Grommet: 92420, 92720
 Pigtail: 67002, 66841, 66815, 66816, 66845, 67005

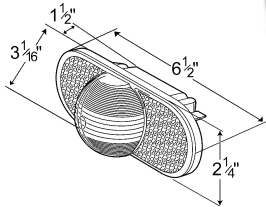

OVAL TORSION MOUNT® III SIDE TURN / MARKER LAMP

Torsion Mount® III, Gel-Mount® bulb cradle design minimizes bulb vibration
 • Extended dome for added visibility from front and rear • Fits standard oval lamp grommets and brackets • Exceeds SAE J914 Nov. '87
 • Contains reflex reflector

SIDE MARKER:

52512 Red

SIDE TURN / MARKER:

52513 Yellow

SIDE TURN / MARKER KIT:

52543 Yellow (52513 + 92420 + 67000)

Material: Polycarbonate
 FMVSS: Red - A, P2; Yellow - A, E, P2, P3
 Finish: Red / Yellow
 Bulb: 32 / 3 CP Volts / Amps: 12V / 2.1A (E) / .59A (P2,P3)
 Bracket: 43362, 43952, 43220, 43222, 43223, 43723
 Grommet: 92420, 92720
 Pigtail: 67000, 66812, 66825, 66843, 66844

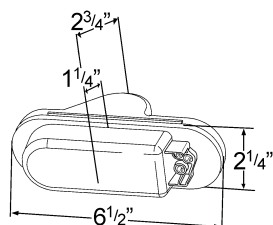

ECONOMY OVAL SIDE TURN / MARKER LAMP

Interchanges with competitive units; works with existing grommets and pigtails • Hermetic lens-to-housing seal • Vibration-resistant bulb mounting system • Standard female-pin termination

52193 Yellow

KITS:

52253 Yellow (52193 + 92420 + 67000)

Material: Polycarbonate
 FMVSS: A, E, P2
 Finish: Yellow
 Bulb: 32 / 2 CP Volts / Amps: 12V / 2.1A (E) / .48A (P2)
 Bracket: 43723, 43362, 43952, 43220, 43222, 43223
 Grommet: 92420, 92720
 Pigtail: 67000, 66825, 66812, 67010, 67011

SMALL AERODYNAMIC COMBINATION MARKER / SIDE TURN LAMP

One-way check valve expels water • High-impact base, polycarbonate lens • Retrofits to Sentry lamp 53063 and 53163 • Great upgrade / replacement on Freightliner® midturn lamps • Exceeds SAE J2039 June '94

SIDE TURN / MARKER:

52023 Yellow, Black Base
52063 Yellow, White Base

SIDE MARKER:

52062 Red, White Base

Material: Polycarbonate
 FMVSS: Red – P2, PC; Yellow – E, P2
 Finish: Black / White / Red / Yellow
 Bulb: 3157, 32 / 2 CP Volts / Amps: 12V / 2.1A (E) / .59A (P2,P3,PC)
 Pigtail: 66905, 66904, 66900, 66901, 66920, 66903
 Lens: Red 92892, Yellow 92893

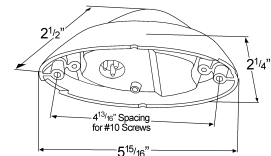

OEM STYLE SIDE TURN LAMP

Surface mount lamp • Combination turn signal and side marker (53853 only) • 4.54" mounting holes • Lens hermetically sealed (53833) to the base • Includes Packard® connector and mounting pad

53833 Yellow, Sealed, Non-Replaceable **new**
53843 Yellow, Bulb Replaceable **new**
53853 Yellow, Bulb Replaceable **new**

Material: Polycarbonate
 FMVSS: 53853, E, P2; 53833, 53843, E
 Finish: Yellow
 Bulb: 53833 - 3156, 26-Watt Volts / Amps: 12.8V / 2.1A
 Bulb: 53853 - 3157, 26 / 8-Watt Volts / Amps: 12.8 / 14.0V - 2.1A / .59A

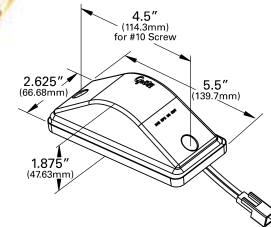

SEALED SENTRY COMBINATION MARKER / SIDE TURN LAMP

High-impact base • Uses male-pin termination; accepts UBS pigtail • Not recommended for rear of vehicles in padded dock applications • Yellow exceeds SAE J914 Nov. '87 • Sentry lamp is available only from Grote Industries

SIDE TURN / MARKER:

53062 Red, White Base
53063 Yellow, White Base

SIDE TURN:

53163 Yellow, Black Base

Material: Polycarbonate
 FMVSS: 53163 - E2; 53063 - E2, P2
 Finish: White / Black / Red / Yellow
 Bulb: Single Function - 21 CP Volts / Amps: 12V / 1.34A (E2)
 Bulb: Multi-Function - 21 / 6 CP Volts / Amps: 12V / 1.34A (E2) / .59A (P2)
 Pigtail: Multi-Function - 66905, 66900, 66903, 66904, Single Function - 66902

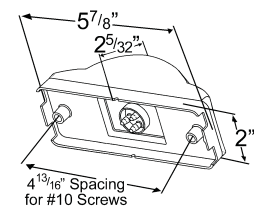

SENTRY SUPPLEMENTAL, HIGH-MOUNT STOP LAMP

Application for vehicles over 80" only • High impact base • Single filament bulb • Not recommended for rear of vehicle in padded dock applications • Must be used in conjunction with a legal CHMSL

54012 Red

Material: Polycarbonate
 FMVSS: U
 Finish: White / Red
 Bulb: 21 CP Volts / Amps: 12V / 1.34A
 Pigtail: 66902

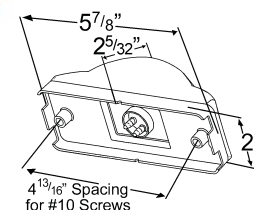

Stop / Tail / Turn Lamps

Feux Arrêt / Arrière / Direction Lámparas de Freno / Cuarto / Direccional

LED



01-5444-71



01-5445-71

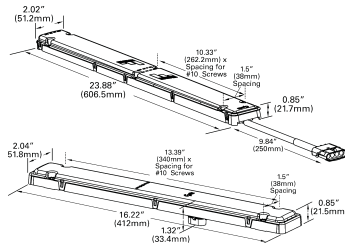

FONTAINE® REVOLUTION LED LAMP SYSTEM FOR TRAILERS OVER 80" WIDE

Unique and innovative lighting system developed for Fontaine® trailers

- Stop, tail, turn system utilizes one lamp that can be rotated for left-hand or right-hand installations
- Part number 01-5445-71 interchanges to Fontaine® part number 50918106 and part number 01-5444-71 interchanges to Fontaine® part number 50918107

01-5444-71

Red, CHMSL **new**

01-5445-71

Red, Stop / Tail / Turn, LH or RH **new**

Material: Acrylic / ABS
 FMVSS: P2, A, I, S, T (S / T / T); P2, U, U3 (CHMSL)
 Finish: Red
 Volts / Amps: 01-5444-71 – 12V / .03A / .21A
 Volts / Amps: 01-5445-71 – 12V / .127A / .21A / .21A

LED

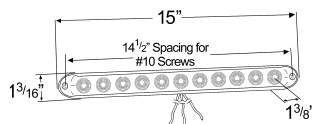

15" LED BAR LAMPS

11-LED configuration • 53582 can be mounted in vertical, horizontal or 45° applications • Sealed lamps

53582 Red, Stop / Tail / Turn

53582-5 Red, Stop / Tail / Turn, Retail Pack

Material: Polycarbonate
 FMVSS: 53582- I, S, T
 Finish: Black / Red
 Volts / Amps: 12V / .35A (S, I) / .04A (P2, T)

LED

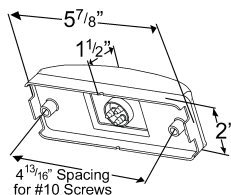

SUPERNOVA® LED TURTLEBACK® II SUPPLEMENTAL HIGH-MOUNT STOP / TURN CLEARANCE OR ID LAMP

Lamp functions as a marker, clearance, ID and supplemental high-mount stop or turn lamp

- Supplemental high-mount function provides greater visibility in a location that normally serves as an ID function or clearance function
- Sealed Turtleback® II lens profile makes lamp more durable and impact-resistant
- Circuit board coated with encapsulant potting provides protection from vibration, corrosion and moisture
- Three-wire termination
- LED lamps are an excellent light source that consumes less power

54002 Red

Material: Polycarbonate
 FMVSS: P2, U
 Finish: Red
 Volts / Amps: 12V / .25A (U) / .025A (P2)
 Bracket: 43030, 43050
 Pigtail: 66904, 66905, 66900, 66903

Stop / Tail / Turn Lamps

Feux Arrêt / Arrière / Direction Lámparas de Freno / Cuarto / Direccional

HI COUNT® LED RECTANGULAR STOP / TAIL / TURN LAMP

Vertical or horizontal mount • Hermetically sealed polycarbonate lens and body • Fits existing competitive grommets and connections • Standard female-pin connection provides easy retrofits • LED instant-on feature provides early stop warning for trailing motorists • Yellow lens meets photometric requirements for front park and turn • Potted circuit board protects against vibration and corrosion

- G4502** Red new
- G4502-5** Red, Retail Pack new
- G4503** Yellow new
- G4503-5** Yellow, Retail Pack new

Material: Polycarbonate
 FMVSS: I, P2, S, T
 Finish: Red / Yellow
 Volts / Amps: Red - 12V / .50A (I,S) / .07A (P2,T)
 Volts / Amps: Yellow - 12V / .52A (I) / .09A (P)
 Bracket: 43212
 Grommet: 94180
 Pigtail: 67000, 67090, 66825, 66812, 67010, 67011

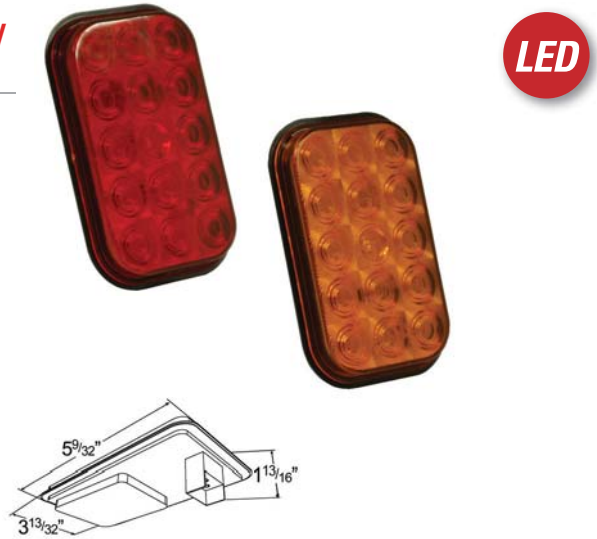

RECTANGULAR STOP / TAIL / TURN LAMP

Rubber shock mounted bulb socket • Hermetic lens-to-housing sealed lamp • Industry-standard female-pin connection

STOP / TAIL / TURN LAMP (DOUBLE CONTACT):
52202 Red

PARK / TURN LAMP (DOUBLE CONTACT):
52203 Yellow

Material: Polycarbonate
 FMVSS: 52202 - I, P2, S, T; 52203 - I, P
 Finish: Red / Yellow
 Bulb: 32 / 2 CP Volts / Amps: 52202- 12V / 2.1A (S, I) / .48A (P2,T)
 Volts / Amps: 52203- 12V / 2.1A (I) / .48A (P)
 Bracket: 43212
 Grommet: 94180
 Pigtail: 67000, 66825, 66812, 67010, 67011

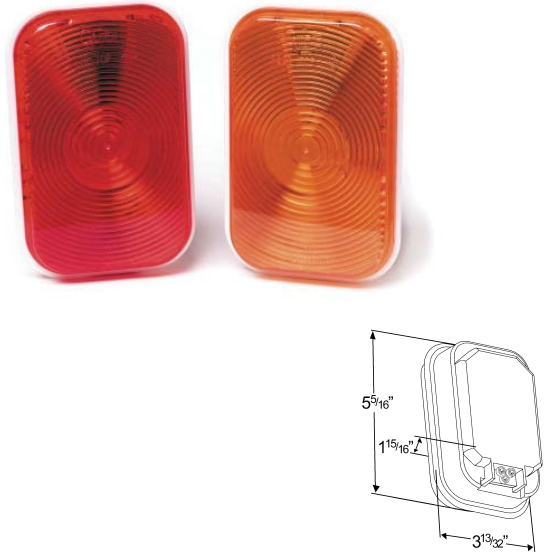

RECTANGULAR SURFACE-MOUNT TURN LAMP

Double-filament bulb provides park and turn function • 3 1/2" mounting centers • Less than 75 sq. cm lens area • For use on vehicles less than 80" wide

- 53132** Red
- 53133** Yellow

Material: Steel / Polycarbonate
 FMVSS: Red - I, S, T; Yellow - I, P
 Bulb: 2057, 32 / 2 CP Volts / Amps: 12V / 2.1A (I,S) / .48A (P, T)
 Lens: Red 92762, Yellow 92763, Clear 92761, Blue 92765

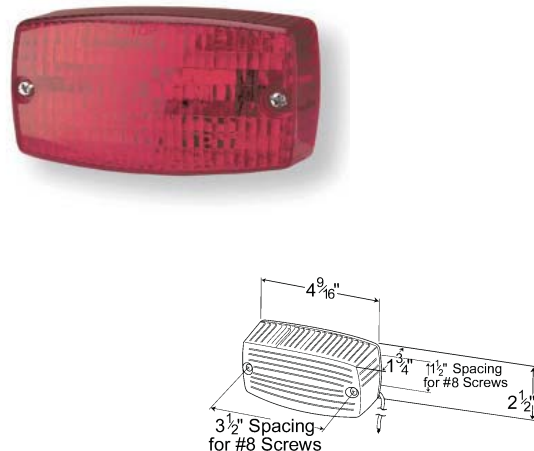

Stop / Tail / Turn Lamps

Feux Arrêt / Arrière / Direction Lámparas de Freno / Cuarto / Direccional

LED

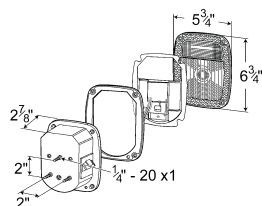

SUPERNOVA® THREE-STUD METRI-PACK® REPLACEMENT LED LAMP

Features Grote's SuperNova® single-LED technology in both the S / T / T and license function • Encapsulant potting for total circuit-board protection

• Replaces GM® 15613944 and 15565732 (53630), 15613943 and 15565731 (53640) • Replaces Navistar® 1661282C91 (53630), 1661281C91 (53640)

53630 Red, RH

53640 Red, LH

Material: Polycarbonate / Acrylic

FMVSS: A, I, L, (2)R, S, T

Finish: Red / Black

Bulb: 1156 32CP (L) Volts / Amps: 12V / 2.1A (R2) / .35A (I,S) / .16A (L, T)

Bracket: 43842, 43022, 43272

Pigtail: 68680

Lens: Red 91302

LED

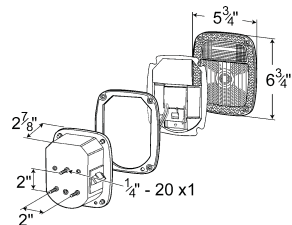

SUPERNOVA® THREE-STUD METRI-PACK® REPLACEMENT LED LAMP WITH DOUBLE CONNECTOR

Features Grote's SuperNova® single-LED technology in both the S / T / T and license function • Encapsulant potting for total circuit-board protection

• Replaces Navistar® 1661281C91 • Back-up function remains incandescent

WITH LICENSE LAMP:

53650 Red

Material: Polycarbonate / Acrylic

FMVSS: A, I, L, (2)R, S, T

Finish: Red / Black

Volts / Amps: 12V / 2.1A (R2) / .35A (I,S) / .16A (L, T)

Bracket: 43842, 43022, 43272

Pigtail: 68680

Lens: Red 91302

LED

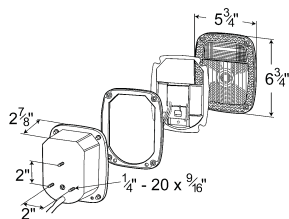

SUPERNOVA® THREE-STUD REPLACEMENT LED LAMP

Features Grote's SuperNova® single-LED technology in both the S / T / T and license functions • Encapsulant potting for total circuit-board protection

• Replaces Chevrolet® / GMC® 370867 and 370868 • Replaces Jeep® SF5457197 and SF5457198 • Replaces Peterbilt® 16-02600R and 16-02600L

50920 Red

Material: Polycarbonate / Acrylic

FMVSS: A, I, L, (2)R, S, T

Finish: Red / Black

Bulb: 32 CP Volts / Amps: 12V / 2.1A (R2) / .35A (I, S) / .16A (L, T)

Bracket: 43842, 43022, 43272

Lens: Red 91302

Stop / Tail / Turn Lamps

Feux Arrêt / Arrière / Direction Lámparas de Freno / Cuarto / Direccional

HI COUNT® LED BOX LAMP

All functions utilize LED technology • Concentric, multiple-diode design
 • Gasket between lens and housing protects against moisture intrusion
 • Potted circuit board protects against vibration and corrosion • Side-marker version directly replaces Jeep® Wrangler® lamps through 2006
 • Sidemarker version features circuit-board protection that is compatible with the existing flasher technology • 3-stud mounting design incorporates ground function • Mounting hardware and instructions included for easy installation / retrofit

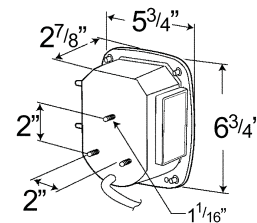

WITH SIDEMARKER:	
G5202	Red, RH, w / Sidemarker new
G5212	Red, LH w / License Window and Sidemarker new
WITHOUT SIDEMARKER:	
G5092-5	Red, LH w / License Window, Retail Pack
G5082-5	Red, RH, Retail Pack

Material: Polycarbonate / Acrylic
 FMVSS: RH - A, I, (2)R, S, T, LH - A, I, L, (2)R, S, T
 Finish: Red / Black
 Voltage Amp: LH w / o Sidemarker - 12V / .21A (I,S) / .34A (R2) / .12A (L)
 Voltage Amp: RH w / o Sidemarker - 12V / .21A (I,S) / .34A (R2) / .06A (T)
 Voltage Amp: LH w / Sidemarker - 12V / 1.4A (I,S) / .34A (R2) / .12A (T, L)
 Voltage Amp: RH w / Sidemarker - 12V / 1.4A (I,S) / .34A (R2) / .06A (T)
 Bracket: 43842, 43022, 43272

THREE-STUD METRI-PACK® REPLACEMENT LAMP

Replaces GM® 15613943 and 15565731 • Replaces Navistar® 1661281C91
 • Features a license window • Metri-Pack® connector on right side

53712	Red, LH
53702	Red, RH

Material: Polycarbonate / Acrylic
 FMVSS: A, I, L, (2)R, S, T
 Finish: Red / Black
 Bulb: 1156, 32 CP Volts / Amps: 12V / 2.1A (R2)
 Bulb: 1157, 32 / 3 CP Volts / Amps: 12V / 2.1A (I,S) / .59A (T, L)
 Bracket: 43842, 43272, 43022
 Pigtail: 68680
 Lens: Red 91302

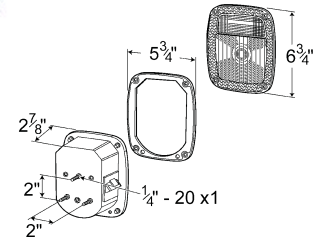

FORD® REPLACEMENT BOX LAMPS

Junction box with Ford OEM connector • Features a license window
 • Replaces Ford® F4HZ-13405-BA-LH and F4HZ-13404-A-RH

53782	Red, RH
53792	Red, LH

Material: Polycarbonate / Acrylic
 FMVSS: A, I, L, P2, (2)R, S, T
 Finish: Red / Black
 Bulb: 3157, 32 CP Volts / Amps: 12V / 2.1A (R2)
 Bulb: 3157, 32 / 3 CP Volts / Amps: 12V / 2.1A (I, S) / .59A (T, L, P2)
 Bracket: 43842, 43022, 43272
 Pigtail: 01-6868-82
 Lens: Red 91302

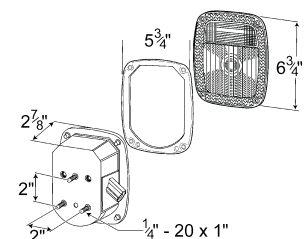

Stop / Tail / Turn Lamps

Feux Arrêt / Arrière / Direction Lámparas de Freno / Cuarto / Direccional



TWO-STUD METRI-PACK® REPLACEMENT LAMP

Features a license window • Metri-Pack® connector on left side
• Replaces Mack® 14M052M

53722 Red

Material: Polycarbonate / Acrylic
FMVSS: A, I, L, (2)R, S, T
Finish: Red / Black
Bulb: 1156, 32 CP Volts / Amps: 12V / 2.1A (R2)
Bulb: 1157, 32 / 3 CP Volts / Amps: 12V / 2.1A (I, S) / .59A (T, L)
Bracket: 43842, 43272, 43022
Pigtail: 68680
Lens: Red 91302

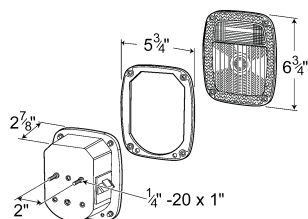

THREE-STUD METRI-PACK® REPLACEMENT LAMP WITH DOUBLE CONNECTOR

Features a license window • Metri-Pack® connectors on both sides
• Replaces Navistar® 1661281C91

53762 Red

Material: Polycarbonate / Acrylic
FMVSS: A, I, L, (2)R, S, T
Finish: Red / Black
Bulb: 1156, 32 CP Volts / Amps: 12V / 2.1A (R2)
Bulb: 1157, 32 / 3 CP Volts / Amps: 12V / 2.1A (I, S) / .59A (T, L)
Bracket: 43842, 43022, 43272
Pigtail: 68680
Lens: Red 91302

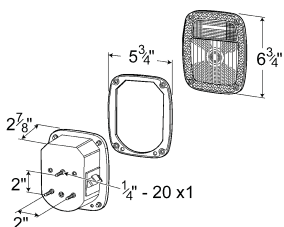

TORSION-MOUNT® UNIVERSAL REPLACEMENT LAMP

6-in-1 lamp • Four screw posts in junction box • Fits all 3-stud mounting on heavy-duty trucks

52902 Red, RH

52912 Red, LH

Material: Polycarbonate / Acrylic
FMVSS: A, I, L, (2)R, S, T
Finish: Red / Black
Bulb: 1156, 32 CP Volts / Amps: 12V / 2.1A (R2)
Bulb: 1157, 32 / 3 CP Volts / Amps: 12V / 2.1A (I, S) / .59A (T, L)
Bracket: 43022, 43272, 43842
Lens: Red 91302

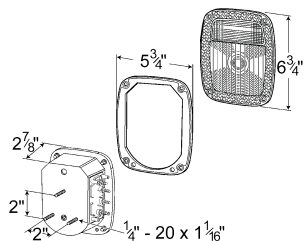

Stop / Tail / Turn Lamps

Feux Arrêt / Arrière / Direction Lámparas de Freno / Cuarto / Direccional

61

STOP / TAIL / TURN LAMPS

TORSION MOUNT® THREE-STUD GMC® REPLACEMENT LAMP

Junction box with quick splice or ring connectors • Replaces GMC® 715103 or 2063933 (RH) • Replaces GMC® 715104 or 2063931 (LH)

50902 Red, RH

50912 Red, LH

Material: Polycarbonate / Acrylic

FMVSS: A, I, L, (2)R, S, T

Finish: Red / Black

Bulb: 1156, 32 CP Volts / Amps: 12V / 2.1A (R)

Bulb: 1157, 32 / 3 CP Volts / Amps: 12V / 2.1A (I,S) / .59A (T, L)

Bracket: 43842, 43022, 43272

Lens: Red 91302

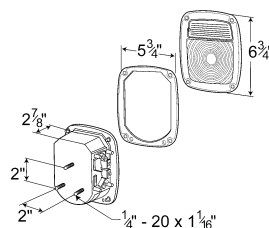

TORSION MOUNT® THREE-STUD NAVISTAR® / VOLVO® REPLACEMENT LAMP

Replaces LH Navistar® 424537-C91 and 424538-C91 • Replaces RH Volvo® 83701-0002 • Replaces RH Navistar® 424539-C91 • Replaces LH Volvo® 83702-0002

50942 Red, RH

50952 Red, LH

Material: Polycarbonate / Acrylic

FMVSS: A, I, L, (2)R, S, T

Finish: Red / Black

Bulb: 1156, 32 CP Volts / Amps: 12V / 2.1A (R)

Bulb: 1157, 32 / 3 CP Volts / Amps: 12V / 2.1A (I,S) / .59A (T, L)

Bracket: 43842, 43272, 43022

Lens: Red 91302

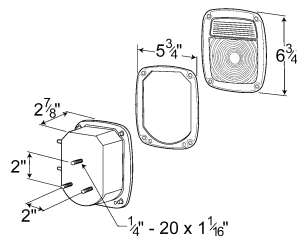

TORSION MOUNT® TWO-STUD MACK / DODGE® REPLACEMENT LAMP

Fits both right hand and left hand • Includes OE 39" pigtail with ring terminal • Replaces Mack® 14M0444RP1 and 14M0444RP4 shock mount • Features a license window

50992 Red

Material: Polycarbonate / Acrylic

FMVSS: A, I, L, (2)R, S, T

Finish: Red / Black

Bulb: 1156, 32 CP Volts / Amps: 12V / 2.1A (R)

Bulb: 1157, 32 / 3 CP Volts / Amps: 12V / 2.1A (I,S) / .59A (T, L)

Bracket: 43842, 43272, 43022

Lens: Red 91302

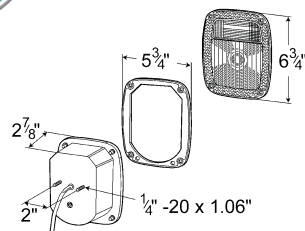

grote.com

61

Stop / Tail / Turn Lamps

Feux Arrêt / Arrière / Direction Lámparas de Freno / Cuarto / Direccional

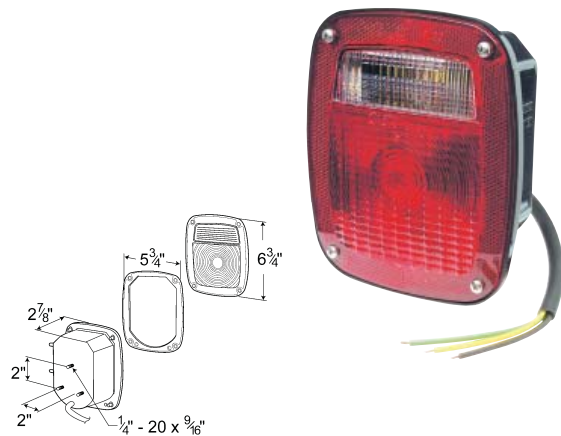

THREE-STUD PETERBILT* / CHEVROLET* / JEEP* / GMC* REPLACEMENT LAMP WITH PIGTAIL

Replaces Peterbilt 16-02600R and 16-02600L • Replaces Chevrolet* / GMC* 370867 and 370868 • Replaces Jeep* SF5457197 and SF5457198
 • Features license window

50972 Red
50972-5 Red, Retail Pack

Material: Polycarbonate / Acrylic
 FMVSS: A, I, L, (2)R, S, T
 Finish: Red / Black
 Bulb: 1156, 32 CP Volts / Amps: 12V / 2.1A (R)
 Bulb: 1157, 32 / 3 CP Volts / Amps: 12V / 2.1A (I,S) / .59A (T, L)
 Bracket: 43842, 43022, 43272
 Lens: Red 91302



THREE-STUD, CHEVROLET* / FORD* / JEEP* REPLACEMENT LAMP WITH SIDEMARKER LAMP AND MOLDED PIGTAIL TERMINATION

Rounded molded terminals • Replaces Chevrolet* / GMC* 477331 and 47332 (RH) • Replaces Jeep* SF5758255 and SF5758254 (LH) • Features sidemarkers • No license window

52802 Red, RH
52812 Red, LH

Material: Polycarbonate / Acrylic
 FMVSS: RH - A, I, P2, R2, S, T; LH - A, I, L, P2, R2, S, T
 Finish: Red / Black
 Bulb: 1156, 32 CP Volts / Amps: 12V / 2.1A (R2)
 Bulb: 1157, 32 / 3 CP Volts / Amps: 12V / 2.1A (I,S) / .59A (T, L)
 Bulb: 193 Volts / Amps: 12V - .33A (P2)
 Bracket: 43842, 43022, 43272
 Lens: Red 91302



TORSION MOUNT® TWO-STUD DODGE* REPLACEMENT LAMP WITH SIDEMARKER LAMP AND MOLDED PIGTAIL TERMINATION

Replaces Dodge* 4114562 (RH) • Replaces Dodge* 4114561 and 4114563 (LH)

WITHOUT LICENSE WINDOW:

52822 Red, RH

WITH LICENSE WINDOW:

52832 Red, LH

Material: Polycarbonate / Acrylic
 FMVSS: RH - A, I, P2, (2)R, S, T, LH - A, I, L, P2, R2, S, T
 Finish: Red / Black
 Bulb: 1156, 32 CP Volts / Amps: 12V / 2.1A (R)
 Bulb: 1157, 32 / 3 CP Volts / Amps: 12V / 2.1A (I,S) / .59A (T, L)
 Bulb: 193 Volts / Amps: 12V - .33A (P2)
 Bracket: 43842, 43022, 43272
 Lens: Red 91302

TORSION MOUNT® TWO-STUD DODGE® REPLACEMENT LAMP

Standard-mount pigtail • Replaces Dodge® truck 3895020 and 3895021
• Features license window

52602 Red

Material: Polycarbonate / Acrylic
FMVSS: A, I, L, (2)R, S, T
Finish: Red / Black
Bulb: 1156, 32 CP Volts / Amps: 12V / 2.1A (R)
Bulb: 1157, 32 / 3 CP Volts / Amps: 12V / 2.1A (I,S) / .59A (T, L)
Bracket: 43842, 43022, 43072
Lens: Red 91302

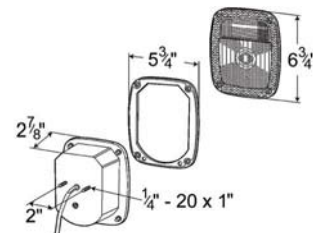

TWO-STUD FORD® REPLACEMENT LAMP WITH PIGTAIL AND MOLDED PLUG

Studs on 1 3/4" centers • Retrofits Ford® OEM C7TZ13404C, D0TZ13404A, D3KZ13404A, D3TZ13403B, E2TB13404A, E2TB13405A • Features License Window

52972 Red

Material: Polycarbonate / Acrylic
FMVSS: A, I, L, (2)R, S, T
Finish: Red / Black
Bulb: 1156, 32 CP Volts / Amps: 12V / 2.1A (R)
Bulb: 1157, 32 / 3 CP Volts / Amps: 12V / 2.1A (I,S) / .59A (T, L)
Bracket: 43842, 43022, 43072
Lens: Red 91302

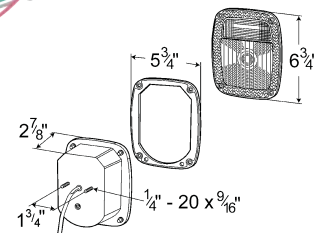

Stop / Tail / Turn Lamps

Feux Arrêt / Arrière / Direction Lámparas de Freno / Cuarto / Direccional

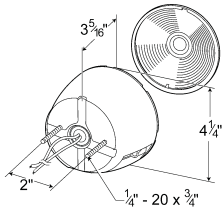

4" DURAMOLD® TWO-STUD MOUNT COMBINATION LAMP

Snap-on lens • Rubber compression-sealed pigtail • Removable studs for school bus application

WITH LICENSE WINDOW:

50852 Red
50852-5 Red, Retail Pack

WITHOUT LICENSE WINDOW:

50862 Red
50862-5 Red, Retail Pack

Material: DURAMOLD® / Polycarbonate
FMVSS: I, L, P2, S, T
Finish: Red / Black
Bulb: 1157, 32 / 3 CP Volts / Amps: 12V / 2.1A (I,S) / .59A (P2,T,L)
Bracket: 43272
Pigtail: 68150
Lens: Red 90232, Yellow 90233, Blue 90235

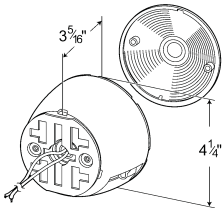

4" DURAMOLD® UNIVERSAL MOUNT COMBINATION LAMP

2-screw lens • Less than 75 sq. cm. of effective, projected luminous lens area • Rubber compression-sealed pigtail • Features license window • For use on vehicles less than 80" wide

WITH LICENSE WINDOW:

50872 Red
50872-5 Red, Retail Pack

Material: DURAMOLD® / Acrylic
FMVSS: I, L, P2, S, T
Finish: Red / Black
Bulb: 1157, 32 / 3 CP Volts / Amps: 12V / 2.1A (I,S) / .59A (L,P2,T)
Bracket: 43272
Pigtail: 68150
Lens: Red 91482

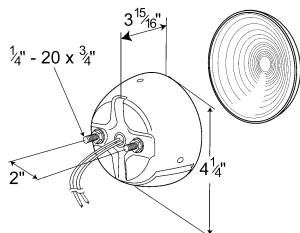

4" STEEL TWO-STUD MOUNT COMBINATION LAMP

Less than 75 sq. cm. of effective, projected luminous lens area • Heavy-gauge, formed steel body • Rubber compression-sealed pigtail • For use on vehicles less than 80" wide

WITH LICENSE WINDOW:

50882 Red

WITHOUT LICENSE WINDOW:

50892 Red

Material: Steel / Acrylic
FMVSS: 50882 – I, L, P2, S, T; 50892 – I, P2, S, T
Finish: Red / Black
Bulb: 1157, 32 / 3 CP Volts / Amps: 12V / 2.1A (I,S) / .59A (L,P2,T)
Bracket: 43272
Pigtail: 68150
Lens: Red 90252

Stop / Tail / Turn Lamps

Feux Arrêt / Arrière / Direction Lámparas de Freno / Cuarto / Direccional

HI COUNT® LED 2-SIDED LAMP WITH SIDEMARKER

LED

Attractive multiple-diode design • 2-stud mounting bolts • Attached three-wire harness

- G5530** Red and Yellow, LH **new**
- G5530-5** Red and Yellow, LH, Retail Pack **new**
- G5540** Red and Yellow, RH **new**
- G5540-5** Red and Yellow, RH, Retail Pack **new**
- G5543-5** Yellow and Yellow, w / Packard Connector **new**

Material: ABS / Acrylic
FMVSS: I, T, P, P2
Finish: Chrome / Red / Amber
Volts / Amps: 12V / .775A (I) / .038A (P / P2 / T)

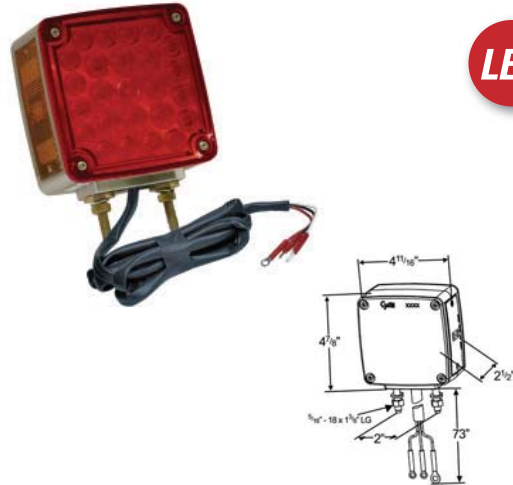

TWO-STUD PLUG-IN LAMP

Incorporates sidemarker light • Fits right or left side • Keyed, plug-in receptacle, accepts OEM harness • Standard with Navistar® / Volvo®
• Vertical mount

- 55470** Red and Yellow

Material: Polycarbonate / Acrylic
FMVSS: A, I, P2
Finish: Black / Red / Yellow
Bulb: 1156, 32 CP Volts / Amps: 12V / 2.1A (I)
Bulb: 193, 2 CP Volts / Amps: 12V / .33A (P2)
Lens: Red 91502, Yellow 91503; Sidemarker: Yellow 91513

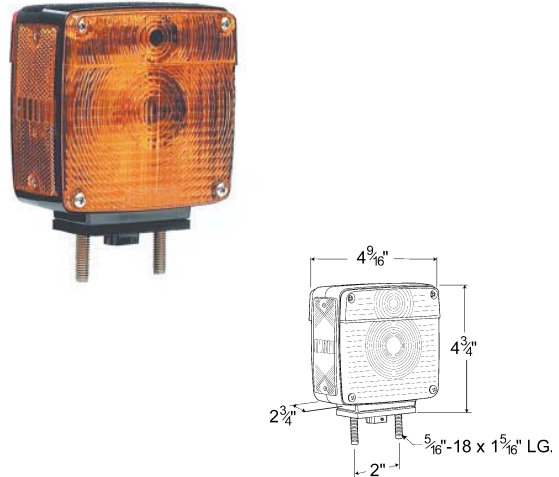

TWO-STUD CHROME LAMP WITH PIGTAIL

Switch lens for right or left applications • Ground wire plus tab • PVC wire jacket material • 73" color-coded pigtail • Vertical mount

- 55340** Red and Yellow

Material: ABS / Acrylic
FMVSS: A, I, P2
Finish: Chrome / Red / Yellow
Bulb: 1156, 32 CP Volts / Amps: 12V / 2.1A (I)
Bulb: 193, 2 CP Volts / Amps: 12V / .33A (P2)
Lens: Red 90482, Yellow 90483; Sidemarker: Yellow 94643 (91513 Prior to 2009)

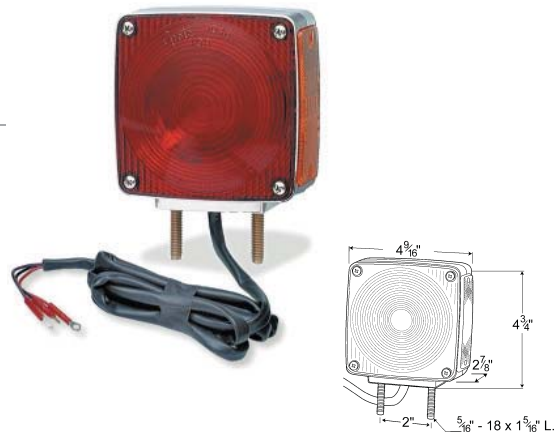

Stop / Tail / Turn Lamps

Feux Arrêt / Arrière / Direction Lámparas de Freno / Cuarto / Direccional

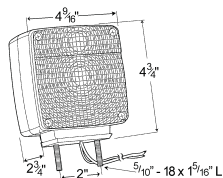

TWO-STUD LAMP WITH PIGTAIL

High-heat acrylic lens • 2" mounting centers • Incorporates sidemarker light • Replaces Chevrolet* / GMC* 2017747 (RH) and 2017751 (LH)

55410 Red and Yellow RH

55420 Red and Yellow LH

Material: Polycarbonate / Acrylic
 FMVSS: A, I, P, P2
 Finish: Black / Red / Yellow
 Bulb: 1156, 32 CP Volts / Amps: 12V / 2.1A (I)
 Bulb: 193, 2 CP (X2) Volts / Amps: 12V / .66A (P,P2)
 Lens: Red 91502, Yellow 91503; Sidemarker: Yellow 91513

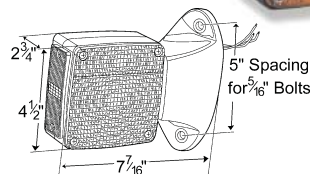

PEDESTAL-MOUNT LAMP WITH PIGTAIL

ABS body • Polycarbonate pedestal for fender contours • Incorporates sidemarker light • Replaces Chevrolet* / GMC* 2017745 and 2006674 (RH) • Replaces Chevrolet* / GMC* 2017746 and 2006673 (LH)

55430 Red and Yellow RH

55440 Red and Yellow LH

Material: ABS / Acrylic
 FMVSS: A, I, P, P2
 Finish: Black / Red / Yellow
 Bulb: 1156, 32 CP Volts / Amps: 12V / 2.1A (I)
 Bulb: 193, 2 CP (x2) Volts / Amps: 12V / .66A (P,P2)
 Lens: Red 91502, Yellow 91503; Sidemarker: Yellow 91513

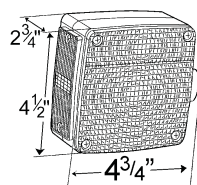

DOUBLE-FACE TURN SIGNAL / MARKER LAMP

Forward-facing park lamp function is FMVSS compliant • Can be used as a front turn lamp, front turn signal, or sidemarker • High-heat-resistant acrylic lens • Durable ABS housing design • Fits OE harness

55510 Red and Yellow RH

55520 Red and Yellow LH

Material: ABS / Acrylic
 FMVSS: A, I, P, P2
 Finish: Black / Red / Yellow
 Bulb: 1156, 32 CP Volts / Amps: 12V / 2.1A (I)
 Bulb: 193, 2 CP (X2) Volts / Amps: 12V / .66A (P, P2)
 Lens: Red 91502, Yellow 91503; Sidemarker: 91513

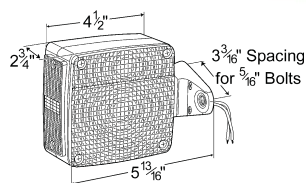

PEDESTAL-MOUNT LAMP WITH PIGTAIL

High-heat acrylic lens • ABS body • Incorporates sidemarker light • Replaces Chevrolet* / GMC* 694628 (RH) • Replaces Chevrolet* / GMC* 694627 (LH)

55450 Red and Yellow RH

55460 Red and Yellow LH

Material: ABS / Acrylic
 FMVSS: A, I, P, P2
 Finish: Black / Red / Yellow
 Bulb: 1156, 32 CP Volts / Amps: 12V / 2.1A (I)
 Bulb: 193, 2 CP (X2) Volts / Amps: 12V / .66(P,P2)
 Lens: Red 91502, Yellow 91503; Sidemarker: Yellow 91513

Stop / Tail / Turn Lamps

Feux Arrêt / Arrière / Direction Lámparas de Freno / Cuarto / Direccional

HI COUNT® LED DOUBLE FACE LAMP

Attractive multiple-diode design • Heavy-duty housing with hard-wired terminations for variable wiring options • Two-wire double-contact installation

- G5300** Red and Yellow new
- G5300-5** Red and Yellow, Retail Pack new

Material: Acrylic / Die Cast
 FMVSS: I, T
 Finish: Chrome / Red / Amber
 Volts / Amps: 12V / .77A (I) / .038A (T)
 Lens: Red 92062, Yellow 92063

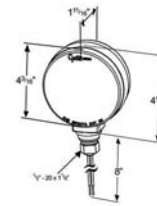

4" ZINC DIE-CAST DOUBLE-FACE LAMP

Shows yellow to front, red to rear • Less than 75 sq cm of effective, projected luminous lens area • For use on vehicles less than 80" wide

DOUBLE CONTACT:

- 53000** Red and Yellow, Chrome-Plated
- 53020** Red and Yellow, Black Enamel Finish
- 53023** Yellow and Yellow, Black Enamel Finish

SINGLE CONTACT:

- 56000** Red and Yellow, Chrome-Plated
- 56020** Red and Yellow, Black Enamel Finish

Material: Zinc Die-cast / Acrylic
 FMVSS: Double – I, P; Single – I
 Finish: Chrome / Black / Red / Yellow
 Bulb: Double – 1157, 32 / 3 CP Volts / Amps: 12V - .59A (P) / 2.1A (I)
 Bulb: Single – 1156, 32 CP Volts / Amps: 12V / 2.1A (I)
 Pigtail: 68130, 68170 Lens: Red 91582, Yellow 91583, Clear 91581

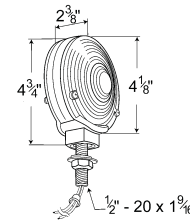

4" ZINC DIE-CAST SINGLE-FACE LAMP

Less than 75 sq. cm. of effective, projected luminous lens area • For use on vehicles under 80" wide • Wire exit includes a grommet to protect the jacket from abrasion

DOUBLE CONTACT:

- 53032** Red, Chrome-Plated
- 53052** Red, Black Enamel Finish

SINGLE CONTACT:

- 56032** Red, Chrome-Plated
- 56033** Yellow, Chrome-Plated
- 56052** Red, Black Enamel Finish

Material: Zinc Die-cast / Acrylic
 FMVSS: Double – I, S, T; Single – I, S
 Finish: Chrome / Black / Red / Yellow
 Bulb: Double - 1157, 32 / 3 CP Volts / Amps: 12 V - .59(P,T) / 2.1(I) A
 Bulb: Single - 1156, 32 CP Volts / Amps: 12 V - 2.1(I,S) A
 Pigtail: 68130, 68170 Lens: Red 91582, Yellow 91583, Clear 91581

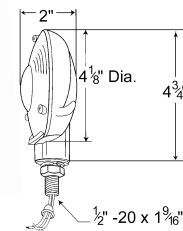

THIN-LINE ZINC DIE-CAST DOUBLE-FACE LAMP

For fender or front bracket mount • Shows yellow to front, red to rear • Wire exit has a grommet to protect the jacket from abrasion • Single contact

- 55280** Red and Yellow, Baked Aluminum Finish
- 55290** Red and Yellow, Triple Chrome-Plated

Material: Zinc Die-cast / Acrylic
 FMVSS: I
 Finish: Chrome / Aluminum / Red / Yellow
 Bulb: 1156, 32 CP Volts / Amps: 12V / 2.1A
 Pigtail: 68170 Lens: Red 90232, Yellow 90233, Blue 90235

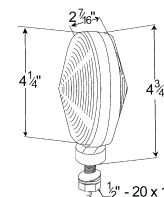

Stop / Tail / Turn Lamps

Feux Arrêt / Arrière / Direction Lámparas de Freno / Cuarto / Direccional

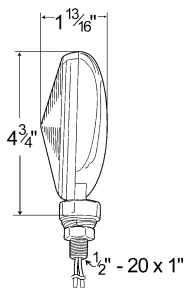

THIN-LINE ZINC DIE-CAST SINGLE-FACE LAMP

Snap-grip acrylic lens • Rubber O-rings • Easy bulb and lens replacement
• Wire exit has a grommet to protect the jacket from abrasion

DOUBLE CONTACT:

- 50652** Red, Chrome-Plated
- 50662** Red, Baked Aluminum Finish
- 53053** Yellow, Black Enamel Finish

SINGLE CONTACT:

- 55232** Red, Baked Aluminum Finish
- 56053** Yellow, Black Enamel Finish

Material: Zinc Die-cast / Acrylic
FMVSS: Double – I, S, T; Red, Single – I, S; Yellow – I, P; Yellow, Single - I
Finish: Chrome / Black / Aluminum / Red / Yellow
Bulb: Double – 1157, 32 / 3 CP Volts / Amps: 12V / 2.1A (I,S) / .59A (P, T) A
Bulb: Single – 1156, 32 CP Volts / Amps: 12V / 2.1A (I,S)
Pigtail: 68130, 68170
Lens: Red 90232, Blue 90235, Yellow 90233

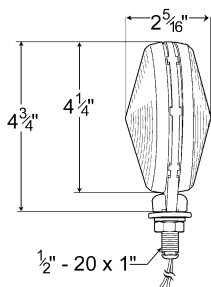

THIN-LINE DURAMOLD® DOUBLE-FACE LAMP

Easy snap-on lenses • Molded-in baffle • Molded-in O-ring • Wire exit has a grommet to protect jacket against abrasion

DOUBLE CONTACT:

- 50630** Red and Yellow
- 50630-5** Red and Yellow, Retail Pack

SINGLE CONTACT:

- 55220** Red and Yellow
- 55220-5** Red and Yellow, Retail Pack
- 55223** Yellow and Yellow
- 55223-5** Yellow and Yellow, Retail Pack

Material: DURAMOLD® / Acrylic
FMVSS: Double – I, P; Single – I
Finish: Gray / Red / Yellow
Bulb: Double – 1157, 32 / 3 CP Volts / Amps: 12V / 2.1A (I) / .59A (P)
Bulb: Single – 1156, 32 CP Volts / Amps: 12V / 2.1A (I)
Pigtail: 68170, 68130
Lens: Red 90232, Yellow 90233, Blue 90235

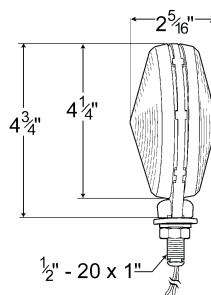

DURAMOLD® SINGLE-FACE LAMP

Easy snap-on lens • Molded-on baffle • Rubber plug-in pedestal

DOUBLE CONTACT:

- 50642** Red
- 50642-5** Red, Retail Pack

SINGLE CONTACT:

- 55242** Red
- 55243** Yellow

Material: DURAMOLD® / Polycarbonate
FMVSS: Double – I, S, T; Red, Single – I, S; Yellow, Single - I
Finish: Gray / Red / Yellow
Bulb: Double – 1157, 32 / 3 CP Volts / Amps: 12V / 2.1A (I,S) / .59A (T)
Bulb: Single – 1156, 32 CP Volts / Amps: 12V / 2.1A (I,S)
Pigtail: 68130, 68170
Lens: Red 90232, Blue 90235, Yellow 90233

Stop / Tail / Turn Lamps

Feux Arrêt / Arrière / Direction Lámparas de Freno / Cuarto / Direccional

STEEL SINGLE-FACE LAMP

Snap-ring lens application • Two-wire pigtail • Long-life bulb

DOUBLE CONTACT:

50352 Red

Material: Steel / Acrylic
 FMVSS: I, P2, P3, S, T
 Finish: Black / Red
 Bulb: 1157, 32 / 3 CP Volts / Amps: 12 V - 2.1(I,S) / .59(P2,P3,T) A
 Accessory: Snap Ring 99593
 Pigtail: 68130
 Lens: Red 90012, Clear 90011, Yellow 90013

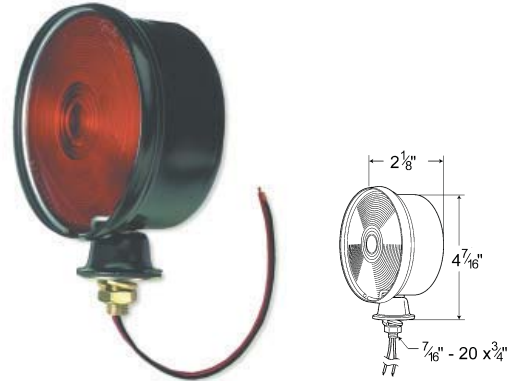

7" STOP /TAIL /TURN LED LAMP

Encapsulant potting provides protection for the circuit board • UV-protected lenses • Male .180 bullet termination • Flat-back installation (no cut-outs required) • Install using #10 screws

STOP / TAIL / TURN LAMP

53422 Red, Stop, Tail, Turn Lamp w / Reflex

SINGLE FUNCTION:

55982 Red, Turn Lamp w / Reflex
55983 Yellow, Front Turn Lamp w/ Reflex
55992 Red, Turn Lamp w / o Reflex
55993 Yellow, Turn Lamp w / o Reflex

Material: Polycarbonate
 FMVSS: 53422 - A, I, P2, S, T; 55982 - A, I, S; 55983 - A, I; 55992 / 3 - I
 Finish: Red / Yellow
 Volts / Amps: S / T / T - 12 V - .39(A,I) / .03(P2,T) A
 Volts / Amps: Single Function - 12 V - .39(I,S) A
 Accessory: Mounting Pad: 99140
 Bracket: 93982

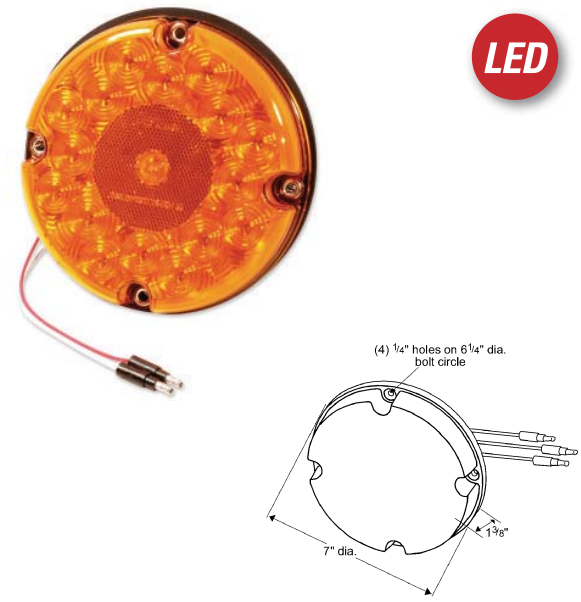

7" LED ARROW LENS TURN LAMP

Large arrow pattern makes it easier for road traffic to identify turning vehicles • Meets FMVSS 108 Front and Rear Turn requirements • Auxiliary for mid-turn and / or wide-turn indications • Surface mount for easy installation • UV-coated lens prevents weathering from the elements • Install using #10 screws

53883 Yellow, Turn Lamp **new**

Material: Polycarbonate
 FMVSS: I
 Finish: Yellow
 Volts / Amps: 12V - .327 A
 Accessory: Mounting Pad: 99140
 Bracket: 93982

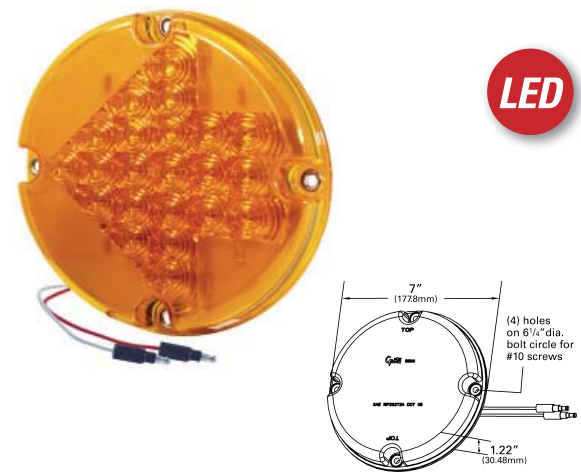

Stop / Tail / Turn Lamps

Feux Arrêt / Arrière / Direction Lámparas de Freno / Cuarto / Direccional

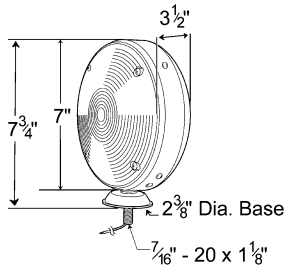

7" JUMBO DOUBLE-FACE PEDESTAL LAMP

For simultaneous front and rear warning • Pedestal mounting • Baked black enamel finish

TURN:

78150 Red and Yellow
78153 Yellow and Yellow

AUXILIARY:

78152 Red and Red

Material: Steel / Acrylic
FMVSS: 78150, 78153 - I, S
Finish: Black / Red / Yellow
Bulb: 1156, 32 CP Volts / Amps: 12V / 2.1A (I)
Pigtail: 68080
Lens: Red 90092, Yellow 90093

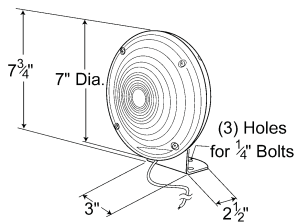

7" JUMBO SINGLE-FACE LAMP

Two-stud or bracket mounting • Heavy-gauge formed steel housing • Yellow arrow design for rear turn only • 78303 and 78313 not for front turn use

78002 Red
78003 Yellow
78303 Yellow, Arrow Lens, Molded .180 Terminal Pigtail
78313 Yellow, Arrow Lens, Blunt-Cut Pigtail

Material: Steel / Acrylic
FMVSS: Red - I, S; Yellow and Yellow Arrow - I; Arrow Lens - I
Finish: Black / Red / Yellow
Bulb: 1156, 32 CP Volts / Amps: 12V / 2.1A (I,S)
Bracket: 43282
Pigtail: 68080
Lens: Red 90092, Yellow 90093, Blue 90095, Arrow Lens - Yellow 90103

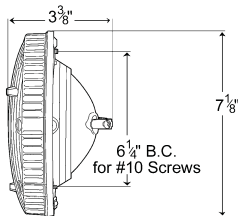

7" SCHOOL BUS LAMPS

Rugged housing • Acrylic lens • Flush mount • Blunt cut wires
• 4636 sealed beam (78832 and 78323)

SEALED BEAM:

78322 Red

SINGLE CONTACT:

56072 Red
56073 Yellow
56083 Yellow w / Arrow Lens

DOUBLE CONTACT:

50132 Red

Material: Steel / Acrylic
FMVSS: I, S, T, W, W2
Finish: Black / Red / Yellow
Bulb: 1157, 32 / 3 CP (X2) 50132 Volts / Amps: 12V 2.1A (I,S) / .59A (T) Double Contact
Bulb: 1156, 32 CP Volts / Amps: 12V / 2.1A (I,S) 56072, 56073, 56083 Single Contact
Bulb: 4636, Par 46, 90,000 CP 78322 Volts / Amps: 12V / 80-Watt (W,W2) Sealed Beam
Lens: Sealed Beam - Red 99832, Yellow 99833
Single / Double Contact - Red 99842, Yellow 99843
Rectangular Arrow Lens - Yellow 99863; Round Arrow Lens - Yellow 93433

RV, Marine and Utility Trailer Lighting

Phares Nautiques, de Véhicules Récréatifs et de Remorques Faros de Marina y Luces de Vehiculos Recreativos

71

RV, MARINE AND UTILITY TRAILER LIGHTING

SUPERNOVA® LED MAGNETIC TOWING KIT

Features SuperNova® LED lamps • Durable rubber housings • Strong 50 lb. pull mounting magnets for each lamp • Rubber adhesive magnet covers prevent scratching paint of towed vehicle • Adjustable lamp mounting for maximum visibility and safety • Die-cast 4-pole round plug • 30 ft. of abrasion-resistant jacketed cable

65432-4 Red

Material: Rubber / Polycarbonate / ABS / Acrylic
FMVSS: I, P2, S, T
Finish: Black / Red
Volts / Amps: 12V / .24A (I,S) / .03A (P2,T) per lamp
Accessory: Lamp: Red 54332; Magnetic Mount: 43300; Plug: 82-1021, Vehicle Socket: 82-1020



LED

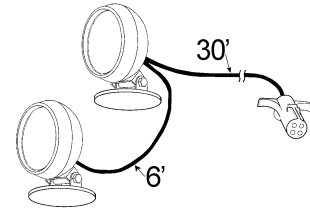

LED TOWING LIGHT KIT

Complete kit includes lamps, harness and hook-up connectors • Kit specifications include truck harness and 20 ft. connecting harness • Plugs into a standard flat four-way vehicle trailer light connector

65720-5 Red **new**

Material: ABS, Acrylic
FMVSS: I, P2, S, T
Finish: Black / Red
Volts / Amps: 12V / .25A (I, S) / .04A (P2, T)



LED

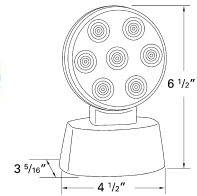

MAGNETIC TOWING LAMP KIT

Durable rubber lamp housings • Strong 50 lb. mounting magnets for each lamp • Rubber adhesive magnet covers to prevent scratching of towed vehicle • Sealed 4" stop / tail / turn combination lamps • Adjustable lamp mounting for maximum visibility and safety • Durable die-cast 4-pole plug • Abrasion-resistant, double-jacketed cable on all components

65402-4 Red

Material: Rubber, ABS
FMVSS: I, P2, S, T
Finish: Black / Red
Bulb: (2) 2057, 32 / 2 CP
Volts / Amps: 12V / .48A (P2,T) / 2.1A (I,S) per lamp
Accessory: Lamp: Red 52922, Magnetic Mount: 43300, Plug: 82-1021, Vehicle Socket: 82-1020

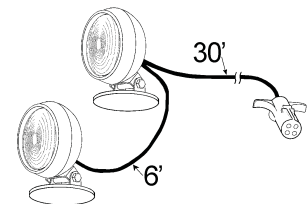

TOWING LAMP KIT

Complete kit includes harness, lamp and hook-up connectors • Kit specifications include truck harness and 20 ft. connecting harness • Plugs into a standard, flat four-way vehicle trailer light connector • Lens and bulb are replaceable

65730-5 Red **new**

Material: ABS, Acrylic
FMVSS: I, P2, S, T
Finish: Black / Red
Bulb: (2) 32 CP, 1157
Volts / Amps: 12V / 2.1A (I, S) / .59A (P2, T)
Lens: 90232

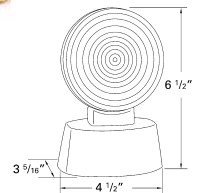

grote.com

71

RV, Marine and Utility Trailer Lighting

Phares Nautiques, de Véhicules Récréatifs et de Remorques Faros de Marina y Luces de Vehiculos Recreativos

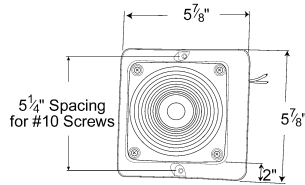

VERSALITE® SINGLE-POD SURFACE-MOUNT LAMP

Three functions: stop, tail, and turn • Surface mount • Corrosion-proof, shock-absorbent DURAMOLD® construction

51142 Red

Material: DURAMOLD® / Acrylic
 FMVSS: I, S, T
 Finish: White / Red
 Bulb: 1157, 32 / 3 CP Volts / Amps: 12V / 2.1A (I,S) / .59A (T)
 Lens: Red 90742

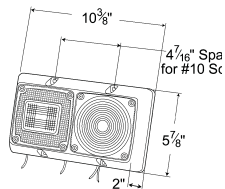

VERSALITE® DOUBLE-POD SURFACE-MOUNT LAMP

Five functions: stop, tail, turn, back-up light, and reflector • Surface mount • Corrosion-proof, shock-absorbent DURAMOLD® construction

51242 Red
51242-5 Red, Retail Pack

Material: DURAMOLD® / Acrylic
 FMVSS: A, I, R, S, T
 Finish: White / Red
 Bulb: 1157, 32 / 3 CP Volts / Amps: 12V / 2.1A (I, R, S) / .59A (T)
 Lens: Red 90742; Reflex - Red 90752

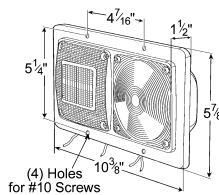

VERSALITE® DOUBLE POD RECESSED-MOUNT LAMP

Five functions: stop, tail, turn, back-up light, and reflector • Recessed mount • Corrosion-proof, shock-absorbent DURAMOLD® construction

51042 Red, Retail Pack

Material: DURAMOLD® / Acrylic
 FMVSS: A, I, R, S, T
 Finish: White / Red
 Bulb: S / T / T - 1157, 32 / 3 CP Volts / Amps: 12V / 4.2A (I, R, S) / .59A (T)
 Bulb: 1156, 32 CP Volts / Amps: 12V / .59A (T)
 Lens: Red 90742; Reflex - Red 90752

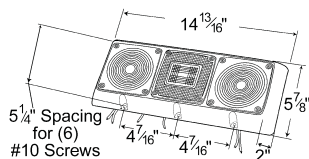

VERSALITE® TRIPLE POD SURFACE-MOUNT LAMP

Six functions: stop, tail, turn, clearance light, back-up light, and reflector • Surface mount • Corrosion-proof, shock-absorbent DURAMOLD® construction

51342-5 Red, Colonial White, Retail Pack
52082 Red, Chrome Finish, Retail Pack

Material: DURAMOLD® / Acrylic
 FMVSS: A, I, P2, R, S, T
 Finish: White / Chrome / Red
 Bulb: S / T / T - 1157, 32 / 3 CP
 Volts / Amps: 12V / 4.2A (I,S) / 1.18A (T)
 Bulb: 1156, 32 CP
 Volts / Amps: 12V / 1.18A (P2,T) / 4.2A (I,S) / 2.1A (R)
 Lens: Red 90742; Reflex - Red 90752

VERSALITE® TRIPLE-POD RECESSED-MOUNT LAMP

Six functions: stop, tail, turn, clearance light, back-up light, and reflector • Recessed mount • Corrosion-proof, shock-absorbent DURAMOLD® construction

52002 Red, Chrome Finish, Retail Pack

Material: DURAMOLD® / Acrylic
 FMVSS: A, I, P2, R, S, T
 Finish: Chrome / White / Red
 Bulb: S / T / T - 1157, 32 / 3 CP Volts / Amps: 12V / 4.2A (I,S) / 2.1A (R) / 1.18A (P2,T)
 Bulb: 1156, 32 CP Volts / Amps: 12V / .59A (T)
 Lens: Red 90742, Yellow 90743, Reflex - Red 90752

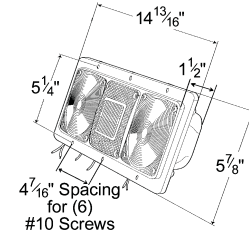
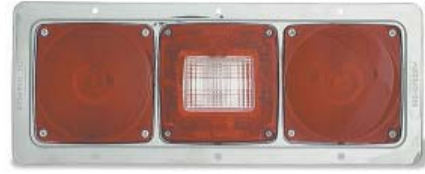

VERSALITE® TRIPLE-POD RECESSED-MOUNT LAMP WITH YELLOW TURN LENS

Five functions: stop, tail, turn signal, back-up light, and reflector • Recessed mount • Corrosion-proof, shock-absorbent DURAMOLD® construction

52112 Retail Pack, LH
52122 Retail Pack, RH

Material: DURAMOLD® / Acrylic
 FMVSS: A, I, P2, R, S, T
 Finish: Chrome
 Bulb: 1157, 32 / 3 CP Volts / Amps: 12V / 4.2A (I,S) / 2.1A (R) / 1.18A (T)
 Bulb: 1156, 32 CP Volts / Amps: 12V / .59A (T)
 Lens: Red 90742, Yellow 90743; Reflex - Red 90752

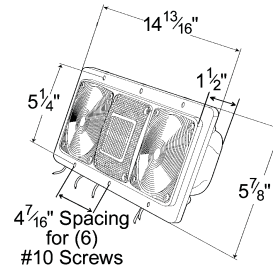

ECONOMY TAILGATE AND RUNNING BOARD LIGHTING KIT

Easy-to-mount lamp features a snap-on lens and mounting-screw ground
 • Kit comes complete with 6 lamps, wiring, and instructions • Ideal option for cost-conscious customers who want to customize their truck, trailer, pickup, RV or SUV

65092-5 Red, Retail Pack
65093-5 Yellow, Retail Pack

Material: DURAMOLD® / Acrylic
 FMVSS: P2, P3
 Finish: White / Red / Yellow
 Bulb: 194, 2 CP Volts / Amps: 12V / .27A per lamp
 Accessory: Lamp: Red 46882, Yellow 46883
 Lens: Red 92432, Yellow 92433

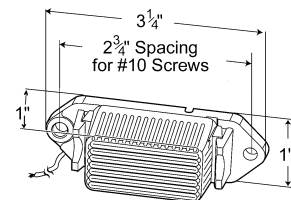

RV, Marine and Utility Trailer Lighting

Phares Nautiques, de Véhicules Récréatifs et de Remorques Faros de Marina y Luces de Vehiculos Recreativos

LED



ULTIMATE LED TRAILER LIGHT KIT

• Easily retrofits any 14' to 28' boat trailer • Maintenance- and hassle-free • Water-proof • Rear combination clearance / marker must be mounted at a 45° angle

65410-5 Complete Lighting, Wiring Kit, Retail Pack **new**

- (1) 60341 Black; FMVSS: L; Volts / Amps: 12V / .04A
- (1) 43272 Black / Steel
- (1) 49182 Black / Red / Polycarbonate; FMVSS: P2; Volts / Amps: 12V / .18A
- (1) 6604D7 Harness
- (2) 47972 / 47973 Red / Yellow / Polycarbonate / ABS; FMVSS: PC; Volts / Amps: 12V / .05A
- (2) 41153 Yellow; FMVSS: A
- (2) 43362 Black / Steel
- (2) 92420 Black / PVC
- (2) 53962 Red / ABS / Acrylic; FMVSS: I6, P, S, T, P2; Volts / Amp: 12V / .48A (I, S) .04 (P2, T)
- (4) 41152 Red; FMVSS: A

LED



SUPERNOVA® OVAL BOAT TRAILER STOP /TAIL /TURN SUBMERSIBLE LIGHTING KIT

Available in Grote OEM male-pin retrofit or replacement • Electronics completely encapsulated with durable epoxy for maximum protection from the environment • Fits current mounting flanges and grommets • Kit includes two each of: LED lamps (54132), brackets (43362), grommets (92420) and 3-wire, 11" plug-in pigtails (67002); Easy to install brackets • Submersible stop / tail / turn lamps are ideal for trailers

65390-5 Red, Retail Pack

Material: ABS / Acrylic
 FMVSS: I, S, T
 Finish: Black / Red
 Volts / Amps: 12V / .48A (I,S) / .06A (P2,T) per lamp
 Accessory: Lamp: Red 53962
 Bracket: 43362
 Grommet: 92420
 Pigtail: 67002

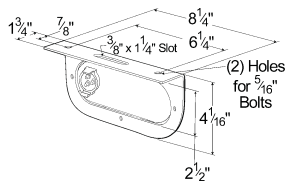

OVAL STOP /TAIL /TURN SUBMERSIBLE TRAILER LIGHTING KIT

Submersible stop / tail / turn lamps, ideal for boat trailers • Easy-to-install brackets • Kit includes two of each: lamps (52182), brackets (43362), grommets (92420) and 3-wire 11" plug-in pigtails (67000)

53082-5 Red, Retail Pack

Material: Steel / Polycarbonate
 FMVSS: I, S, T
 Finish: Black / Red
 Bulb: 32 / 3 CP Volts / Amps: 12V / 2.1A (I,S) / .59A (T) per lamp
 Accessory: Lamp: Red 52182
 Bracket: 43362
 Grommet: 92420
 Pigtail: 67000

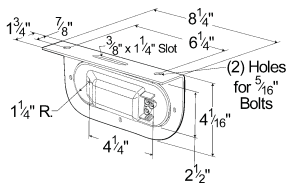

SUBMERSIBLE LED TRAILER LIGHTING KIT

Popular square design • 7-function stop / tail / turn lamps • LEDs provide increased stopping distance for trailing motorists • Kits include lamps, trailer harness, license bracket and mounting hardware

- 65330-5** w / Clearance / Marker, Retail Pack
- 65320-5** w / o Clearance / Marker, Retail Pack

REPLACEMENT LAMP:

- 51982** Red, RH, S / T / T
- 51982-5** Red, RH, S / T / T, Retail Pack
- 51992** Red, LH, S / T / T
- 51992-5** Red, LH, S / T / T, Retail Pack
- 47852-5** Red, Sidemarker, Retail Pack
- 47853-5** Yellow, Sidemarker, Retail Pack

Material: DURAMOLD®
 FMVSS: RH - A, I, P2, S, T, LH - A, I, L, P2, S, T, C / M - P2
 Finish: Black / Red
 Volts / Amps: S / T / T - 12V / .22A
 Volts / Amps: C / M - 12V / .11A
 Bracket: 43262-5
 Lens: S / T / T - Red 90642; Clearance / Marker - Red 91372, Yellow 91373

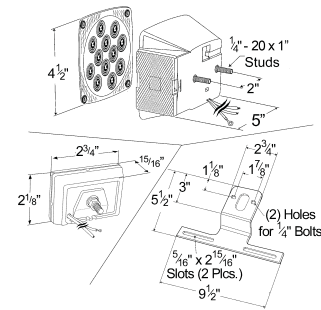

SUBMERSIBLE TRAILER LIGHTING KIT

Popular square design • Kit includes harness, lamps, license bracket and mounting hardware

- 65230-5** w / Clearance / Marker, Retail Pack

REPLACEMENT PARTS:

- 53662** Red, RH, S / T / T
- 53672** Red, LH, S / T / T
- 46982-5** Red, Clearance / Marker, Retail Pack
- 46983-5** Yellow, Clearance / Marker, Retail Pack
- 90172** Red, S / T / T Lens Kit (90642 and 91112)

Material: DURAMOLD®
 FMVSS: RH - A, I, P2, S, T, LH - A, I, L, P2, S, T, C / M - P2
 Finish: Black
 Bulb: S / T / T - 1157, 194 Volts / Amps: 12V / .21A (I, S) / .59A (T) per lamp
 Bulb: C / M - 1895, 2 CP Volts / Amps: 12V / .27A (P2) per lamp
 Lens: S / T / T - Red 90642
 Sidemarker and Clearance / Marker, Screw-on - Red 91112, Yellow 91153

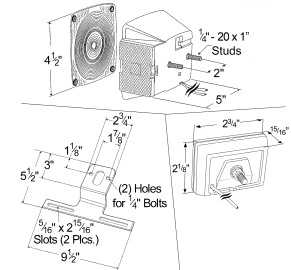

SUBMERSIBLE LOW-PROFILE LED TRAILER LIGHTING KIT

Rated to 100,000 hours of service • Designed especially to fit EZ Loader® Trailers • Ideal for trailer lighting upgrades on older trailers

- 65560-5** Red, Kit, Retail Pack

REPLACEMENT LAMP:

- 52652-5** Red, RH, S / T / T, Retail Pack
- 52742-5** Red, LH, S / T / T w / License Window, Retail Pack
- 49242-5** Red, ID Bar Lamp, Retail Pack

Material: DURAMOLD®
 FMVSS: RH - A, I, P2, S, T; LH - A, I, L, P2, S, T; C / M - P2
 Finish: Black / Red
 Volts / Amps: S / T / T - 12V / .22A
 Volts / Amps: ID - 12V / .11 A

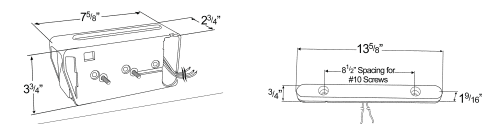

RV, Marine and Utility Trailer Lighting

Phares Nautiques, de Véhicules Récréatifs et de Remorques Faros de Marina y Luces de Vehiculos Recreativos

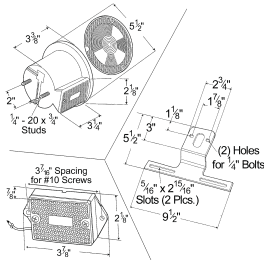

TRAILER LIGHTING KIT WITH FRONT SIDEMARKER LAMP

7-function tail lamps: stop / tail / turn, side / rear reflector sidemarker and license lamp • Kit includes right and left tail lamps (50532, 50542), two clearance / marker lamps (46393), 4-foot trunk and 25-foot split-Y trailer harnesses, license bracket (43262-5), mounting hardware

65350-5 Boat Trailer Kit, w / Clearance / Marker, Retail Pack

65190-5 Boat Trailer Kit, w / o Clearance, Retail Pack

REPLACEMENT LAMP:

50542 Red, RH

50542-5 Red, RH, Retail Pack

50532 Red, LH w / License Window

50532-5 Red, LH w / License Window, Retail Pack

46393-5 Yellow, Side Marker, Retail Pack

Material: DURAMOLD® / Acrylic

FMVSS: RH - A, I, L P2, S, T; LH - A, I, P2, S, T, C / M A, P2, P3

Finish: Black / Red

Bulb: S / T / T - 1157, 32 / 3 CP Volts / Amps: 12V / 2.1A (I, S) / .59A (T)

Bulb: Sidemarker - 1895, 2 CP Volts / Amps: 12V / .59A (T, L, P2)

Bulb: C / M - 1895, 2 CP Volts / Amps: 12V / .27A (P2)

Lens: Screw-on Tail Marker Red 91152, Yellow 91153

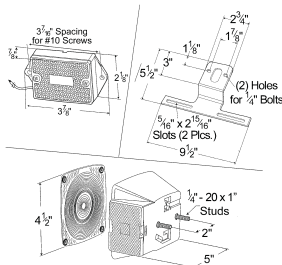

UTILITY TRAILER, LIGHTING KIT

Replaces Peterson® 440 Boat Lamp kit • Twist-in bulb design makes it easy to replace • Kit includes harness, license plate bracket, instructions and complete wiring and installation kit

65370-5 w / Clearance / Marker, Retail Pack

65380-5 w / o Clearance / Marker, Retail Pack

REPLACEMENT PARTS:

52302 Red, RH, S / T / T

52302-5 Red, RH, S / T / T, Retail Pack

52312 Red, LH, S / T / T

52312-5 Red, LH, S / T / T, Retail Pack

46982-5 Red, Clearance / Marker, Retail Pack

46983-5 Yellow, Clearance / Marker, Retail Pack

Material: DURAMOLD® / Acrylic

FMVSS: A, I, L, P2, S, T

Finish: Black / Red

Bulb: S / T / T - 1157, 32 / 3 CP Volts / Amps: 12 V - 2.1(I,S) / .59(T) A

Bulb: Marker - 1895, 2 CP Volts / Amps: 12 V - .27(P2) A

Lens: S / T / T - Red 92792; Sidemarker and Clearance / Marker,

Screw-on Red 91152, Yellow 91153

UTILITY LIGHTING KIT FOR TRAILERS OVER 80" WIDE

Twist-in bulb design makes maintenance easy • Kit includes harness, license plate bracket, instructions and complete wiring / installation kit

65240-5 Combination S / T / T and Sidemarker w / o ID Cluster and Front C / M, Retail Pack

REPLACEMENT PARTS:

52442 Red, RH, S / T / T and Sidemarker
52452 Red, LH, S / T / T w / License Window and Sidemarker

Material: DURAMOLD® / Acrylic
 FMVSS: RH - A, I, P2, P3, S, T; LH - A, I, L, P2, P3, S, T
 Finish: Black / Red
 Bulb: S / T / T - 1157, 168 CP Volts / Amps: 12V / .27A (P2)
 Bulb: C / M - 1895, 2 CP
 Bracket: 43262-5
 Lens: S / T / T - Red 92792; Sidemarker - Red 91122

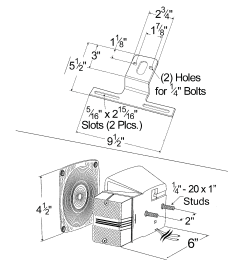

SUBMERSIBLE TRAILER LIGHTING KIT FOR TRAILERS OVER 80" WIDE

Popular square design • Kit includes harness, lamps, license bracket and mounting hardware

TRAILERS OVER 80" KIT:

65440-5 Combination S / T / T and Sidemarker w / o Cluster and Front C / M, Retail Pack

REPLACEMENT PARTS:

51932 Red, RH, S / T / T and Sidemarker
51942 Red, LH, S / T / T w / License Window and Sidemarker
94210 Gasket

Material: DURAMOLD®
 FMVSS: S / T / T RH - A, I, P2, S, T; S / T / T LH - A, I, L, S, T
 Finish: Black / Red
 Bulb: 1157, 168 CP Volts / Amps: 12V / .59A
 Accessory: Harness: 68420
 Bracket: 43262-5
 Lens: S / T / T - Red 90642; Sidemarker - Red 91122

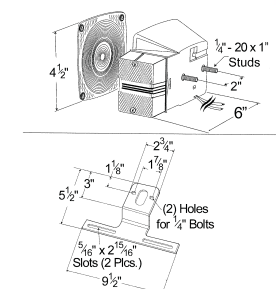

RV, Marine and Utility Trailer Lighting

Phares Nautiques, de Véhicules Récréatifs et de Remorques Faros de Marina y Luces de Vehiculos Recreativos

LED



SUBMERSIBLE LOW-PROFILE LED TRAILER LIGHT KIT FOR TRAILERS OVER 80" WIDE

Rated to 100,000 hours of service • Designed specifically to fit EZ Loader* trailers • Kit does not include rear clearance lamp

65570-5 Red, Kit w/ o Clearance / Marker, Retail Pack

REPLACEMENT PARTS:

52712-5 Red, RH, S / T / T, Retail Pack

52722-5 Red, LH, S / T / T, Retail Pack

49242-5 Red, ID Bar, Retail Pack

Material: DURAMOLD®

FMVSS: S / T / T RH- A, I, P2, S, T; S / T / T LH- A, I, L, P2, S, T; C / M- P2

Finish: Black / Red

Volts / Amps: S / T / T - 12V / .28A

Volts / Amps: ID - 12V / .11A

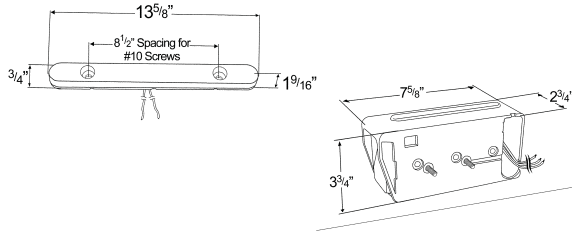

SUBMERSIBLE COMPACT TRAILER LIGHTING KIT

Unique compact size and shape to fit where space is limited • Sonically-sealed makes lamp fully submersible • Pre-wired with molded plugs for easy installation • Kit includes two lamps, a 25' trailer harness, connector and license bracket

65312 Red, Pair Pack, Retail Pack

REPLACEMENT LAMP:

53812 Red, RH, S / T / T, w / License Window

53822 Red, LH, S / T / T, w / License Window

Material: DURAMOLD®

FMVSS: A, I, P2, S, T

Finish: Black / Red

Bulb: 1157, 32 / 2 CP Volts / Amps: 12V / 2.1A (I, S0 / .59(T)

Bulb: 194, 2 CP Volts / Amps: 12V / .27A (P2,T)

Bracket: 43262-5

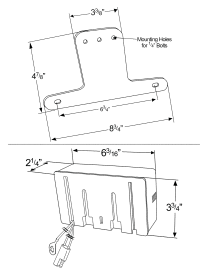

SUBMERSIBLE LOW-PROFILE RECTANGULAR TRAILER LIGHTING KIT

Unique compact size fits where space is limited • Lens is sonically sealed to make a fully submersible lamp

65300-5 Red, Pair Pack, Retail Pack

52492 Red, LH, S / T / T w / License Window

52482 Red, RH, S / T / T

90652 Lens Kit (2 S / T / T and 2 Side Markers)

Material: DURAMOLD®

FMVSS: RH - A, I, S, T, LH - A, I, L, S, T

Finish: Black

Volts / Amps: 12V / 2.1A / .48A

Accessory: Bulb: 90630

Bracket: 43262-5

Lens: Red (kit-front and side) 90652

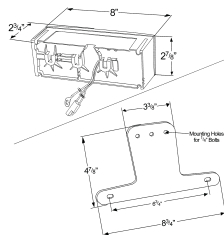

TRAILER TONGUE-MOUNT CLEARANCE / MARKER LED LAMPS

Single LED lamp • Rated to 100,000 hours of service • Snap-on lens • Hard wired

45273-5 Yellow

Material: Acrylic
FMVSS: A, P2, P3
Finish: Yellow / Black
Volts / Amps: 12V / .025A
Lens: 93923

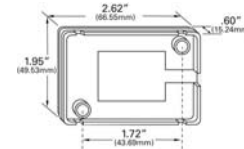

LARGE, SQUARE CLEARANCE / MARKER LAMPS

Mount on trailers over 80" for use as combined sidemarker and clearance light with reflector • Easily mounts with single stud

46442-5 Red, Retail Pack

46443-5 Yellow, Retail Pack

Material: Acrylic
FMVSS: A, P2, P3
Finish: Yellow / Black
Bulb: 168, 3 CP Volts / Amps: 12V / .35A

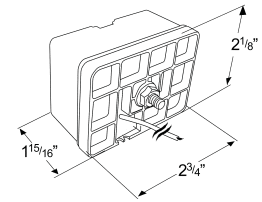

WATERPROOF COMBINATION CLEARANCE / MARKER LAMP WITH REFLECTOR

Sonically sealed lens protects lamp from moisture • Built-in reflector • Legal on trailers over 80" in width • Surface mounts with attached pigtail

47863 Yellow

Material: Acrylic
FMVSS: A, PC
Finish: Yellow / Black
Bulb: 194, 2 CP Volts / Amps: 12V / .27A

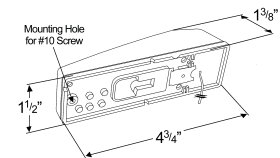

5-IN-1 COMBINATION REAR LAMP

For recreational vehicles and mobile homes • Combination lamp with stop, tail, turn, reflector and license functions • Flat-back, corrosion-proof, shock-absorbent DURAMOLD® base • 180° full lens illumination

50762 Red

Material: DURAMOLD® / Acrylic
FMVSS: A, I, L, S, T
Finish: Red / White
Bulb: 1157, 32 / 3 CP Volts / Amps: 12V / 2.1A (I,S) / .59A (L, T)
Pigtail: 68150
Lens: Red 90602

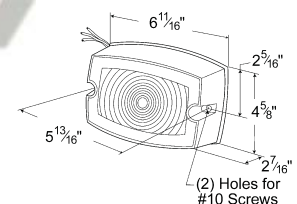

RV, Marine and Utility Trailer Lighting

Phares Nautiques, de Véhicules Récréatifs et de Remorques Faros de Marina y Luces de Vehiculos Recreativos

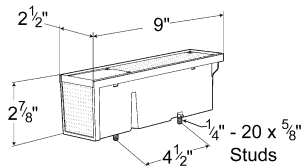

LARGE WRAP-AROUND 5-IN-1 TAIL LAMP

For utility and snowmobile trailers • 5-in-1 functions: stop, tail, turn, sidemarker and reflector

52372 RH
52362 LH

Material: DURAMOLD® / Acrylic

FMVSS: A, I, P2, S, T

Finish: Re / White

Bulb: 1157, 32 / 3 CP Volts / Amps: 12V / .59A (T) / .27A (P2)

Bulb: 1895, 2 CP Volts / Amps: 12V / 2.1A (I,S)

Lens: Kit - Red 92382



TRAILER WIRING FRAME CLIP

Tinnerman clip • Holds wire harness to frame and trailer

99460-5 10 Pack, Retail Pack

Material: Spring Steel

Finish: Black



25' SPLIT-WIRE HARNESS

4-wire, split-Y trailer harness with male connector

68420 Wire Harness



25' HARNESS WITH MALE-FEMALE TERMINATION

4-Wire harness terminated with male on one end and female on the other

68520 Wire Harness



BOAT AND UTILITY TRAILER WIRING KIT

For durable re-wiring of boat, bike, snowmobile, or utility trailers

• A complete wire-harness package: 25' trailer harness, 4' trunk harness and (6) no-splice connectors

68540-5 Retail Pack

SUPERNOVA® LED LICENSE LAMP

Low-profile shape helps prevent damage from dock collisions • Vibration-resistant lamp is ideal for dump trucks, refuse haulers and cement mixers

- Slotted mounting holes fit most lamp mounting screw patterns and withstand excessive torque without cracking
- Not polarity-sensitive
- Encapsulant potting for total circuit-board protection

- 60381** Gray
- 60341** Black

Material: Polycarbonate
 FMVSS: L
 Finish: Gray / Black
 Volts / Amps: 12V / .04A

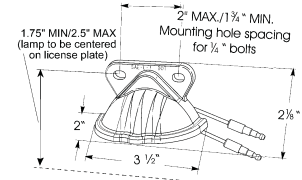

SMALL RECTANGULAR LED LICENSE LAMP

Hermetically sealed lamp prevents water intrusion • Hard-wired with .180 slim-line UBS plug connections for maximum performance • Indexed, snap-fit mounting to brackets

- 60601** Clear, White Body **new**
- 65790** Gray, Kit (60601 + 43960) **new**
- 65782** Black, Kit (60601 + 42162) **new**

Material: Polycarbonate
 FMVSS: L
 Finish: Clear
 Volts / Amps: 12V / .033A
 Bracket: 42162, 43960, 43962

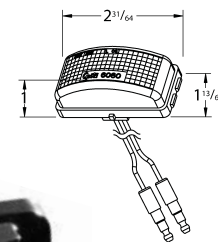

65782

RECTANGULAR LICENSE LAMP WITH BRACKET

Aluminum lamp bracket and stainless-steel license-plate bracket

- Complete assembly includes dual-function bracket, license lamp (60291), lamp bracket (43390) and 48", 14 gauge .180-bullet UBS pigtail
- License bracket not sold separately

- 60321** Clear w / Stainless-Steel Bracket

Material: Aluminum / Stainless-Steel / Polycarbonate
 FMVSS: L
 Finish: Aluminum
 Bulb: 193 (2) 2 CP Volts / Amps: 12V / .66A

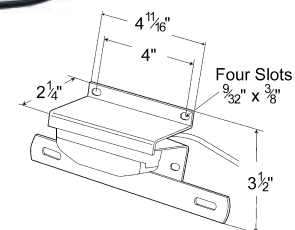

License and Backup

Feux de Plaque d'Immatriculation et de Recul Lámparas de Placa / Reversa

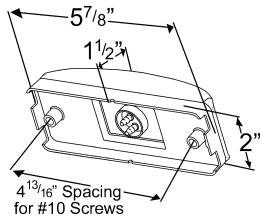

SEALED TURTLEBACK® II LICENSE LAMP

Impact-resistant bulb contacts • Waterproof male-pin connection accepts UBS pigtail • Used on Utility Trailers

60331 Clear

Material: Polycarbonate
FMVSS: L
Finish: White
Bulb: 193 (2) 2 CP Volts / Amps: 12V / .66A
Pigtail: 66910, 66911, 67070, 67071

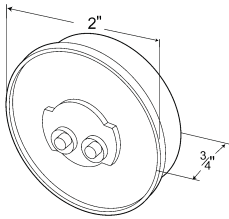

2" TWIST-IN FACTORY-SEALED LICENSE LAMP

Integral lamp hood and mounting receptacle • Twist-on mounting
• Accepts UBS pigtail

45821 Clear

KITS:

60191 Clear (45821 + 43040)

60021 Clear (45821 + 43040 + 67050)

Material: Polycarbonate
FMVSS: L when used with 43040 bracket
Finish: White / Clear
Bulb: 2 CP Volts / Amps: 12V / .33A
Bracket: 43040
Pigtail: 66850, 66851, 66800, 66840, 67001, 67050, 66801

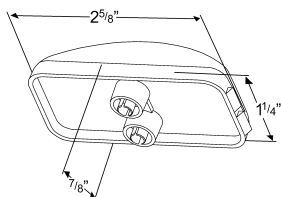

SMALL RECTANGULAR LICENSE LAMP

Sonically welded lens • Single 15,000-hour bulb

LICENSE LAMPS:

60261 Clear

LICENSE LAMP KITS:

60280 Clear (60261 + 43830)

60460 Clear Lamp, Gray Flange (60261 + 43960)

Material: ABS / Polycarbonate
FMVSS: L
Finish: Gray
Bulb: 193 2 CP Volts / Amps: 12V / .33A
Bracket: 43830, 43960, 42160, 43962, 42162
Grommet: 92520
Pigtail: 66850, 67050, 67001, 66851, 66800, 66840

RECTANGULAR LICENSE LAMP

Sonically sealed rectangular double-bulb lamp • Narrow mounting applications • 15,000-hour bulbs

60291 Clear

Material: Polycarbonate
 FMVSS: L
 Finish: Clear
 Bulb: 193 (2) 2 CP Volts / Amps: 12V / .66A
 Bracket: 43780, 43782, 43783
 Pigtail: 66980, 66981, 66982

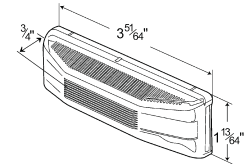

DURAMOLD® LICENSE LAMP

Compact license lamp protrudes less than 2" • Durable lens • Housing snaps firmly into molded O-ring

60001 Gray
60011 Triple-Chrome
60011-5 Triple-Chrome, Retail Pack

KITS:

60121 Gray w / UBS .180-Bullet UBS Plug-In Pigtail

PROTECTIVE LENS CAP:

93610 Gray

Material: ABS / Polycarbonate
 FMVSS: L
 Finish: Gray / Chrome
 Bulb: 67, 4 CP Volts / Amps: 12 V - .59 A
 Accessory: Gray Cap: 93610

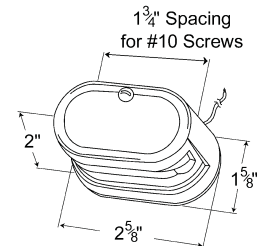

LICENSE LAMP WITH METAL BRACKET

Compact license lamp protrudes less than 2" • Housing snaps firmly into molded-in O-ring • Uses 60001 license lamp with 36" pigtail

60081 Clear

Material: Steel / Polycarbonate
 FMVSS: L
 Finish: Black / Gray
 Bulb: 67, 4 CP Volts / Amps: 12V / .59A

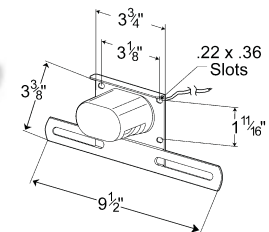

VERSALITE® LICENSE LAMP WITH BRACKET

Corrosion-proof, shock-absorbent ABS construction

60131 Clear

Material: ABS
 FMVSS: L
 Finish: White
 Bulb: 67, 4 CP Volts / Amps: 12V / .59A

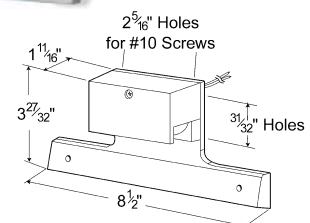

License and Backup

Feux de Plaque d'Immatriculation et de Recul Lámparas de Placa / Reversa

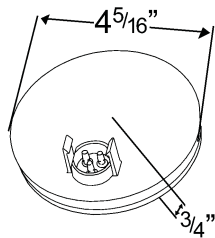
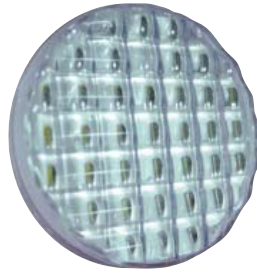

SUPERNOVA® 4" SINGLE-SYSTEM LED BACKUP LAMP

Meets backup function for single-lamp system • Encapsulant potting for total circuit-board protection • Advanced pin connection system uses tin-plated, solid-brass pin terminals • Uses same UBS pigtail as male-pin incandescent • Hard-coated lens for long-term UV protection

MALE-PIN:

- 62401** Clear, Grommet Mount
- 62671** Clear w / Stainless-Steel, Theft-Resistant Flange
- 62541** Clear, Grommet Mount 24-Volt new

HARD-WIRED:

- 62511** Clear, Grommet Mount

Material: Polycarbonate
 FMVSS: R
 Finish: Clear
 Volts / Amps: 12V / .6A
 Bracket: 43343, 92510, 92512, 92513, 43253
 Grommet: 91740, 91950 Pigtail: 66842, 67013, 67016, 66846

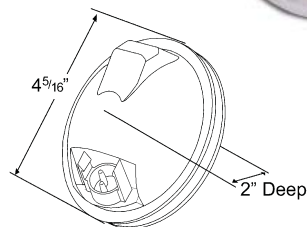

4" TORSION MOUNT® II MALE-PIN SINGLE-SYSTEM BACKUP LAMP

Torsion Mount® II Gel-Mount® bulb cradle design • Locking tabs ensure solid pigtail connection • Meets backup function for single-lamp system • Hermetic lens-to-housing seal

- 62211** Clear

KITS:

- 62221** Clear (61451 + 91740 + 67013)

Material: Polycarbonate
 FMVSS: R
 Finish: Gray
 Bulb: 2057 32 / 2 CP Volts / Amps: 12V / 2.1A
 Bracket: 43572, 43253, 92510, 92512, 92513
 Grommet: 91740, 91950
 Pigtail: 67013, 66842, 66846, 67016

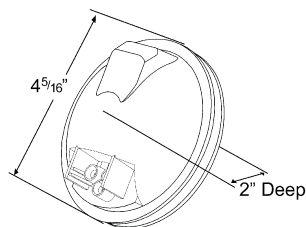

4" TORSION MOUNT® II SINGLE-SYSTEM BACKUP LAMP

Torsion Mount® II Gel-Mount® bulb cradle design • Hermetic lens-to-housing seal • Polycarbonate lens and body • Meets backup function for single-lamp system

- 62271** Clear

KITS:

- 62331** Clear (62271 + 91740 + 67010)

Material: Polycarbonate
 FMVSS: R
 Finish: Clear
 Bulb: 2057 32 CP Volts / Amps: 12V / 2.1A
 Bracket: 43572, 43253, 92510, 92512, 92513
 Grommet: 91740, 91950
 Pigtail: 67011, 67010, 67012, 67015, 67014, 67020

4" ECONOMY SINGLE-SYSTEM BACKUP LAMP

Meets backup function for single-lamp system • Standard female connection • Hermetic lens-to-housing seal • Fits all competitive grommets and brackets

62431 Clear

KITS:
62451 Clear (62431 + 91740 + 67010) **new**

Material: Polycarbonate
FMVSS: R
Finish: Clear
Bulb: 2057 32 CP Volts / Amps: 12V / 2.1A
Bracket: 43572, 92150, 92510, 92513, 43253
Grommet: 91740, 91950 Pigtail: 67011, 67010, 67014, 67020

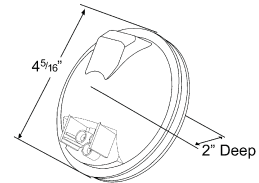

SUPERNOVA® 4" DUAL-SYSTEM LED BACKUP LAMP

Requires two lamps to meet backup function • Encapsulant potting for total circuit-board protection • Advanced pin connection system uses tin-plated, solid-brass terminations • Uses same UBS pigtail as male incandescent • Hard-coated lens for long-term UV protection

62391 Clear

62571 Clear, 24-Volt **new**

Material: Polycarbonate
FMVSS: (2)R
Finish: Clear
Volts / Amps: 12V / .25A; 24V - .15A
Bracket: 43343, 92510, 92512, 92513, 43253
Grommet: 91740, 91950 Pigtail: 66842, 67013, 67016, 66846

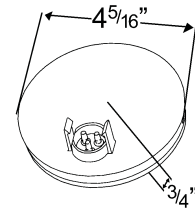

SUPERNOVA® NEXGEN™ 4" DUAL-SYSTEM LED BACKUP LAMP

Fits standard 4" lamp grommets and brackets • Hermetically sealed lamp prevents water intrusion • Requires two lamps to meet backup function • Encapsulant potting for total circuit-board protection

62091 Clear, Male-Pin **new**

62101 Clear, Hard-Shell **new**

Material: ABS / Acrylic
FMVSS: (2)R
Finish: Clear
Volts / Amps: 12V / .55A
Bracket: 93552, 43253, 92510, 92511, 92513, 43572, 43642, 43655, 43732, 93190, 93550, 93553, 93683, 51090 Grommet: 91740, 91950 Pigtail: 67013, 66816, 66845, 67005, 66823, 66830, 67016, 66846, 66836, 67006, 66862, 66812, 66811

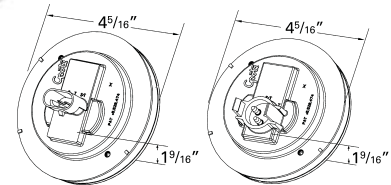

GROTE SELECT™ 4" DUAL-SYSTEM LED BACKUP LAMP

Fits standard 4" lamp grommets and brackets • Hermetically sealed lamp prevents water intrusion • Requires two lamps to meet backup function • Aftermarket connection

62691 Female-Pin **new**

Material: ABS / Acrylic
FMVSS: (2)R
Finish: Clear
Volts / Amps: 12V - .55A
Bracket: 93552, 43253, 92510, 92511, 92512, 92513, 43572, 43642, 43655, 43732, 93190, 93550, 93553, 93683, 51090 Grommet: 91740, 91950 Pigtail: 67013, 66816, 66845, 67005, 66823, 66830, 67016, 66846, 66836, 67006, 66862, 66812, 66811

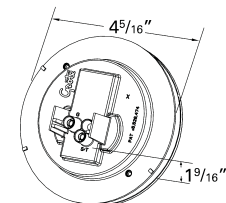

License and Backup

Feux de Plaque d'Immatriculation et de Recul

Lámparas de Placa / Reversa

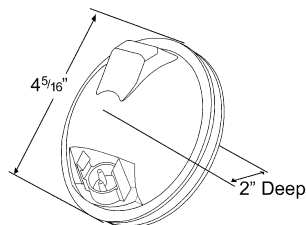

4" TORSION MOUNT® II MALE-PIN DUAL-SYSTEM BACKUP LAMP

Requires two lamps to meet backup function • Torsion Mount® II Gel-Mount® bulb cradle design • Locking tabs ensure solid pigtail connection • Kit includes lamp, grommet (91740) and pigtail (67002) • Hermetic lens-to-housing seal

62121 Frosted Clear

KITS:

62131 Frosted Clear (62121 + 91740 + 67002)

Material: Polycarbonate
FMVSS: (2)R
Finish: Frosted
Bulb: 2057 32 CP Volts / Amps: 12V / 2.1A
Bracket: 43572, 43253, 92510, 92512, 92513
Grommet: 91740, 91950
Pigtail: 66842, 67013, 66846, 67016, 67002

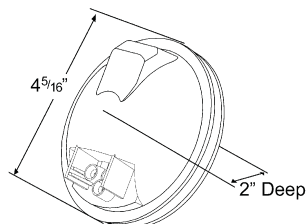

4" TORSION MOUNT® II DUAL-SYSTEM BACKUP LAMP

Requires two lamps to meet backup function • Torsion Mount® II Gel-Mount® bulb cradle design • Hermetic lens-to-housing seal • External use only

62171 Frosted Clear

62321 Frosted Clear, 24-Volt

62720 Frosted Clear, Clear Housing **new**

KITS

62181 Clear, Backup Lamp (62171 + 91740 + 67010)

Material: Polycarbonate
FMVSS: (2)R
Finish: Frosted
Bulb: 2057 32 CP Volts / Amps: 12V / 2.1A
Volts / Amps: 24V / 1.05A
Bracket: 43572, 43253, 92510, 92512, 92513
Grommet: 91740, 91950
Pigtail: 67010, 67014, 67011, 67020

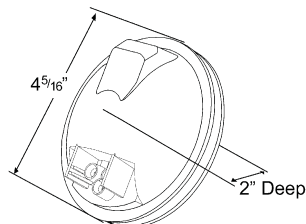

4" ECONOMY DUAL-SYSTEM BACKUP LAMP

Requires two lamps to meet backup function • Standard female-pin • Hermetic lens-to-housing seal • Fits all competitive pigtails, grommets, and brackets

62421 Frosted Clear

Material: Polycarbonate
FMVSS: (2)R
Finish: Cream
Bulb: 2057 32 CP Volts / Amps: 12V / 2.1A
Volts / Amps: 12V
Bracket: 43572, 43253, 92510, 92512, 92513
Grommet: 91740, 91950
Pigtail: 67011, 67010, 67014, 67020

SUPERNOVA® OVAL SINGLE-SYSTEM LED BACKUP LAMPS

Legal for horizontal mount only • Male-pin for plug and go installation
 • Retrofit upgrade for original equipment Volvo* trucks using the Grote tail lamp system
 • Encapsulant potting for total circuit-board protection

62561 Clear, Grommet Mount **new**

Material: ABS / Acrylic
 FMVSS: R
 Finish: Clear
 Volts / Amps: 12V / .30A
 Bracket: 43362, 43952, 43220, 43223, 43222, 43723, 43100
 Grommet: 92420, 92720 Pigtail: 66815, 66841, 67002, 66842, 67013

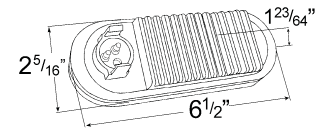

TORSION MOUNT® III OVAL MALE-PIN SINGLE-SYSTEM BACKUP LAMP

Fits standard oval lamp grommets and brackets • Torsion Mount® III, Gel Mount® bulb cradle technology increases bulb life due to vibration damage
 • Male-pin UBS® connection technology utilizes O-ring seals and pigtail locking tabs to help eliminate the threat of corrosion from water intrusion
 • Meets backup function for single-lamp system

62111 Frosted Clear Lens **new**

Material: Polycarbonate
 FMVSS: R
 Finish: Frosted Clear
 Bulb: 2357 40 CP Volts / Amps: 12V / 2.2A
 Bracket: 43362, , 43952, 43220, 43222,, 43223
 Grommet: 92420, 92720 Pigtail: 66842, 67013, 66846, 67016

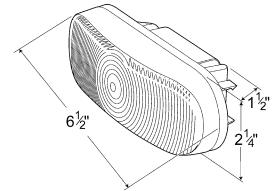

SUPERNOVA® OVAL DUAL-SYSTEM LED BACKUP LAMPS

Requires two lamps to meet backup function • Encapsulant potting for total circuit-board protection • Uses same UBS pigtail as male-pin incandescent

MALE-PIN, HORIZONTAL MOUNT:

62601 Clear, Grommet Mount

MALE-PIN, VERTICAL MOUNT:

62591 Clear, Grommet Mount

Material: ABS / Acrylic
 FMVSS: (2)R
 Finish: Clear
 Volts / Amps: 12 V / .30 A
 Bracket: 43362, 43952, 43220, 43223, 43222, 43723, 43100
 Grommet: 92420, 92720 Pigtail: 66815, 66841, 67002, 66842, 67013

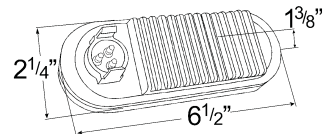

SUPERNOVA® NEXGEN™ OVAL DUAL-SYSTEM LED BACKUP LAMPS

Fits standard oval lamp grommets and brackets • Hermetically sealed lamp prevents water intrusion • Requires two lamps to meet backup function
 • Lamps must be mounted vertically • Encapsulant potting for total circuit-board protection

62051 Male-Pin **new**
62061 Hard-Shell **new**
62761 Hard-Wired **new**

Material: ABS / Acrylic
 FMVSS: (2)R
 Finish: Clear
 Volts / Amps: 12V / .30 A
 Bracket: 43362, 43952, 43220, 43223, 43222, 43723, 43100
 Grommet: 92420, 92720 Pigtail: 67013, 66861, 66862, 66842, 66846, 67016

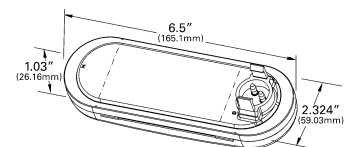

License and Backup

Feux de Plaque d'Immatriculation et de Recul Lámparas de Placa / Reversa

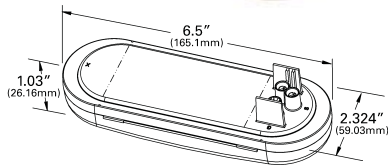

GROTE SELECT™ OVAL DUAL-SYSTEM LED BACKUP LAMP

Fits standard oval lamp grommets and brackets • Hermetically sealed lamp prevents water intrusion • Requires two lamps to meet backup function
• Lamps must be mounted vertically • Aftermarket connection

62751 Female-Pin **new**

Material: ABS / Acrylic
FMVSS: (2)R
Finish: Clear
Volts / Amps: 12V / .30A
Bracket: 43362, 43952, 43220, 43223, 43222, 43723, 43100
Grommet: 92420, 92720
Pigtail: 67014, 67020

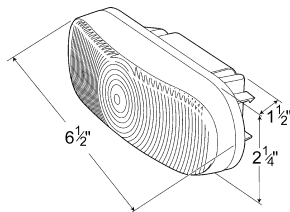

TORSION MOUNT® III OVAL MALE-PIN DUAL-SYSTEM BACKUP LAMP

Fits standard oval lamp grommets and brackets • Torsion Mount® III, Gel Mount® bulb cradle design ensures longer bulb life • Locking tabs ensure solid pigtail connection • O-ring seal design eliminates corrosion
• Requires two lamps to meet backup function

62241 Clear

KITS:

62261 Clear (62241 + 92420 + 67013)

Material: Polycarbonate
FMVSS: (2)R
Finish: Gray
Bulb: 1157 32 CP Volts / Amps: 12V / 2.1A
Bracket: 43362, 43952, 43220, 43222, 43223
Grommet: 92420, 92720
Pigtail: 66842, 67013, 66846, 67016

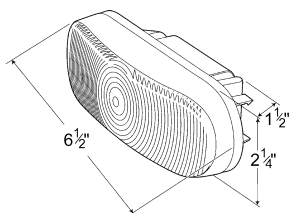

TORSION MOUNT® III OVAL DUAL-SYSTEM BACKUP LAMP

Fits standard oval lamp grommets and brackets • Torsion Mount® III, Gel Mount® bulb cradle design ensures longer bulb life • Requires two lamps to meet backup function

62231 Clear

KITS:

62251 Clear (62231 + 92420 + 67010)

Material: Polycarbonate
FMVSS: (2)R
Finish: White
Bulb: 32 CP Volts / Amps: 12V / 2.1A
Bracket: 43362, 43952, 43220, 43222, 43223
Grommet: 92420, 92720
Pigtail: 67010, 67011, 67014

ECONOMY OVAL DUAL-SYSTEM BACKUP LAMP

Requires two lamps to meet backup function • Hermetic lens-to-housing seal • Fits standard oval lamp grommets and brackets • Standard female-pin termination

62521 Clear

Material: Polycarbonate
 FMVSS: (2)R
 Finish: Clear
 Bulb: 1141 Volts / Amps: 12V / 2.1A
 Bracket: 43362, 43952, 43220, 43222, 43223
 Grommet: 92420, 92720
 Pigtail: 67010, 67011, 67014, 67021, 67020

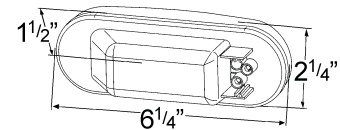

RECTANGULAR DUAL SYSTEM BACKUP LAMP

Tough polycarbonate lens • Hermetic lens-to-housing seal • Requires two lamps to meet backup function

62381 Clear

Material: Polycarbonate
 FMVSS: (2)R
 Finish: Clear
 Bulb: 2057 32 CP Volts / Amps: 12V / 2.1A
 Bracket: 43212
 Grommet: 94180
 Pigtail: 67011, 67010, 67012, 67014, 67015, 67020

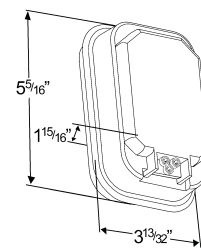

OE-STYLE DUAL-SYSTEM BACKUP LAMP

Requires small 1 1/16" hole for installation • Mounting pad included • For use on buses and trucks • Requires two lamps to meet backup function

62011 Gray, DURAMOLD® Bezel
62021 Chrome-Plated, DURAMOLD® Bezel
62021-5 Chrome-Plated, DURAMOLD® Bezel, Retail Pack

Material: ABS / Acrylic / Steel
 FMVSS: (2)R
 Finish: Gray / Chrome / Clear
 Bulb: 1156, 32 CP Volts / Amps: 12V / 2.1A
 Pigtail: 68080
 Lens: Clear 90221

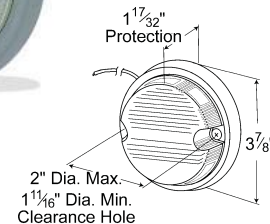

STAINLESS-STEEL RECESSED DUAL-SYSTEM BACKUP LAMP

Snap-in lens for easy replacement • Requires two lamps to meet backup function

62151 Clear
62201 Clear, High Polished Finish

Material: Stainless-Steel / Polycarbonate
 FMVSS: (2)R
 Finish: Stainless / Clear
 Bulb: 1156, 32 CP Volts / Amps: 12V / 2.1A
 Lens: Clear 91311

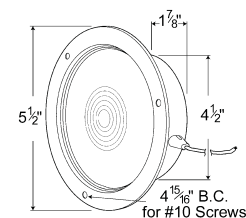

License and Backup

Feux de Plaque d'Immatriculation et de Recul

Lámparas de Placa / Reversa

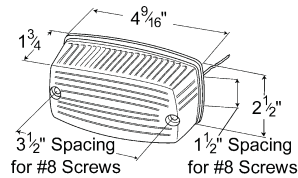

RECTANGULAR SURFACE-MOUNT DUAL-SYSTEM BACKUP LAMP

Raised lens for maximum light output • Surface mount requires no socket hole or cutout • Requires two lamps to meet backup function

62291 Clear

Material: Steel / Polycarbonate
 FMVSS: (2)R
 Finish: Clear
 Bulb: 1156, 32 CP Volts / Amps: 12V / 2.1A
 Lens: Clear 92761, Red 92762, Yellow 92763

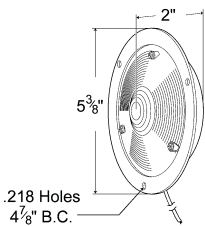

SHALLOW DIE-CAST UTILITY LAMP

Chrome-plated die-cast housing • Shallow profile for exterior sleeper cab application • Blunt cut wires

60311 Clear

Material: Zinc Die-cast / Acrylic
 Finish: Polished / Clear
 Bulb: 1156, 32 CP Volts / Amps: 12V / 2.1A
 Lens: Clear 91581, Red 91582, Yellow 91583

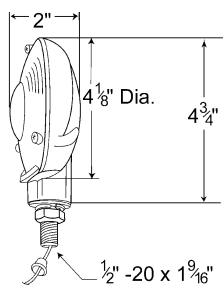

4" ZINC DIE-CAST SINGLE-FACE LAMP

3-screw acrylic lens • Less than 75 sq. cm. of effective projected luminous lens area • For use on vehicles under 80" wide • Grommeted wire exit • Single contact

63051 Clear, Black Enamel Finish

Material: Zinc Die-cast / Acrylic
 Finish: Black / Clear
 Bulb: 1156, 32 CP Volts / Amps: 12V / 2.1A
 Pigtail: 68170
 Lens: Clear 91581

LED WHITELIGHT™ RECESSED-MOUNT DOME LAMP

Encapsulant potting for total circuit-board protection • Robust, one-piece, aluminum housing and removable acrylic lens • Built-in automatic thermal protection device • Operates at temperatures -40°F to +122°F

HIGH OUTPUT VERSION:

- 61611** White
- 61261** White, Reduced Diode Count **new**
- 61111** White, 24-Volt **new**

DIMMABLE HIGH OUTPUT VERSION:

- 61E61** White **new**

MULTIPLE COMPARTMENT VERSION:

- 61881** White
- 61071** White, 24-Volt **new**

Material: Aluminum / Acrylic
 Finish: White
 Volts / Amps: 61611 - 12V / 2.16A
 Volts / Amps: 61261 - 12V / 1.75A
 Volts / Amps: 61111 - 24V / 1.0A
 Volts / Amps: 61E61 - 14V / 2.17A, .71A when dimming
 Volts / Amps: 61881 - 12V / 1.2A
 Volts / Amps: 61071 - 24V / .5A
 Lens: 94621, 94631 Mounting Pan: 43540

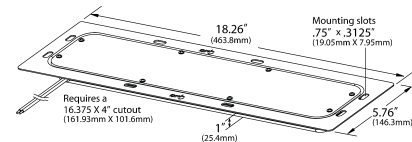

RECESSED-MOUNT FLUORESCENT DOME LAMP

Operates at temperatures 0°F to +125°F • Rapid start ballast design prevents electromagnetic and radio frequency interference (EMI / RFI) • Low current draw; maximum of 2.7 amps during start-up • Comes with in-line 3A fuse

- 61511** White

Material: DURAMOLD®
 Finish: White
 Volts / Amps: 12V / 2.5A
 Accessory: Mounting Pan: 43540 Bulb: 92911
 Lens: Clear 92901

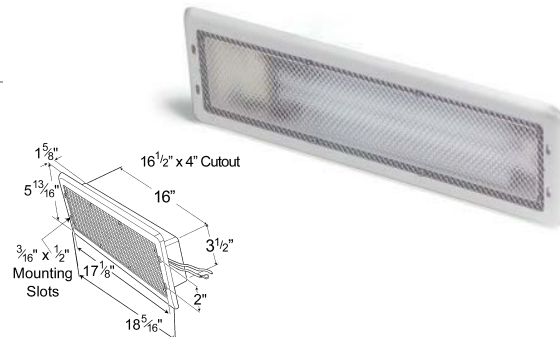

LED WHITELIGHT™ SURFACE-MOUNT DOME LAMP

Encapsulant potting for total circuit-board protection • Molded on / off switch • Built-in automatic thermal protection device • Operates at temperatures -40°F to +155°F • Lamp is protected against reverse polarity and short circuits • Extruded aluminum base provides excellent heat dispersal

- 61621** White

Material: Aluminum / Acrylic
 Finish: Black / Clear
 Volts / Amps: 12V / 1.5A

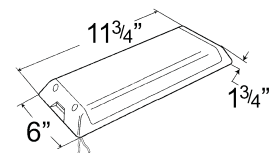

SURFACE-MOUNT FLUORESCENT DOME LAMP

Ballast design prevents electromagnetic and radio frequency interference (EMI / RFI) • Shock tested per SAE requirements • Rigid anodized aluminum base • Internally fused • Locking bulb mounts • Operating temperatures +32°F to +185°F

- 61371** White

Material: DURAMOLD®
 Finish: Clear / Black
 Bulb: Dual F15T8 Volts / Amps: 12V / 2.25A
 Accessory: Bulb: 92681 Lens: Clear 92611

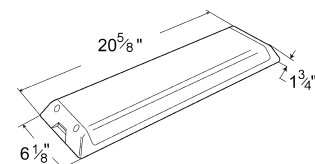

Interior Lighting

Lumières d'Intérieur Lámparas para Interior

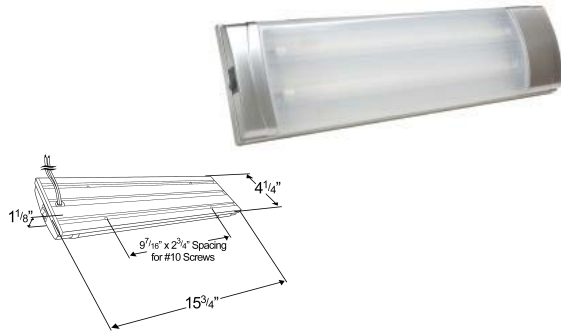

T5 FLUORESCENT TUBE DOME LAMP

Stylized surface-mount fluorescent lamp provides 800 lumens • Two thin, 8-watt tubes provide even light dispersion • Designed for RVs • Total weight is less than 1 lb. • Operates at +32°F to +122°F • Lamp has a non-replaceable 3 amp fuse

61901 Clear

Material: Polycarbonate
Finish: Clear / Aluminum
Bulb: (2) TF8T5 / CW, 8 Watt Volts / Amps: 12V / .95A
Lens: 93931



LED WHITELIGHT™ X-100 DOME LAMP

Thinnest LED lamp on the market • Built-in thermal protection device • Surface mountable; versatile design means both wall or ceiling mountings are possible • Fast installation with 2 self-tapping screws and no holes to cut

61121 White, 12-Volt **new**

61131 White, 24-Volt **new**

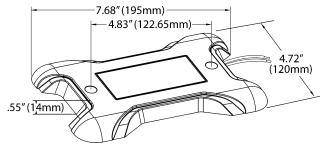

Material: Polycarbonate
Finish: Clear
Volts / Amps: 12V / .6A
Volts / Amps: 24V / .3A



LED WHITELIGHT™ SURFACE MOUNT DOME LAMP

3x brighter than existing 4" dome lamps • Low power consumption for efficient light output • Long-life LEDs, rated to 50,000 service hours • Surface-mount bracket comes pre-wired to lamp with push-button switch

61171 White **new**

Material: Polycarbonate / ABS
Finish: White / Gray
Volts / Amps: 12V / .6 A

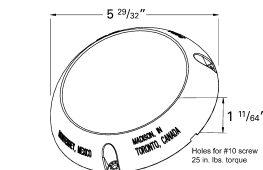

S100 LED WHITELIGHT™ SURFACE MOUNT DOME LAMP

Low profile sleek design, less than 15.0 mm height • Moisture-proof construction allows for a wide variety of uses • Surface mount allows for quick and easy installation • 300 lumens of output utilizing the latest LED WhiteLight™ technology • Operates at -40F to +122F • ECE R10, Dir. 72 / 245 / EEC, Amended by 2006 / 28 / EC

61391 S100 **new**

61401 S100, 24-Volt **new**

61411 S100 w / Motion Sensor **new**

61421 S100 w / Motion Sensor, 24-Volt **new**

Material: Polycarbonate
Finish: White
Volts / Amps: 12V / .7A; 24V / .38A

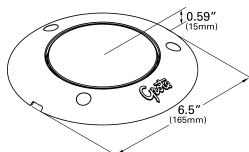

LED WHITELIGHT™ 4" ROUND DOME LAMP

Enhanced light pattern for better working environment, 3x brighter than existing 4" dome lamps • Multiple mounting configurations provide varied usage opportunities • Fits competitive brackets, grommets, and pigtails • Uses less power than incandescent and generates less heat • Rated to 50,000 service hours

- 61971** White new
- 61361** White (PL3 Plug) new

Material: Polycarbonate
 Finish: Clear
 Volts / Amps: 12V / .6A
 Bracket: 43343, 92510, 92512, 92513, 43253, 94540
 Grommet: 91740, 91950
 Pigtail: 67010, 67011

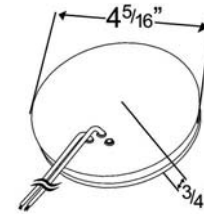

4" ROUND FLANGE-MOUNT LED DOME LAMP

Encapsulant potting for total circuit-board protection • 4-diode lamp has low-amp draw and low heat emission • Hard wire terminations allow for easy connections to the existing wiring system • Chemical-resistant acrylic lens, white powder coated housing • Low-profile design makes it great for trailer walls • Operates at a wide temperature range: from -40°F to +122°F • Theft-resistant flange mounted • Comparable light output to a 21-candle-power incandescent lamp, but with wider temperature tolerance

- 61141** White
- 61021** White, 24-Volt new

Material: Aluminum / Acrylic
 Finish: Clear
 Volts / Amps: 12V / .48A
 Volts / Amps: 24V / .25A

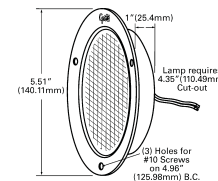

TORSION MOUNT® II 4" ROUND MALE-PIN DOME LAMP

Torsion Mount® II Gel-Mount® bulb cradle design • O-ring seal pigtail design eliminates corrosion • Locking tabs ensure solid pigtail connection • Hermetic lens-to-housing seal

- 61451** Clear
- KITS:**
- 61461** Clear (61451 + 91740 + 67013)

Material: Polycarbonate
 Finish: Clear
 Bulb: 15 CP
 Volts / Amps: 12V / 1.04A
 Bracket: 43572, 43253, 92510, 92512, 92513
 Grommet: 91740, 91950
 Pigtail: 67013, 66842, 66846, 67016

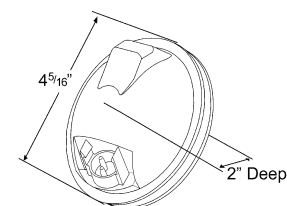

Interior Lighting

Lumières d'Intérieur Lámparas para Interior

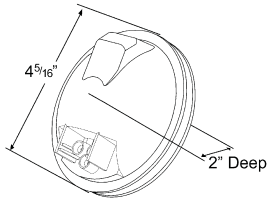

TORSION MOUNT® II 4" ROUND DOME LAMP

Torsion Mount® II Gel-Mount® bulb cradle design
 • Hermetic lens-to-housing seal

61051 Clear

KITS:

61431 Clear (61051 + 91740 + 67010)

Material: Polycarbonate
 Finish: White
 Bulb: 15 CP Volts / Amps: 12V / 1.04A
 Bracket: 43572, 43252, 91510, 92512, 92513
 Grommet: 91740, 91950
 Pigtail: 67010, 67011, 67012, 67020, 67015, 67014

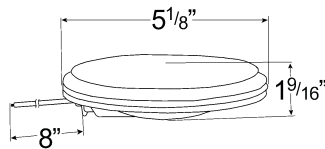

STEEL SEMI-RECESSED ROUND DOME LAMP

Low-profile design maximizes valuable cargo carrying capacity • Less than 1" profile from surface • Direct replacement for Kentucky Trailer® OE Dome Lamp • Recess depth requirement is less than 3/4" • Tough polycarbonate lens

61571 Clear

Material: Steel / Polycarbonate
 Finish: Clear
 Bulb: 1141, 21 CP Volts / Amps: 12V / 1.44A

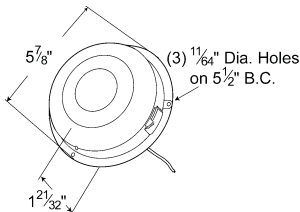

ROUND DOME LAMP WITH SWITCH

Surface mount • Corrosion- shatter- and heat-proof dome lamp • Low profile to protect against knock-off by load or personnel

61161 White Base
61091 Chrome Base
61091-5 Chrome Base, Retail Pack

Material: Polycarbonate
 Finish: Clear / Chrome
 Bulb: 93, 15 CP Volts / Amps: 12V / 1.04A
 Pigtail: 68170
 Lens: White 91101

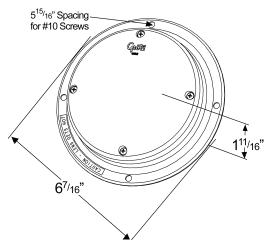

6" SURFACE MOUNT DOME LAMP

Surface mount lamp • Perfect for use as a compartment lamp • Popular lamp for bus and RV applications • Separate ground wire • Not suitable for use in headliners or confined spaces

61831 Clear

ON-OFF SWITCH:

61821 Clear

Material: Aluminum
 Finish: Silver / Clear
 Bulb: 1141, 21 CP Volts / Amps: 12V / 1.44A

6" OVAL SURFACE-MOUNT DOME LAMPS

Surface-mount lamp • Separate ground wire • Popular for use as a porch / utility lamp on RVs or on small trailers

61771 Clear

Material: DURAMOLD® / Acrylic
 FMVSS: CSA Certified
 Finish: Clear
 Bulb: 1141, 21 CP Volts / Amps: 12V / 1.44A

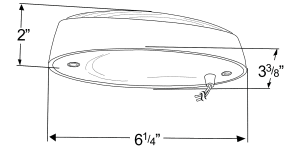

LED WHITELIGHT™ 7" ROUND DOME LAMP WITH DIMMING FUNCTION

High-output LED WhiteLight™ dome lamp with 3-wire termination for switching to dim mode • Commonly used in, but not limited to, ambulance applications • Encapsulated potting for total circuit-board protection against moisture and corrosion • Designed to operate in extremely cold temperatures down to -40°F • Shallow recess requires only 1 1/4" depth for mounting pan • Self-resetting cutoff feature to protect lamp against excess heat • When properly mounted, meets GSA-KKK 1828 ambulance dome lamp standards

61191 White new

Material: Powder Coated Steel / High Impact Acrylic
 Finish: White
 Volts / Amps: 12V / 2.38A, 0.7A when dimming

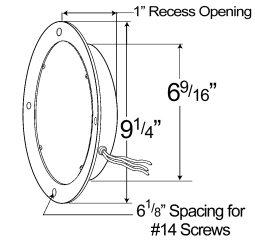

LED WHITELIGHT™ 7" ROUND DOME LAMP

High output white LED dome lamp • Encapsulant potting for total circuit-board protection against moisture and corrosion • Designed to operate in extreme cold temperatures of up to -40° • Shallow recess requires only 1 1/4" depth for mounting pan • Self-resetting cutoff feature to protect lamp against excess heat

61811 Clear

61061 Clear, 24-Volt new

Material: Powder Coated Steel / Acrylic
 Finish: White
 Volts / Amps: 61811 - 12V / 1.92A
 Volts / Amps: 61061 - 24 V / .75A
 Accessory: Mounting Pan: 43744
 Lens: Clear 93821

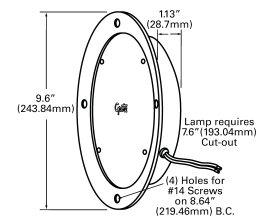

SEMI-RECESSED UTILITY LAMP

7" diameter with a recess less than 1 inch • Often used on school bus, RV and ambulance applications • Not for use in headliner or confined area • 3rd wire for dimming

63061 Clear

Material: Aluminum / Polycarbonate
 Finish: Clear / Aluminum
 Bulb: 1157, 32 CP Volts / Amps: 12V / 2.1A / .59A
 Lens: 93891

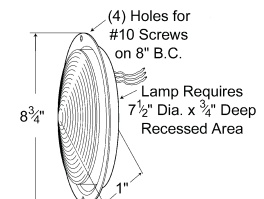

Interior Lighting

Lumières d'Intérieur L mparas para Interior

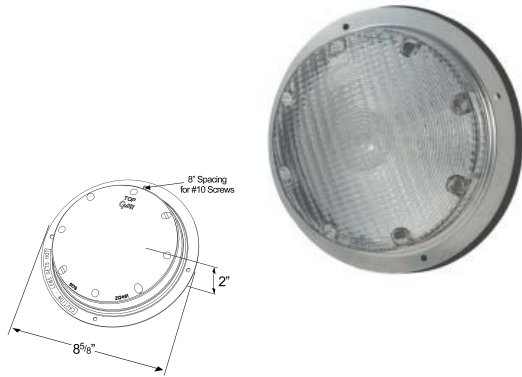

8" SURFACE-MOUNT DOME LAMPS

7" diameter lens • Surface mount lamp • Separate ground wire
• Popular for use as a scare lamp on RVs • Not suitable for use in headliners or confined spaces

CHROME HOUSING:

61793 Clear

Material: Steel
Finish: Clear / Chrome
FMVSS: CSA Certified
Bulb: 1156, 32 CP Volts / Amps: 12V / 2.1A
Lens: 93891



LED SLIMWHITE™

High output 500 lumen LED dome lamp emits low heat • Tough polycarbonate lens • Sturdy aluminium base • Profile is less than 3/4" high • Rated at 50,000 service hours

18" LENGTH:

61E81 Clear, **new**
61E91 Clear, 24-Volt **new**
61F01 Clear, w / Switch **new**
61F11 Clear, w / Switch, 24-Volt **new**

48" LENGTH:

61281 Clear, 48" long **new**

Material: Polycarbonate / Aluminium
Finish: Clear / White
Volts / Amps: 18"–12V / .6A, 24V / .3A; 48"– 12V / 1.2A

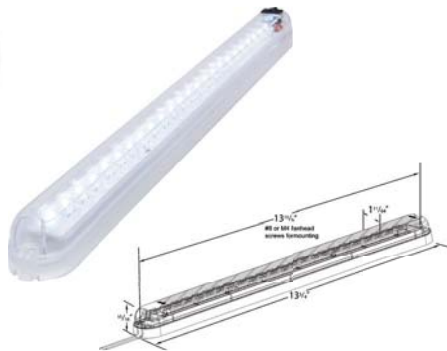

LED SLIMLITE COURTESY LAMP

Lamp features a low profile of less than one inch • High efficiency lamp generates good light output; uses little power and generates minimal heat
• Excellent option for cabinet lighting and other internal uses

60581 Clear **new**
60591 Clear, w / Switch **new**

Material: Polycarbonate
Finish: Clear
Volts / Amps: 12V / .23A



GROMMET-MOUNT OVAL LED DOME LAMP

Grote LEDs provide valuable light output with low-amp draw • Male-pin connection for use with Grote sealed harness system • Acrylic lens protects lamps in harsh environments

61981 Clear **new**

Material: ABS / Acrylic
Finish: Clear
Volts / Amps: 12V / .49A
Bracket: 43362, 43952, 43220, 43223, 43222, 43723
Grommet: 92420, 92720
Pigtail: 67013, 66842, 66846, 67016

COURTESY AND DOME RECTANGULAR LED LAMP

LED lamp is rated to 50,000 service hours • Fits existing, similar incandescent lamp mountings • Low heat will not melt lens • Encapsulant potting for total circuit-board protection against moisture and corrosion

DOMES VERSION

- 61861** White, 6 Diodes, Flush-Mount 9 to 30-Volt
- 61991** White, 6 Diodes, Recess-Mount 9 to 12-Volt **new**
- 61760** Red / White, 6 Diodes, 10 to 30-Volt **new**
- 61890** Blue / White, 6 Diodes, 18 to 32-Volt **new**

COURTESY VERSION

- 61871** White, 3 Diodes, Flush-Mount 9 to 30-Volt
- 61961** White, 3 Diodes, Recess-Mount 9 to 12-Volt **new**

Material: Aluminum / Polycarbonate
 Finish: Clear Gray / Black
 Volts / Amps: 61861 - 9V / .6A; 30V / .155A
 Volts / Amps: 61991 - 14V / .48A
 Volts / Amps: 61760 - 12V / .250A
 Volts / Amps: 61890 - 25.6V / .140A
 Volts / Amps: 61871 - 9V / .342A; 30V / .094A
 Volts / Amps: 61961 - 14V / .24A
 Lens: Clear 90401

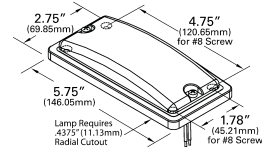

STANDARD MOUNT RECTANGULAR LED DOME LAMP

Fits popular 2 hole mount applications • Up to 50,000 service hours of operation from high-intensity LEDs • Low heat output for safer operation • Encapsulated potting protects against vibration and corrosion

HIGH OUTPUT VERSION:

- 61931** White, 6 Diodes, Recess-Mount **new**
- 61921** White, 3 Diodes, Recess-Mount **new**

Material: Aluminum / Polycarbonate
 Finish: Gray / Clear
 Volts / Amps: 61921 - 14V / .24A
 Volts / Amps: 61931 - 14V / .48A
 Lens: Clear: 90401

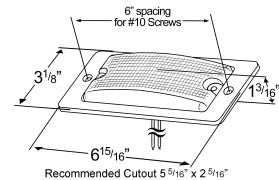

STEEL RECESSED RECTANGULAR DOME LAMP

Shatter-proof clear lens with screws for easy mounting or bulb replacement system • 15 CP bulb • Multiple versions available

- 61031** Clear

Material: Steel / Polycarbonate
 Finish: Clear
 Bulb: 93, 15 CP Volts / Amps: 12V / 1.1A
 Pigtail: 68080
 Lens: Clear 90401

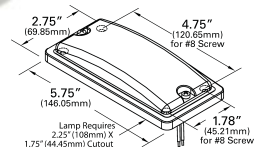

EUROSTYLE MAP AND DOME LAMP

3-way switch: map only, dome / map light, or off • Two options for wiring: either for dome to light or not to light, when door is open

- 61301** Clear

Material: Nylon / Polycarbonate
 Finish: Black
 Bulb: Dome - 561, 12 CP Volts / Amps: 12V / .97A
 Bulb: Map - 1816, 3 CP Volts / Amps: 12V / .33A

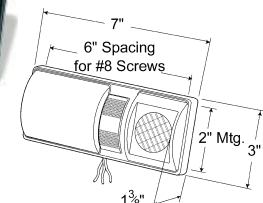

Interior Lighting

Lumières d'Intérieur Lámparas para Interior

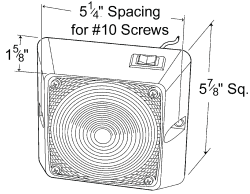

SQUARE DOME LAMP WITH SWITCH

Three-position switch enables variable intensity: low-6 CP, high-21 CP, or off
 • Surface mount • Large enough to cover most existing holes

61221 Clear

Material: ABS / Polycarbonate
 Finish: Black
 Bulb: 1016, 21 / 6 CP Volts / Amps: 12V / 1.5A max
 Lens: Clear 90481

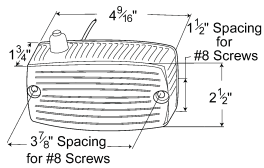

DOMELAMP WITH SWITCH

Durable polycarbonate lens • Integrated on / off toggle switch • Raised lens for maximum light dispersion • Comes with ground wire

61491-5 Clear, Retail Pack

Material: Steel / Polycarbonate
 Finish: Clear
 Bulb: 1156, 32 CP Volts / Amps: 12V / 2.1A

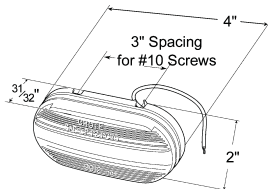

ECONOMY DOME LAMP

Surface-mount snap-on lens; molded O-ring • Low profile; less than 1 inch high

61081 Clear

Material: DURAMOLD®
 Finish: Clear
 Bulb: (2) 1893, 2 CP Volts / Amps: 12V / .66A
 Bracket: 43144
 Pigtail: 68280, 67120
 Lens: Clear 90121

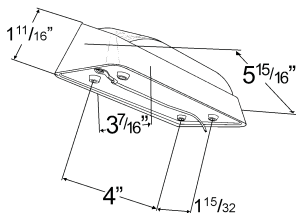

RECTANGULAR PORCH / UTILITY LAMP

Very popular for use as a porch / utility light on RVs and small trailers
 • Surface mount • Separate ground wire for use when mounting on fiberglass • Replaceable, snap-on lens

WITHOUT SWITCH:

61641 Clear, White Housing

Material: DURAMOLD®
 Finish: Clear / White
 FMVSS: CSA Certified
 Bulb: 1141, 21 CP Volts / Amps: 12V / 1.44A
 Lens: Clear 93491

SMALL RECTANGULAR LED UTILITY LAMP

Long-life LED light source makes this lamp the perfect choice for difficult-to-reach mounting locations • Bright LED design provides plenty of light for cabinets, tool boxes, etc. but consumes very little power • Uses same UBS pigtails as incandescent for a quick Plug-and-Go® retrofit • Encapsulant potting for total circuit-board protection • Hermetic lens-to-housing seal

60421 Clear

Material: Polycarbonate
 Finish: Clear
 Volts / Amps: 12V / .2A
 Bracket: 43380, 43370, 43970, 43980
 Pigtail: 66851, 66850, 67001, 66801, 67050

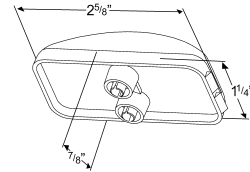

SMALL RECTANGULAR UTILITY LAMP

Sonically sealed lens • Single 15,000-hour bulb

60271 Clear

Material: Polycarbonate
 Finish: Clear
 Bulb: 2 CP Volts / Amps: 12V / .33A
 Pigtail: 66850, 67050, 67001, 66851, 66800, 66840
 Bracket: 43380, 43370, 43970, 43980

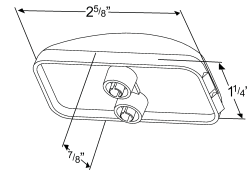

RECTANGULAR LED UTILITY LAMP

Long-life LED light source makes this lamp the perfect choice for difficult-to-reach mounting locations • Bright LED design provides plenty of light for cabinets, tool boxes, etc. but consumes very little power • Uses same UBS pigtails as incandescent for a quick Plug-and-Go® retrofit • Encapsulant potting for total circuit-board protection from corrosion • Hermetic lens-to-housing seal

60411 Clear

Material: Polycarbonate
 Finish: White
 Volts / Amps: 12V / .2A
 Bracket: 43780, 43783, 43390, 43790, 43850
 Pigtail: 66982, 66980, 66981

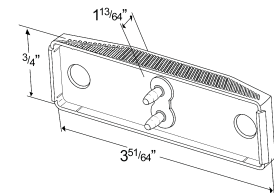

RECTANGULAR UTILITY LAMP

Sonically sealed, rectangular double-bulb lamp • Narrow mounting applications • 15,000-hour bulbs

60301 Clear

Material: Polycarbonate
 Finish: White
 Bulb: 2 CP
 Volts / Amps: 12V / .66A
 Bracket: 43390, 43780, 43790, 43850, 43783
 Pigtail: 66981, 66982

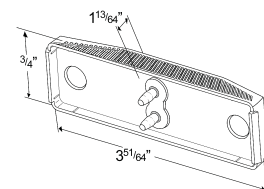

Interior Lighting

Lumières d'Intérieur Lámparas para Interior

LED

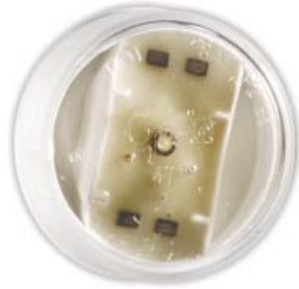
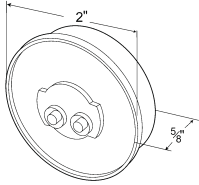

2" LED INTERIOR COURTESY LAMP

Bright, single LED provides ample light for tool boxes, cabinets, and other hard-to-light areas • Encapsulant potting for total circuit board protection against vibration and corrosion

60561 White **new**

Material: Polycarbonate
Finish: Clear
Volts / Amps: 14V / .2A
Bracket: 42190, 43690, 43150, 43152, 43153, 43532
Grommet: 92120, 92150, 94100
Pigtail: 66851, 66850, 66840, 67001, 67050, 66801

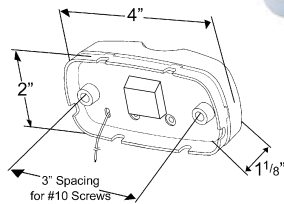

DURAMOLD® TWO-BULB SQUARE CORNER UTILITY LAMP

Ideal courtesy or dome lamp • Attached pigtail w / two stainless-steel grounds

46791 Clear

Material: DURAMOLD® / Acrylic
Finish: Clear
Bulb: 1893 (2), 2 CP Volts / Amps: 12V / .66A
Lens: Clear 91961
Pigtail: 67120

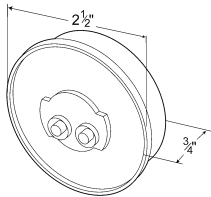

2 1/2" ROUND UTILITY LAMP

Ideal for utility, courtesy or dome applications • Hermetic lens-to-housing seal • 15,000-hour bulb • Twist-on mounting

45811 Clear

Material: Polycarbonate
Finish: White
Bulb: 2 CP Volts / Amps: 12V / .33A
Bracket: 43690, 43160, 43163, 43512, 43522
Grommet: 91880, 91890, 91400, 91410, 92070
Pigtail: 66851, 66850, 67001, 67050, 66801, 66800, 66840

LED

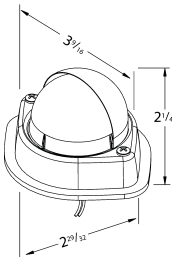

LED COURTESY STEPWELL LAMP

Electronics completely encapsulated with durable epoxy for maximum environmental protection • Same mounting as popular incandescent versions • Connections can be easily adjusted for typical installations • Designed for bus electronics, for seamless integration into existing platforms • ADA-compliant

60571 White **new**

Material: Stainless-Steel / Polycarbonate
FMVSS: ADA-compliant
Finish: Stainless
Volts / Amps: 14V / .3A

COURTESY STEP LAMP

Bright, polished stainless-steel construction • High heat- and impact-resistant lens • Adjustable hood for directional lighting • Bulb replaceable • Mounting pad and screws included

60361 Clear

Material: Stainless-Steel / Polycarbonate
 Finish: Stainless
 Bulb: 1142, 21 CP Volts / Amps: 12V / 1.44A

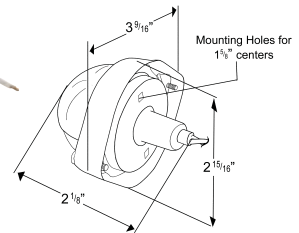

STEPWELL UTILITY LAMP

Rugged, heavy-duty design • Brilliant chrome finish • Easy to install • Includes foam mounting pad

60351 Clear

Material: Die Cast / Polycarbonate
 FMVSS: L
 Finish: Chrome
 Bulb: 906, 6 CP Volts / Amps: 12V / .7A
 Lens: 93201

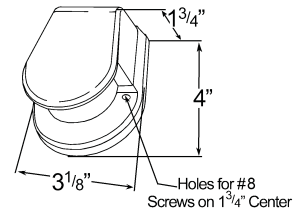

HI COUNT® LED COURTESY LAMP

• Mounts using 2 #6 screws • Longer life than incandescent; uses LED technology to reduce maintenance costs

G6261 Clear **new**

Material: Stainless-Steel
 Finish: Stainless
 Volts / Amps: 12V / .02A

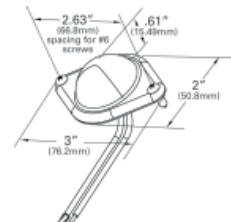

COURTESY LAMP

Chrome-plated steel housing • Single-bulb unit similar to lamps on Chevrolet® / GM® vehicles

60251 Clear
60251-5 Clear, Retail Pack

Material: Steel
 Finish: Chrome
 Bulb: 67, 4 CP Volts / Amps: 12V / .59A

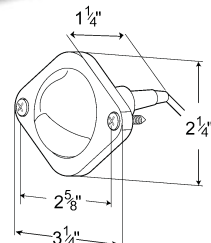

Interior Lighting

Lumières d'Intérieur Lámparas para Interior

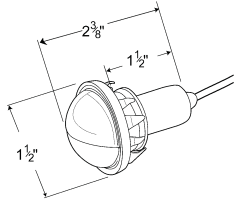

COMPACT COURTESY LAMP

Fits 1 1/4" hole in panels from .06 to .25" thick • Rubber-sealed spring and pigtail assembly • Translucent white plastic lens with chrome shade

60101 Clear
60101-5 Clear, Retail Pack

Material: Steel
Finish: Chrome
Bulb: 67, 4 CP Volts / Amps: 12V / .59A
Accessory: Socket Wire: 84-1003

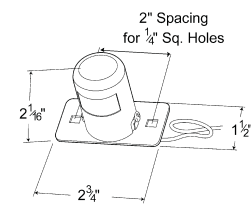

ECONOMY COURTESY LAMP

Illuminates instrument panels and compartments • Clear plastic lens

60151 Clear
60151-5 Clear, Retail Pack

Material: Steel
Finish: Stainless
Bulb: 67, 4 CP Volts / Amps: 12V / .59A
Pigtail: 68080

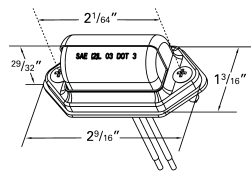

HI COUNT® LED INTERIOR / UTILITY LAMP

LED offering to provide maximum lighting output in tight spaces • Low power consumption and heat production • Hooded guard to reduce glare

G6151 Clear **new**

Material: Steel / Polycarbonate
Finish: Chrome
Volts / Amps: 12V / .25A

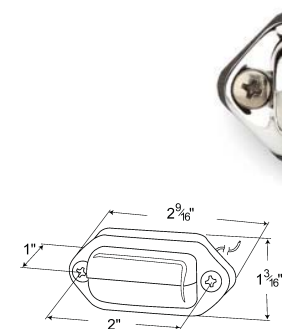

INTERIOR / UTILITY LAMP

Chrome-plated housing • Hooded guard to stop glare • Separate ground wire

61501 Clear
61501-5 Clear, Retail Pack

Material: Brass / Polycarbonate
Finish: Chrome
Bulb: 194, 2 CP Volts / Amps: 12V / .27A

LED ROPE LIGHTING

Flexible rope lighting is perfect for compartments and tool boxes • 50' roll comes with 10 wire connectors, 50 mounting clips and 10 end caps • 1/2" diameter rope • LEDs spaced 1 per inch

LED:	
60481	White
ACCESSORIES:	
93790	50 Mounting Clips

Finish: Clear
Volts / Amps: 60481 - 12V / 70 milliamps per foot



BEEHIVE LAMP WITH FIXED ANGLE MOUNTING BRACKET

Maximum light diffusion • Fade-proof acrylic lens

45021-5 Clear, Retail Pack

Material: DURAMOLD® / Acrylic
Finish: Clear / Black
Bulb: 67, 4 CP Volts / Amps: 12V / .59A
Lens: Clear 90301

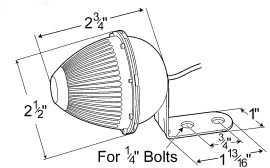

ELECTRONIC DOME LAMP SWITCH

Solid-state electronic circuitry • Impact-resistant PVC construction
• Sealed trigger switch • High current-switching capacity of 30 amps, not to exceed 15 operating amps • Wide voltage range 9- to 16-Volts

44240 Full-Feature, Surface Mount

Material: PVC
Finish: Gray
Volts / Amps: 12V / 15A max
Accessory: Automotive-style 15 A fuse

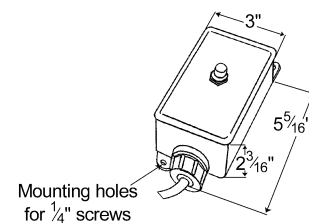

Interior Lighting

Lumières d'Intérieur Lámparas para Interior

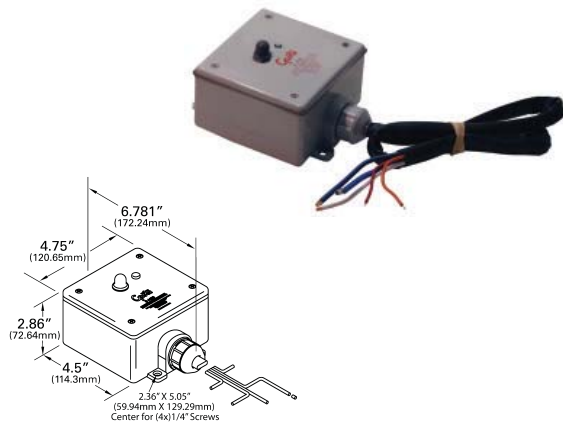

AUTOMATIC ELECTRONIC DOME LIGHT SWITCH WITH TIMER

Reduces the overall number of components of the interior lighting system

- Eliminates tapping into the air-brake delivery system
- Automatic shut-down of circuit for no-fuss on / off
- Driver can completely operate the system from the trailer if using with Grote's Momentary Ground Switch 44380
- Allows for multiple, simple ground-sensing switches while maintaining the integrity of the interior lighting system
- Timer can be set at 20, 40, 60, 90 minutes (factory preset is 40 minutes)

44360 Dome Lamp Switch **new**

44190 Dual Circuit **new**

Material: ABS

Finish: Gray

Volts / Amps: 9- to 16-Volt Range, 15A max load

Accessory: Replaceable Relay: 44430; Fuse: 15 A



RECESSED MOMENTARY GROUND SWITCH

Simple switch to reset the timer function of standard "outside-the-trailer" switches

- Recessed into the trailer wall to eliminate bumps or knock-offs
- Easy to integrate into the current system
- For use with 44360 and 44190 switches

44380 Switch **new**

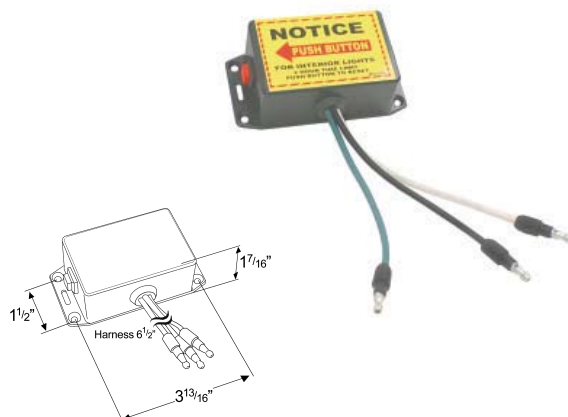

ECONOMY FULL-FEATURE TIMER SWITCH

Solid-state, low-profile design

- Two-hour timer
- Fully potted for protection against moisture
- 5-amp field-replaceable blade fuse

44242 Switch

Material: Polycarbonate

Finish: Black

Volts / Amps: 10 - 14V

TRILLIANT® LED WHITELIGHT™ HIGH-OUTPUT WORK LAMP

Long-lasting, high-output LED work lamp • Field tested in brutal off-road conditions • Beam pattern can be changed with optional replacement lenses • Easily mountable with a durable 1/2" stud mounting bracket; features Aim-N-Go® technology • Color temperature provides a natural contrast most like sunlight, reducing eye fatigue and optimizing job performance • Superior lamp for mining, military, construction, off-road, agriculture, utility and emergency vehicles and any application requiring a durable low-heat-emitting lamp that consistently delivers a bright light over time • ECE R10, Dir. 72 / 245 / EEC, Amended by 2006 / 28 / EC

- 63571 Spot new
- 63671 Spot, 24V new
- 63581 Flood new
- 63681 Flood, 24V new
- 63761 Wide Flood new
- 63771 Wide Flood, 24V new
- 63591 Trapezoid new
- 63691 Trapezoid, 24V new

Material: Powder Coated Steel / Cast Aluminum / Polycarbonate Lens
 Finish: Black
 Volts / Amps: 63571, 63581, 63761, 63591 10 - 30V / 5.2 - 1.5A
 Volts / Amps: 63671, 63681, 63771, 63691 24V - 2.1A
 Bracket: 43652
 Lens: Spot and Wide Flood Lens - 94580, Flood Lens - 94600,
 Trapezoid Lens - 94590

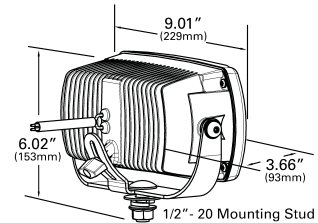

TRILLIANT® MINI LED WHITELIGHT™ WORK LAMP

50,000-hour LED WhiteLight™ for long-lasting service • Greater lumen output with lower power consumption than leading competitors' versions • Polycarbonate hard-coated lens provides many years of service • Color temperature provides a natural contrast most like sunlight, reducing eye fatigue and optimizing job performance • ECE R10, Dir. 72 / 245 / EEC, Amended by 2006 / 28 / EC

- 63601 Clear, Spot new
- 63731 Clear, Spot, 24V new
- 63611 Clear, Flood new
- 63741 Clear, Flood, 24V new
- 63621 Clear, Trapezoid new
- 63751 Clear, Trapezoid, 24V new

Material: Die-Cast Housing, Polycarbonate Lens
 Finish: Black
 Volts / Amps: 63601, 63611, 63621 12V / .8A
 Volts / Amps: 63731, 63741, 63751 24V / .4A

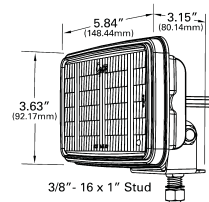

LED WHITELIGHT™ WORK LAMP IN PER-LUX® HOUSING

Durable, rugged housing with replaceable rock / chip guard • Heavy-duty stainless-steel housing for all-weather applications • 50,000 hour LED WhiteLight™ for long-lasting service • Color temperature provides a natural contrast most like sunlight, reducing eye fatigue and optimizing job performance • Greater lumen output with lower power consumption than leading competitors' versions • ECE R10, Dir. 72 / 245 / EEC, Amended by 2006 / 28 / EC

- 63641 Spot new
- 63651 Flood new
- 63661 Trapezoid new

Material: Stainless-Steel / Glass
 Finish: Stainless
 Volts / Amps: 12V / .8 A

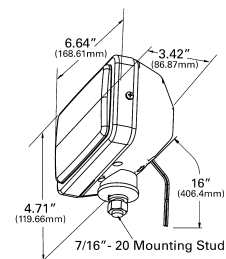

Forward Lighting

Phares Utilitaires Faros Delanteros

LED

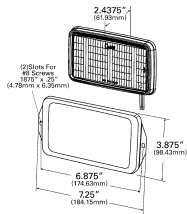

TRILLIANT® MINI FLUSH MOUNT LED WHITELIGHT™ WORK LAMP

Perfect for mounting in situations where bumps or knock-off might be a problem • Flood pattern gives a wide cast near the mounting source • 50,000-hour LED Whitelight™ for long lasting service • Greater lumen output with lower power consumption than leading competitors' versions • ECE R10, Dir. 72 / 245 / EEC, Amended by 2006 / 28 / EC

63610 Flood **new**

Material: Die-Cast Housing / Polycarbonate Lens / Stainless-Steel Bezel
Finish: Black / Stainless
Voltage Amp: 14V / .8A
Bracket: 94690

LED

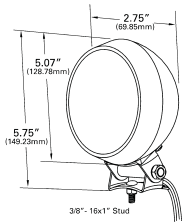

LED WHITELIGHT™ RUBBER UTILITY LAMP

Shock-absorbent, weather-proof housing with long-life LEDs makes this a very durable lamp • Cost-effective LED lighting option is rated at 50,000 hours • LEDs utilize lower amp draw, putting less load on strained electrical systems • Hard wired for easy integration into current wiring system

63551 Flood **new**
63561 Spot **new**

LAMP ONLY:

61971 Flood **new**
64971 Spot **new**

Material: Polycarbonate / Rubber
Finish: Black
Volts / Amps: 12V / .6A, 180 Lumens (63551 version)
Volts / Amps: 12V / .6A, 282 Lumens (63561 version)
Accessory: Lamp: 64971 (63561 kit), 61971 (63551 kit) Housing: 64930 Black
Magnetic Mount: 43300

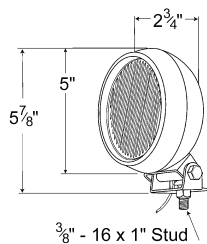

PAR 36 RUBBER TRACTOR AND UTILITY LAMP

Shock-absorbent weather-proof body • For versatile application as utility, fifth-wheel, backup, tractor, forklift or off-road vehicle lamp • Swivel mount • Trapezoid beam pattern

64931 12-Volt, Sealed Beam
64931-5 12-Volt, Sealed Beam, Retail Pack
64991 12-Volt, Halogen Sealed Beam
64981-5 6-Volt, Sealed Beam, Retail Pack ●
64921 24-Volt, Sealed Beam ●
64930 Housing only

MOUNTING HARDWARE:

43300 Magnetic Mount

Material: Rubber
Finish: Black
Bulb: 64931 - 4411, PAR 36, 35-Watt, 3,000 CP Volts / Amps: 12V / 2.7A
Bulb: 64991 - H7606, PAR 36, 50-Watt, 1,000 CP Volts / Amps: 12V / 3.9A
Bulb: 64891-5 - 4511, PAR 36, 30-Watt, 2,300 CP Volts / Amps: 6V / 4.8A
Bulb: 64921 - 4589, PAR 36, 50-Watt, 5,000 CP Volts / Amps: 24V / 1.8A
Accessory: 79-9005-48 hardware

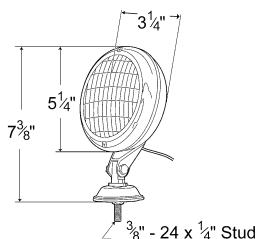

TRACTOR AND AUXILIARY LAMP

Sealed beam, pedestal-mount lamp for versatile up-and-down rotating adjustment to focus high-intensity light

64101 12-Volt, Sealed Beam

Material: Steel Finish: Black
Bulb: 4411, PAR 36, 35-Watt, 3,000 CP
Volts / Amps: 12V / 2.7A

PAR 36 STEEL HOUSING TRACTOR AND UTILITY LAMP

Shock-absorbent body increases bulb life • Swivel-mount for easy adjustments • Painted black

- 64441** 12-Volt, Trapezoid, Sealed Beam
- 64461** 24-Volt, Trapezoid, Sealed Beam
- 64440** Housing only

Material: Steel
 Finish: Black
 Bulb: 64441 - 4411, PAR 36, 35-Watt, 3,000 CP Volts / Amps: 12V / 2.7A
 Bulb: 64461 - 4589, PAR 36, 50-Watt, 5,000 CP Volts / Amps: 24V / 1.8A

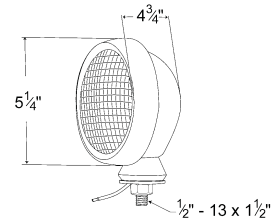

PAR 36 DURAMOLD® HALOGEN WORK LAMP

Rugged DURAMOLD® swivel cup ensures positive locked adjustment • Molded-in tabs for fast snap-in, snap-out bulb change • DURAMOLD® housing protects bulb from vibration

- 64411** Work Lamp

Material: DURAMOLD®
 Finish: Black
 Bulb: H7606, PAR 36, 50-Watt, 1,000 CP Volts / Amps: 12V / 3.9A

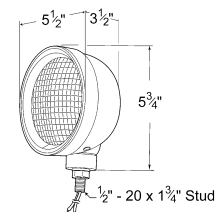

PAR 36 DURAMOLD® HALOGEN WORK LAMP WITH HOODED HOUSING

Welded mounting nut for firm positioning • Molded-in tabs for fast snap-in, snap-out bulb change • Shock-absorbent bulb cradle increases bulb life

- 64561** Work Lamp

Material: DURAMOLD®
 Finish: Black
 Bulb: H7606, PAR 36, 50-Watt, 1,000 CP Volts / Amps: 12V / 3.9A

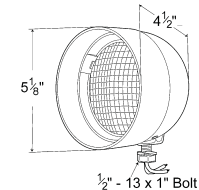

PAR 46 RUBBER TRACTOR AND UTILITY LAMP

Shock-absorbent, weather-proof body • For versatile application as utility, fifth wheel, backup, tractor, or off-road vehicle lamp • Swivel-mount bracketry

- 64471** 12-Volt, Spot
- 64941** 12-Volt, Flood, Sealed Beam
- 64491** 24-Volt, Sealed Beam
- 64943** 12-Volt, Yellow, Flood, Sealed Beam
- 64940** Housing only

Material: Rubber
 Finish: Black
 Bulb: 64471 - 4537, PAR 46, 100-Watt, 200,000 CP Volts / Amps: 12V / 7.7A
 Bulb: 64941 - 4413, PAR 46, 35-Watt, 1,100 CP Volts / Amps: 12V / 2.7A
 Bulb: 64943 - 4412A, PAR 46, 35-Watt, 8,800 CP Volts / Amps: 12V / 2.7A
 Bulb: 64491 - 4570, PAR 46, 150-Watt, 32,000 CP Volts / Amps: 24V / 5.4A

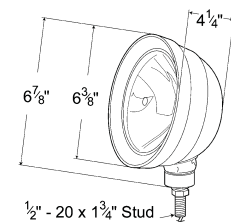

Forward Lighting

Phares Utilitaires Faros Delanteros

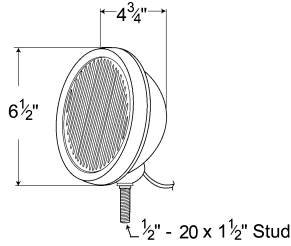

PAR 46 STEEL HOUSING TRACTOR AND UTILITY LAMP

Shock-absorbent body increases bulb life • Swivel-mount bracket for easy adjusting

- 64341** Sealed Beam
- 64391** 24-Volt, Sealed Beam ●
- 64340** Housing only

Material: Steel
 Finish: Black
 Bulb: 64341 - 4413, PAR 46, 35-Watt, 1,100 CP Volts / Amps: 12V / 2.7A
 Bulb: 64391 - 4570, PAR 46, 150-Watt, 32,000 CP Volts / Amps: 24V / 5.4A

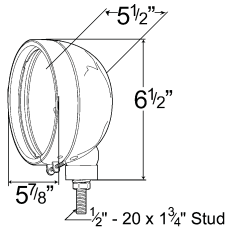

PAR 46 DRIVING LAMP HOUSING

Flange locks three lugs on sealed beams in precise legal position
 • Staked-in stud and swivel for full flexibility during installation and firm beam positioning

- 64031** Steel

Material: Cold Rolled Steel
 Finish: Metallic Powder Coated

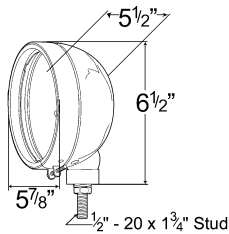

PAR 46 MULTI-FUNCTION HOUSING

Three built-in steel spring retainers for full flexibility in positioning bulb filament for desired light pattern • Staked-in stud and swivel designed for greater rigidity and strength to prevent rivets from loosening

- 64011** Steel
- 64021** Chrome-Plated

Material: Cold Rolled Steel
 Finish: Steel / Chrome

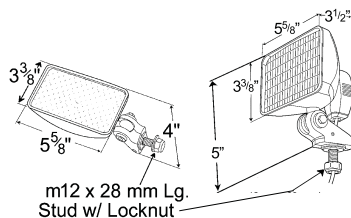

COMPOSITE WORK LAMP

Composite design (bulb replaceable) • Multiple beam patterns for use in any application • Side or top mount • John Deere® replacement lamp

- 63111-5** Top Mount, Flood, Retail Pack
- 63121-5** Top Mount, Spot, Retail Pack
- 63131-5** Top Mount, Trapezoid, Retail Pack
- 63321-5** Side Mount, Flood, Retail Pack
- 64611** Top Mount, Flood
- 64621** Side Mount, Flood

Material: DURAMOLD® / Glass
 Finish: Black
 Bulb: 888, 95 CP Volts / Amps: 12V / 3.9A

RECTANGULAR HALOGEN WORK LAMP

Rugged corrosion- and shock-resistant construction • Available in trapezoid, spot, and flood beam patterns • For versatile application needs: tractor, utility, fifth-wheel or off-road

- 63151-5** Flood, Retail Pack
- 63241-5** Flood, 24-Volt, Retail Pack ●
- 63161-5** Spot, Retail Pack
- 63171-5** Trapezoid, Retail Pack

Material: DURAMOLD®
 Finish: Black
 Bulb: 12-Volt - H3, 55-Watt, 121 CP Volts / Amps: 12V / 4.7A
 Bulb: 24-Volt - H3, 70-Watt, 146 CP Volts / Amps: 24V / 2.7A
 Accessory: Bulb: 12-Volt 90861-5 / 90971-5; 24-Volt 91051

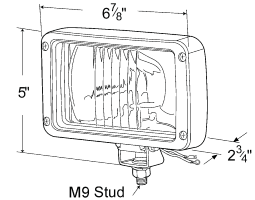

TWIN-BEAM HALOGEN WORK LAMP

Reinforced nylon housing for strength and durability • Hardened-glass lens resists breakage from road hazards • Complies with SAE J575e vibration and corrosion standards

- 64901** Flood new

Material: Nylon, Glass
 Finish: Black
 Bulb: H3 (x 2)
 Volts / Amps: 12V / 9.4A, 55-Watt Accessory: Bulb 90861-5, 90971-5

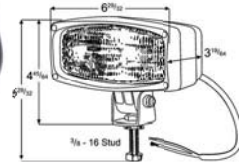

ROUND HALOGEN WORK LAMP

Rugged corrosion- and shock-resistant construction • Trapezoid, spot, and flood versions • For heavy or light duty • Versatile applications such as tractor, utility, fifth-wheel or off-road

- 63291-5** Flood, Retail Pack
- 63301-5** Spot, Retail Pack

Material: DURAMOLD®
 Finish: Black
 Bulb: 12 Volt: H3, 55-Watt, 121 CP Volts / Amps: 12V / 4.7A
 Bulb: 24 Volt - H3, 70-Watt, 146 CP Volts / Amps: 24V / 2.7A
 Accessory: Bulb: 12-Volt 90861-5 / 90971-5, 24-Volt 91051

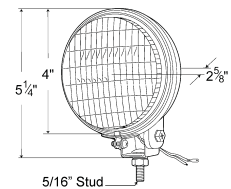

LARGE RECTANGULAR HALOGEN WORK LAMP

Rugged corrosion and shock resistant construction • Available in trapezoid, spot, and flood versions • For heavy or light duty • Versatile applications such as tractor, utility, fifth-wheel or off-road

- 63181-5** Flood, Retail Pack
- 63191-5** Spot, Retail Pack
- 63201-5** Trapezoid, Retail Pack
- 63251-5** Flood, 24-Volt, Retail Pack ●

Material: DURAMOLD®
 Finish: Black
 Bulb: 12 Volt: H3, 55-Watt, 121 CP Volts / Amps: 12V / 4.7A
 Bulb: 24 Volt - H3, 70-Watt, 146 CP Volts / Amps: 24V / 2.7A
 Accessory: Bulb: 12-Volt 90861-5 / 90971-5, 24-Volt 91051

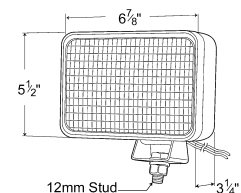

Forward Lighting

Phares Utilitaires Faros Delanteros

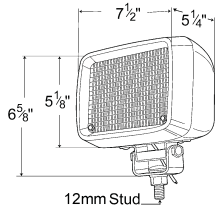

4" X 6" RECTANGULAR RUBBER WORK LAMP

80° total light spread • Lamp maintains structural integrity through all weather conditions (-50°F to +150°F) • Reinforced, ribbed housing for added strength • Adjustable bracket with 12 mm diameter stud

- 64891** Flood
- 63211-5** Flood, Retail Pack
- 63221-5** Halogen, Spot, Retail Pack
- 63231-5** Trapezoid, Retail Pack
- 64890** Housing only

Material: Rubber
 Finish: Black
 Bulb: Flood: 4913-1, 50-Watt, 1,350 CP Volts / Amps: 12V / 3.9A
 Bulb: Spot: H7935-1, 50-Watt, 175,000 CP Volts / Amps: 12V / 3.9A
 Bulb: Trapezoid - H4651, 50-Watt, 55,000 CP Volts / Amps: 12V / 3.9A

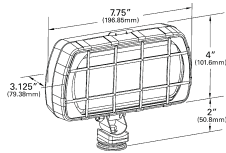

RECTANGULAR WORK LAMP WITH GRILL

- 63271** Auxiliary

Material: Polycarbonate / Glass
 Finish: Black
 Bulb: H3, 55-Watt Volts / Amps: 12V / 4.7A

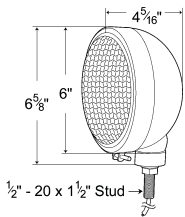

PAR 46 FOG LAMP

Built-in swivel base and spring-steel retainers • Flexibility in positioning • Staked-in stud and swivel design for greater rigidity and strength • DURAMOLD® swivel cup for positive lock and vibration absorption • Meets FMCSA 393.25(b)

- 64221** Gray Powder Coated **fog**

Material: Steel
 Finish: Gray
 Bulb: 4412, PAR 46, 35-Watt, 11,000 CP Volts / Amps: 12V / 2.7A

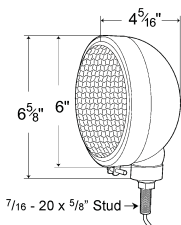

PAR 46 CHROMED BRASS FLOOD AND WORK LAMP

Chrome plate finish over brass body and rim protects against corrosion • Used with off-shore drilling, marine, and fire equipment applications • DURAMOLD® swivel cup for positive lock and vibration absorption • Meets FMCSA 393.25 (b)

- 64231** Chrome **fog**

Material: Brass
 Finish: Chrome
 Bulb: 4412, PAR 46, 35-Watt, 11,000 CP Volts / Amps: 12V / 2.7A

PAR 56 7" HEADLAMP

7-inch headlamp • Includes sealed beam 6014 for 12-Volt systems
 • Ideal for many trucks, road maintenance vehicles, off-road equipment, in-plant vehicles, material handling trucks, mine cars, dune buggies, etc.

64071 Black, Powder Coated

Material: Steel
 FMVSS: H
 Finish: Black
 Bulb: 6014, PAR 56, 50-Watt / 60-Watt, 25,000 / 32,000 CP
 Volts / Amps: 12V / 4.7A / 3.9A

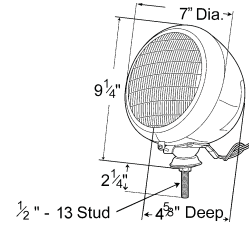

PAR 36 SURVEILLANCE LAMP

Thin-line style fits tight spaces to minimize bumps and knock-off hazards
 • Easy 2-screw sealed-beam replacement • Bright chrome housing
 • Housing works great with Trilliant® 36 LED Lamp.

64111 Surveillance Lamp
64120 Housing Only

Material: Steel
 Finish: Chrome
 Bulb: 7400, PAR 36, 35-Watt, 33,000 CP
 Volts / Amps: 12V / 2.7A

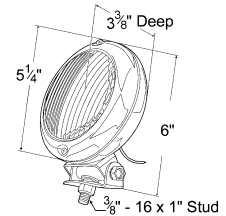

PAR 36 FOG LAMP

For cars, trucks or vans • Versatile mounting for any surface • Bright chrome housing

64123 Fog Lamp **fog**

Material: Steel
 Finish: Chrome
 FMVSS: F
 Bulb: 4415A, PAR 36, 35-Watt, 7,000 CP Volts / Amps: 12V / 2.7A
 Housing: 64170

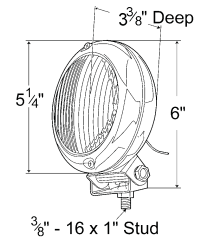

7" RECTANGULAR OFF-ROAD LAMP

Rugged steel housing • Universal swivel mounting bolt

64541-5 Black, Retail Pack
64551-5 Chrome, Retail Pack

Material: Steel
 Finish: Chrome, Black
 Bulb: H3, 100-Watt, 192 CP Volts / Amps: 12V / 8.33A
 Accessory: Bulb: 92701-5
 Lens: Clear 93151

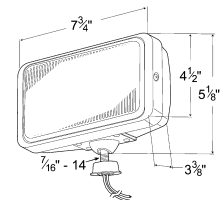

OVAL SINGLE-BEAM HALOGEN WORK LAMP

Glass-filled fiber-reinforced nylon housing • Hardened glass lens
 • Stainless-steel bracket • Internal metal reflector for high output
 • Meets SAE J575e vibration and corrosion standards • Flood pattern

64911 Clear **new**

Material: Nylon / Glass
 Finish: Black
 Bulb: H3, 55W, 21 CP Volts / Amps: 12V / 4.7A
 Accessory: Bulb: 90861-5, 90971-5

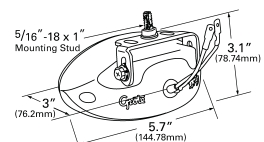

Forward Lighting

Phares Utilitaires Faros Delanteros



PAR 46 HAND-ADJUSTABLE SPOT LAMP

Permanent mount • Hand-adjustable • Suitable for roof mounting

63921 Spot

Material: Steel
 FMVSS: 0
 Finish: Chrome
 Bulb: H7635, PAR 46, 50-Watt, 160,000 CP Volts / Amps: 12V / 3.9A



PAR 46 CHROME SPOT LAMP

Adjustable tilt • Fixed mount

63941 Spot

Material: Steel
 FMVSS: 0
 Finish: Chrome
 Bulb: Spot: 4435, PAR 46, 30-Watt, 75,000 CP Volts / Amps: 12V / 2.3A
 Bulb: Flood: 4413, PAR 46, 35-Watt, 1,100 CP Volts / Amps: 12V / 2.7A

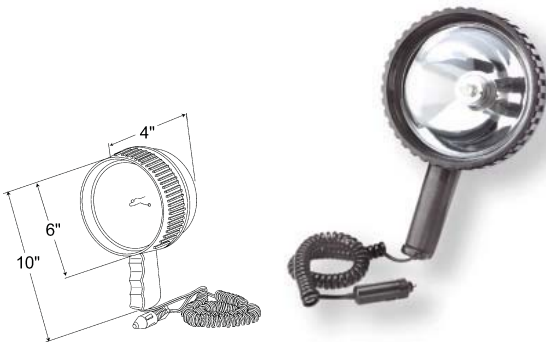

ROUND HAND-HELD SPOT LAMP

Plugs into 12-volt cigarette lighter • 12-ft coiled power cord
 • 300,000-candlepower lamp

64131 Spot, Retail Pack

Material: Polycarbonate
 Finish: Black
 Bulb: H3, 55-Watt Volts / Amps: 12V / 4.7A



HAND-HELD RECHARGEABLE SPOT LAMP

Two charging adapters: 12-volt or 110-volt AC • Trigger-style on / off switch
 • 1,000,000-candlepower lamp

64151 Spot, Retail Pack

Material: DURAMOLD®
 Finish: Yellow / Black
 Bulb: H3, 55-Watt Volts / Amps: 12V w / 110V AC Adapter / 4.7A

LIGHTWINDER® FLEXIBLE LED WORK LIGHT

Flexible LED light source • 3 ft. of light with 20-ft. cable • Uses standard 12-volt auxiliary vehicle plug for power • Useful 12-volt battery adaptor is included • Retail packaged for visual impact at point of sale • Perfect to store in trunk or under seat for quick access on the road • Perfect light source when stranded and need extra visibility, e.g. to change a tire • Long-life LEDs provide peace of mind • Perfect for outdoor hobbies or activities • Order 4 pieces and receive shelf point-of-purchase display

60551-5 White, Retail Pack **new**

Volts / Amps: 12V / 70 Milliamps per ft



PER-LUX® SNOWPLOW LAMPS

Resilient polycarbonate housing and sealed halogen beam withstands hours of use at sub-zero temperatures • Features integrated parking and turn signal lights • Rubber shock mount and center mounting stud absorb road shock • Optional 5-way Packard® Connector

SEALED BEAM:

- 64261-4** Pair Pack
- 64241** LH
- 64251** RH

SEALED BEAM WITH CONNECTOR:

- 64291-4** Pair Pack
- 64271** LH
- 64281** RH

Material: Polycarbonate
 FMVSS: H, I2, P
 Finish: Black
 Bulb: H6545, Major - 65-Watt, 40,000 CP / Minor - 45-Watt, 25,000 CP
 Volts / Amps: 12V / 5.0A / 3.5A
 Bulb: 1157, 32 / 3 CP Volts / Amps: 12V / 2.1A / .59A
 Pigtail: 68680 (64291-4)
 Lens: Yellow 90483

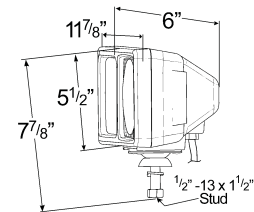

SNOWPLOW LAMP KIT WITH UNIVERSAL WIRING HARNESS

Integrated turn signal / parking lamp lens • Vibration-dampening mounting system prolongs bulb life • Kit includes left- and right-side lamps, heavy-duty selector switch, wiring connectors, mounting hardware and easy installation instructions

63451-4 Pair Pack

REPLACEMENT LAMP:

- 63381** LH
- 63391** RH

Material: Polycarbonate
 FMVSS: H, I2, P
 Finish: Black
 Bulb: H6054, Major - 65-Watt / Minor / 35-Watt Volts / Amps: 12V / 5A / 2.7A
 Bulb: 1157, 32 / 2 CP Volts / Amps: 12V / 2.1A / .59A
 Bulb: 1156, 32 CP Volts / Amps: 12V / 2.1A
 Lens: Yellow 93163

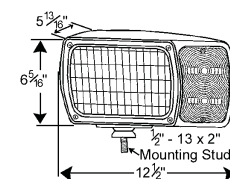

Forward Lighting

Phares Utilitaires Faros Delanteros

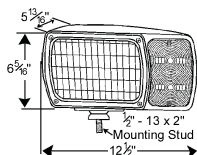

SNOWPLOW LAMP KIT WITH ECONOMY DO-IT-YOURSELF WIRING

Integrated turn signal / parking lamp lens • Vibration-dampening mounting system prolongs bulb life • Kit includes left- and right-side lamps, heavy-duty selector switch, wiring, connectors, mounting hardware and easy installation instructions

63441-4 Pair Pack

Material: Polycarbonate
 FMVSS: H, I2, P
 Finish: Black
 Bulb: H6054, Major - 65-Watt / Minor - 35-Watt Volts / Amps: 12V / 5A / 2.7A
 Bulb: 1157, 32 / 3 CP Volts / Amps: 12V / 2.1A / .59A
 Bulb: 1156, 32 CP Volts / Amps: 12V / 2.1A
 Lens: Yellow 93163

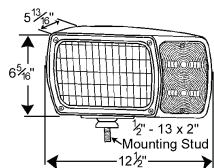

SNOWPLOW LAMP KIT WITH FOUR-POLE RETROFIT PLUG-IN HARNESS

Integrated turn signal / parking lamp lens • Vibration dampening, mounting system prolongs bulb life • Kit includes left and right side lamps, heavy-duty selector switch, wiring connectors, mounting hardware, and easy installation instructions

63401-4 Pair Pack

REPLACEMENT LAMP:

63381 LH
63391 RH

Material: Polycarbonate
 FMVSS: H, I2, P
 Finish: Black
 Bulb: H6054, Major - 65-Watt / Minor - 35-Watt Volts / Amps: 12 V - 5 / 2.7A
 Bulb: 1157, 32 / 3 CP Volts / Amps: 12V / 2.1A / .59A
 Bulb: 1156, 32 CP Volts / Amps: 12V / 2.1A
 Lens: Yellow 93163

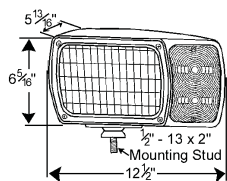

SNOWPLOW LAMP KIT WITH FIVE-POLE HEAVY-DUTY RETROFIT EXTENDED PLUG-IN HARNESS

Integrated turn signal / parking lamp lens • Kit includes left- and right-side lamps, heavy-duty selector switch, wiring connectors, mounting hardware and easy installation instructions • Vibration-dampening mounting system prolongs bulb life

63455-4 Pair Pack

Material: Polycarbonate
 FMVSS: H, I2, P
 Finish: Black
 Bulb: H6054, Major - 65-Watt / Minor - 35-Watt Volts / Amps: 12 V / 5A / 2.7A
 Bulb: 1157, 32 / 3 CP Volts / Amps: 12V / 2.1A / .59A
 Bulb: 1156, 32 CP Volts / Amps: 12V / 2.1A
 Lens: Yellow 93163

WING-TIP LED SNOWPLOW LAMPS

Fully encapsulated housing makes LED modules resistant to vibration, water, and salt and chemical resistance • Water-proof heavy-duty TPR cabling with built-in strain relief connectors is standard • Set of two light heads provides complete coverage whether snowplow blade is down and in use or in the stored travel position • Super-effective Class I LED strobe light modules have 11 light patterns to choose from

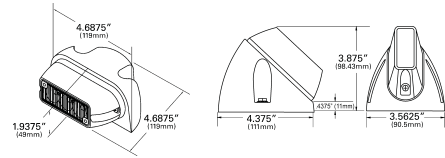

- 78573** Vertical
- 78563** Horizontal

Material: Die-Cast
 Finish: Clear
 Volts / Amps: 12V / .16A avg. / .4A peak

SNOWPLOW LIGHT 4-BEAM SYSTEM CONVERSION KIT FOR RETROFIT PLUG-IN HARNESS SYSTEM

For use on trucks with conventional four-beam headlight system employing sealed beams H4651, H4656, 4651 and 4652



- 68470** Adapter to be used with Grote 63401-4 lamps
- 68574** Adapter to be used with Grote 63455-4 lamps

SNOWPLOW LIGHT HARNESS CONVERSION KIT FOR FORD* / MAZDA* LIGHT TRUCKS

For use on late-model trucks with H9007 halogen beams



- 68471** Adapter to be used with Grote 63401-4 lamps
- 68571** Adapter to be used with 63431-4 and 63455-4 lamps

SNOWPLOW LIGHT HARNESS CONVERSION KIT FOR GMC* / CHEVY* / JEEP* TRUCKS

For use on trucks with low-profile four-beam headlight system with sealed beams H4701 and H4703



- 68472** Adapter to be used with Grote 63401-4 lamps

Forward Lighting

Phares Utilitaires Faros Delanteros



SNOWPLOW LIGHT GMC* / CHEVY* TRUCK CONVERSION KIT FOR COMPOSITE LIGHTING SYSTEM

For use on late-model trucks with composite four-bulb headlight system with H9005 and H9006 halogen bulbs

- 68473** Adapter to be used with Grote 63401-4 lamps
68573 Adapters to be used with Grote 63431-4 and 63455-4 lamps



SNOWPLOW HARNESS CONVERSION KIT FOR DODGE* / GMC* / CHEVY* TRUCKS

For use on late-model trucks with conventional type 2E1 sealed beams HP6545, H6545 and H4666

- 68474** Adapter to be used with Grote 63401-4 lamps
68574 Adapter to be used with Grote 63431-4 and 63455-4 lamps



SNOWPLOW LIGHT CONVERSION KIT FOR FORD* / DODGE* / TOYOTA* / NISSAN* / MAZDA* / ISUZU* TRUCKS

For use on late-model trucks with H9004 halogen bulbs

- 68475** Adapter to be used with Grote 63401-4 lamps

QUARTZ HALOGEN FOG AND DRIVING LAMPS

Rectangular, chrome-plated, adjustable mounting bracket with steel housing
 • Meets FMCSA 393.25(b) (except 64163-5)

- 64161-5** Clear, Fog Lamp, Retail Pack **fog**
- 64163-5** Yellow, Fog Lamp, Retail Pack **fog**
- 64181-5** Clear, Driving Lamp, Retail Pack

Material: Steel
 Finish: Chrome
 Bulb: H3, 55-Watt, 121 CP Volts / Amps: 12V / 4.7A
 Accessory: Bulb: 90861-5 / 90971-5
 Bracket: 43872
 Lens: Fog - Clear 92311, Yellow 92313; Driving - Clear 92321

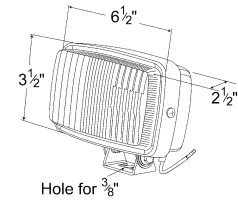

SLIM-LINE HALOGEN FOG LIGHTS

Housing made of die-cast aluminum • Ion-coated lens • Kit includes lamps, switch, wiring, and instructions • Not compliant for FMCSA 393.24(b) applications

- 64371-5** Clear, Fog Lamp Kit

Material: Die-Cast Aluminum
 FMVSS: F
 Finish: Black
 Bulb: H3, 55-Watt, 121 CP Volts / Amps: 12V / 4.7A
 Accessory: Bulb: 90861-5 / 90971-5
 Lens: Clear 93131

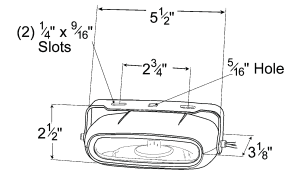

MICRO SLIM-LINE RECTANGULAR DRIVING LIGHTS

Housing made of die-cast aluminum • Ion-coated lens • Kit includes lamps, switch, wiring and instructions

- 64381-5** Clear, Driving Lamp Kit

Material: Die-Cast Aluminum
 FMVSS: Y
 Finish: Black
 Bulb: H3, 55-Watt, 121 CP Volts / Amps: 12V / 4.7A
 Accessory: Bulb: 90861-5 / 90971-5

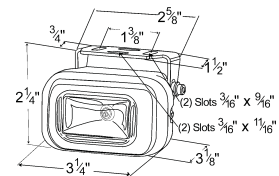

MINI HALOGEN FOG AND DRIVING LAMP KIT

Low-profile styling • High-impact DURAMOLD® housing • Kit includes lamps, rocker switch and installation kit • Not compliant for FMCSA 393.24(b) applications

- 64003-5** Yellow, Fog Lamp Kit, Retail Pack
- 64061-5** Clear, Driving Lamp Kit, Retail Pack

Material: DURAMOLD®
 Finish: Black
 Bulb: H3, 55-Watt, 121 CP Volts / Amps: 12V / 4.7A
 Accessory: Bulb: 90861-5 / 90971-5

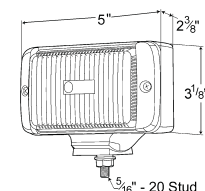

Forward Lighting

Phares Utilitaires Faros Delanteros



SLIM-LINE FOG LAMP KIT

Unique slim-line design for maximum road clearance • Rugged DURAMOLD® plastic housing • Kit includes lamps, rocker switch, mounting boot and installation kit • Not compliant for FMSCA 393.25(b) applications

64213-5 Yellow, Fog Lamp Kit, Retail Pack

Material: DURAMOLD®
 Finish: Yellow / Black
 Bulb: H3, 55-Watt, 121 CP Volts / Amps: 12V / 4.7A
 Accessory: Bulb: 90861-5 / 90971-5
 Lens: Clear- 93053

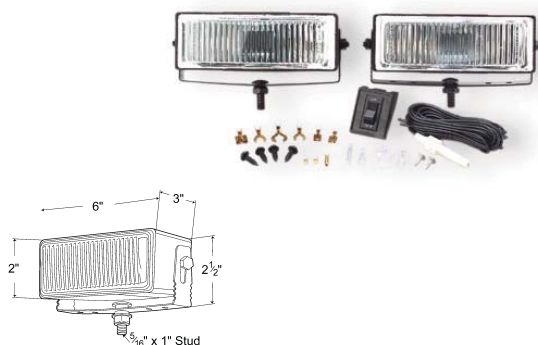

RECTANGULAR OEM-STYLE FOG LAMP KIT

Low-profile design mounts close to bumper for maximum road clearance • OE design • Three different mounting options: single-stud, two screws or industrial strength two-sided tape • Kit includes lamps, rocker switch and installation kit • Not compliant for FMSCA 393.25(b) applications

64301-5 Clear, Fog Lamp Kit, Retail Pack
64571 Replacement Lamp

Material: DURAMOLD®
 Finish: Black
 Bulb: H3, 55-Watt, 121 CP Volts / Amps: 12V / 4.7A
 Accessory: Bulb: 90861-5 / 90971-5
 Lens: Clear 93061



ROUND OEM-STYLE DRIVING LAMP KIT

Mounts close to bumper • Kit includes lamps, rocker switch and installation kit

64311-5 Clear, Driving Lamps, Retail Pack

Material: DURAMOLD®
 Finish: Clear / Black
 Bulb: H3, 55-Watt, 121 CP Volts / Amps: 12V / 4.7A

PROJECTOR BEAM DRIVING LAMP KIT

Hardened glass lens • Low profile mounting brackets • Three mounting options • Kit includes lamps, switch and installation kit

64631-5 Retail Pack

Material: Die-cast Aluminum / Glass
 Finish: Black
 Bulb: H3, 55-Watt, 121 CP Volts / Amps: 12V / 4.7A
 Accessory: Bulb: 90861-5 / 90971-5
 Lens: Clear 93081



SPORT AND UTILITY LAMP KIT

Constructed of rugged high-impact plastic • Hardened glass lens • Mounts above or below bumper • Kit includes lamps, rocker switch and installation kit • Meets FMCSA 393.25(b)

64351-5 Clear, Fog Lamp Kit, Retail Pack **fog**
64401-5 Clear, Driving Lamp Kit, Retail Pack

Material: ABS
 Finish: Clear / Black
 Bulb: H3, 55-Watt, 121 CP Volts / Amps: 12V / 4.7A
 Accessory: Bulb: 90861-5 / 90971-5
 Lens: Fog - Clear 93091, Drive - Clear 93101



COMPACT LAMP KIT

Slim oval design • Low-profile, mounting • Kit includes lamps, rocker switch and installation kit • Not compliant for FMCSA 393.25(b) applications

64431-5 Clear, Fog Lamp Kit, Retail Pack
64451-5 Clear, Driving Lamp Kit, Retail Pack

Material: ABS
 FMVSS: F
 Finish: Black
 Bulb: H3, 55-Watt, 121 CP Volts / Amps: 12V / 4.7A
 Accessory: Bulb: 90861-5 / 90971-5



COMBINATION FOG / DRIVING LAMP KIT

Both fog and driving lights in one lamp • Low-profile, slim design • Kit includes lamps, dual control rocker switch and installation kit • Not compliant for FMCSA 393.25(b) applications

64581-5 Retail Pack

Material: DURAMOLD®
 Finish: Black
 Bulb: H3, 55-Watt, 121 CP Volts / Amps: 12V / 4.7A
 Lens: Clear 93121

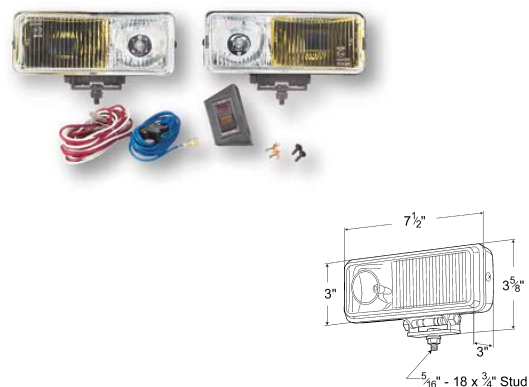

Forward Lighting

Phares Utilitaires Faros Delanteros

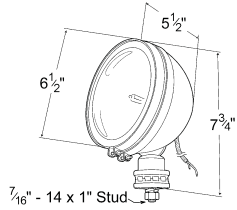

ROUND OFF-ROAD LAMP

Rugged steel housing • Universal-swivel rubber-cushioned mounting pedestal

64481-5 Black, Retail Pack
64501-5 Chrome, Retail Pack

Material: Steel
 FMVSS: 0
 Finish: Chrome / Black
 Bulb: H3, 100-Watt, 192 CP Volts / Amps: 12V / 8.33A
 Accessory: Bulb: 92701-5
 Lens: Clear 93171

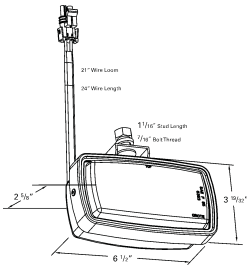

HALOGEN FOG LAMP

Glass lens resists hazing • Alumined reflector for increased brightness
 • Black powder-coated hardware • Industry-standard electrical connector
 • Watertight design on the front of the lamp • Meets FMSCA 393.25 (b)

63531 Black **new**

Material: Glass / Plastic Housing
 FMVSS: F
 Finish: Black
 Bulb: H3, 55-Watt, 121 CP Volts / Amps: 12V / 4.7A

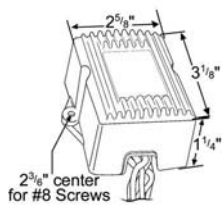

HEAVY-DUTY DAYTIME RUNNING LAMP MODULE

Operates low-beam headlamps at reduced intensity during daytime to increase bulb life • Module provides extra output that automatically activates the tail and marker circuits at night • Automatically switches between day / night operation • Fully potted, solid-state electronics
 • Features a "park brake disable" that switches the module off when the parking brake is engaged

44060 DRL Module

Material: Aluminum
 FMVSS: Exceeds CSA, SAE, and NHTSA requirements for DRL units
 Finish: Black
 Volts / Amps: 12V - 110-Watt max

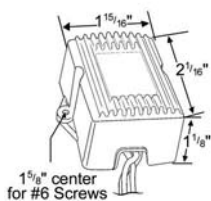

BASIC DAYTIME RUNNING LAMP MODULE

Simple daytime running lamp module activates the vehicle's low beam any time the ignition is on • Easy to install • Solid-state, fully potted electronics

44040 DRL Module

Material: Anodized Aluminum
 Finish: Black
 Volts / Amps: 12V / 110-Watt max

SWITCH ASSEMBLY

Includes switch, pilot light, mounting bracket and hardware
 • Maximum 10 amps

44151-5 Retail Pack

Volts / Amps: 12V / 10A max

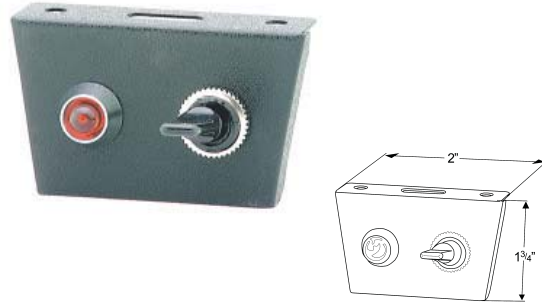

FOG AND DRIVING LAMP WIRING KIT

Kit includes illuminated rocker switch, 30 amp relay, terminated wires and fuse

68460-5 Retail Pack



FOG AND DRIVING LAMP RELAY

30-amp relay • Guards against arcing and overloads

44840-5 Retail Pack

Volts / Amps: 12V / 30A max

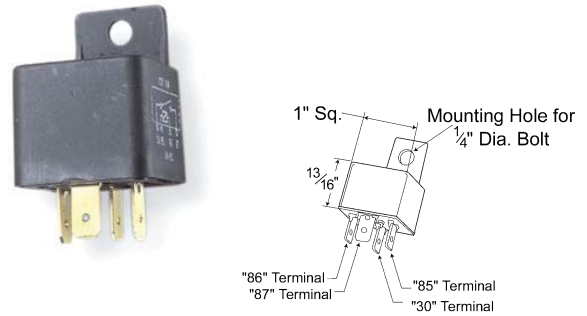

FOG AND DRIVING LAMP ROCKER SWITCH

Illuminated universal rocker switch • Handles up to 15 amps

44870-5 Retail Pack

Material: DURAMOLD®
 Volts / Amps: 6V / 12V / 24V / 15A max

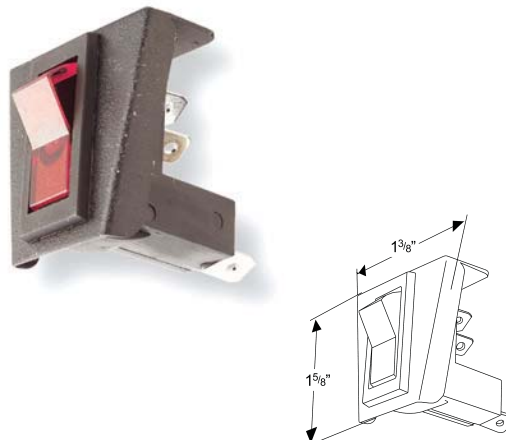

Forward Lighting

Phares Utilitaires Faros Delanteros

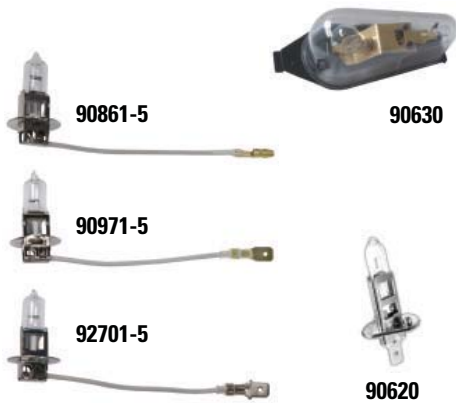

REPLACEMENT 12-VOLT HALOGEN BULBS

Replacement bulb for auxiliary lights

- 90861-5** 55-Watt, Bullet Terminal, Retail Pack
- 90971-5** 55-Watt, Spade Terminal, Retail Pack
- 92701-5** 100-Watt, Spade Terminal, Retail Pack
- 90630** Replacement Capsule Bulb **new**
- 90620** 55-Watt, High Output **new**

Bulb: 90861-5, 90971-5 - H3, 55-Watt, 121 CP Volts / Amps: 12V / 4.7A
 Bulb: 92701-5 - H3, 100-Watt, 187 CP Volts / Amps: 12V / 7A
 Bulb: 90630 Volts / Amps: 12V / 5.2A
 Bulb: 90620- H1, 55-Watt, 121 CP Volts / Amps: 12V / 5.2A



REPLACEMENT 24-VOLT HALOGEN BULBS

Replacement bulb for warning lights

- 91051** 70-Watt, Spade Terminal
- 90901** 50-Watt, Standard Socket

Bulb: 91051 - H3, 70-Watt, 135 CP Volts / Amps: 24V / 2.7A
 Bulb: 90901 - 50-Watt Volts / Amps: 24V / 2A

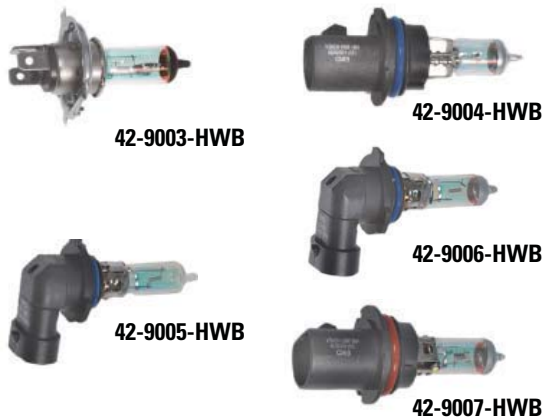

HIGH WATT BLUE LIGHT BULBS

High-watt halogen bulbs for off road use only • Attractive retail packaging

- 42-9003-HWB** P43T- 38 Base, HB2
- 42-9004-HWB** Axial Prefocus Base, HB1
- 42-9005-HWB** Right Angle Prefocus Base, HB3
- 42-9006-HWB** Right Angle Prefocus Base, HB4
- 42-9007-HWB** Axial Prefocus Base, HB5

Bulb: 42-9003-HWB Volts / Amps: 12V / 90 / 82-Watt
 Bulb: 42-9004-HWB Volts / Amps: 12V / 100 / 80-Watt
 Bulb: 42-9005-HWB Volts / Amps: 12V / 100-Watt
 Bulb: 42-9006-HWB Volts / Amps: 12V / 80-Watt
 Bulb: 42-9007-HWB Volts / Amps: 12V / 100 / 80-Watt



TRUE XENON BULBS

Xenon lamps are 30% brighter than standard halogen bulbs • Legal for off road use only

- 42-9003-TX** P43T - 38 Base, HB2
- 42-9004-TX** Axial Prefocus Base, HB1
- 42-9005-TX** Right Angle Prefocus Base, HB3
- 42-9006-TX** Right Angle Prefocus Base, HB4
- 42-9007-TX** Axial Prefocus Base, HB5

Bulb: 42-9003-TX Volts / Amps: 12V / 60 / 55-Watt
 Bulb: 42-9004-TX Volts / Amps: 12V / 65 / 45-Watt
 Bulb: 42-9005-TX Volts / Amps: 12V / 65-Watt
 Bulb: 42-9006-TX Volts / Amps: 12V / 55-Watt
 Bulb: 42-9007-TX Volts / Amps: 12V / 65 / 55-Watt

LONG-LIFE HALOGEN BULBS

Long life halogen replacement bulbs • Attractive retail packaging
• Rated for on road use

- 42-9004-LL** Axial Prefocus Base, HB1
- 42-9005-LL** Right Angle Prefocus Base, HB3
- 42-9005-13** P20D Base, HB3A (full case only)
- 42-9006-LL** Right Angle Prefocus Base, HB4
- 42-9006-13** P22D Base, HB4 (full case only)
- 42-9007-LL** Axial Prefocus Base, HB5 (full case only)
- 42-9008-13** PGJ19-2 Base, H11-55 / BP (full case only)

Bulb: 42-9004-LL Volts / Amps: 12V / 65 / 45-Watt
 Bulb: 42-9005-LL Volts / Amps: 12V / 65-Watt
 Bulb: 42-9005-13 Volts / Amps: 12V / 65-Watt
 Bulb: 42-9006-13 Volts / Amps: 12V / 55-Watt
 Bulb: 42-9006-LL Volts / Amps: 12V / 55-Watt
 Bulb: 42-9007-LL Volts / Amps: 12V / 65 / 55-Watt
 Bulb: 42-9008-13 Volts / Amps: 12V / 55-Watt



HALOGEN BULB CAPSULE

Rated for on road use

- 42-9003-H** P43T - 38 Base, HB2
- 42-9004-H** Axial Prefocus Base, HB1
- 42-9005-H** Right Angle Prefocus Base, HB3
- 42-9006-H** Right Angle Prefocus Base, HB4
- 42-9007-H** Axial Prefocus Base, HB5

Bulb: 42-9003-H Volts / Amps: 12V / 60 / 55-Watt
 Bulb: 42-9004-H Volts / Amps: 12V / 60 / 45-Watt
 Bulb: 42-9005-H Volts / Amps: 12V / 65-Watt
 Bulb: 42-9006-H Volts / Amps: 12V / 55-Watt
 Bulb: 42-9007-H Volts / Amps: 12V / 65 / 55-Watt



PER-LUX® 100 SERIES FOG AND DRIVING LAMPS

Stainless-Steel housing • Includes wiring kit • Fog lamp beam pattern pierces through fog, rain, snow and dust effectively, focused ahead and low to the road, giving side-to-side as well as forward illumination
 • Spot-lamp beam pattern provides focused light, piercing far into the night for long-distance viewing of a specific area most useful for off-road and 4-wheel drive applications • Not compliant for FMSCA 393.25(b) applications

HALOGEN:

01001-4 Clear, Fog Lamp, Swivel Mount, Pair Pack

INCANDESCENT:

01051-4 Clear, Spot Lamp, Swivel Mount, Pair Pack

Material: Stainless-Steel
 Bulb: 01001-4 - H7612, 15,000 CP Volts / Amps: 12V / 2.9A / 37.5-Watt
 Bulb: 01051-4 - 4049, 300,000 CP Volts / Amps: 12V / 11.7A / 150-Watt
 Accessory: Springs for Sealed Beam Ret. for Swivel Mount Lamps 09510 (pair pack); Washer for Leveling Ridge Mount Lamps 09430
 Lens: Replacement Sealed Beams: Clear, Halogen, Flood H7621-1;
 Clear, Halogen, Spot H7635; Clear, Halogen, Fog H7612;
 Clear, Incandescent, Utility 4419; Clear, Halogen, Utility H7619;
 Clear, Halogen, Flood H7609



Forward Lighting

Phares Utilitaires Faros Delanteros



PER-LUX® 200 SERIES FOG AND DRIVING LAMPS

All weather louvered lamps • Louvers direct the beam low to the road so reflected glare from fog, rain or snow is safely avoided • Pierces 100 feet through the densest fog • Pair packs include wiring kits • Rugged stainless-steel housing

HALOGEN:

- 02001-4** Clear, Fog / Driving Lamp, Swivel Mount, Pair Pack **fog**
02421-4 Clear, Halogen Lamp, Pair Pack **new**

Material: Stainless-Steel
 Finish: Stainless
 Bulb: H7621-1, 20,000 CP Volts / Amps: 12V / 3.9A / 50-Watt
 Accessory: Springs for Sealed Beam Ret. For Swivel Mount Lamps 09510 (pair pack); Washer for Leveling Ridge Mount Lamps 09430
 Lens: Clear Glass 09561; Clear Sealed Beam, Halogen H7621-1



PER-LUX® 500 SERIES FOG AND DRIVING LAMPS

Pair Packs include wiring kits • All lamps come with swivel mount
 • Fog lamp beam pattern pierces through fog, rain, snow, or dust effectively, focused ahead and low to the road, and giving a side-to-side as well as forward illumination • Spot lamp beam pattern provides focused light, piercing far into the night for long distance viewing of a specific area, most useful of off-road and 4-wheel drive applications

HALOGEN:

- 05001-5** All Weather Louvered, H9421, Pair Pack, Stainless-Steel
05151 All Weather Louvered, H9421, Single, Stainless-Steel,
05301-5 All Weather Louvered, H9421, Pair Pack, Powder Coated
05401 All Weather Louvered, H9421, Single, Powder Coated
05013-5 All Weather Louvered, H9421, Pair Pack, Stainless-Steel, Yellow Lens
05041-5 Driving Lights, H9420, Pair Pack, Stainless-Steel
05171 Driving Lights, H9420, Single, Stainless-Steel
05051-5 Fog Lamps, H9415, Pair Pack, Stainless-Steel **fog**
05063-5 Fog Lamps, H9415A, Pair Pack, Stainless-Steel, Yellow Lens **fog**
05071-5 Spot Lamps, H9405, Pair Pack, Stainless-Steel **fog**

Material: Stainless-Steel
 Finish: Stainless / Powder Coat
 Bulb: H9421 - 14,000 CP Volts / Amps: 12V / 3.9A / 50-Watt
 Bulb: H9420 - 47,000 CP Volts / Amps: 12V / 3.9A / 50-Watt
 Bulb: H9415 - 12,000 CP Volts / Amps: 12V / 2.9A / 37.5-Watt
 Bulb: H9415A - 9,600 CP Volts / Amps: 12V / 2.9A / 37.5-Watt
 Bulb: H9405 - 100,000 CP Volts / Amps: 12V / 3.9A / 50-Watt
 Accessory: Springs for Sealed Beam 09510; Black Louver 09712
 Lens: Glass Lens Clear 09681; Glass Lens Yellow 09693
 All-Weather, Halogen, Sealed Beam Clear H9421
 Spot Lamp, Halogen, Sealed Beam Clear H9405
 Flood Lamp, Halogen, Sealed Beam Clear H9406
 Utility Lamp, Halogen, Sealed Beam Clear H9411
 Flood Lamp, Halogen, Sealed Beam Clear H9414
 Fog Lamp, Halogen, Sealed Beam Clear H9415

PER-LUX® 550 SERIES DRIVING LAMPS

Black Noryl® housing • Includes wiring kit, swivel mount and hard cover

HALOGEN:

05511-5 Driving Lamps, H9420, Pair Pack

- Material: Noryl®
- Finish: Black
- Bulb: H9420, 47,000CP Volts / Amps: 12V / 3.9A / 50-Watt
- Accessory: Black Louver, 09712
- Lens: All-Weather Lamp, Halogen, Clear, H9421
 - Spot Lamp, Halogen, Clear, H9405
 - Flood Lamp, Halogen, Clear, H9406
 - Utility Lamp, Halogen, Clear, H9411
 - Flood Lamp, Halogen, Clear, H9414
 - Fog Lamp, Halogen, Clear, H9415
 - Fog Lamp, Halogen, Yellow, H9415A

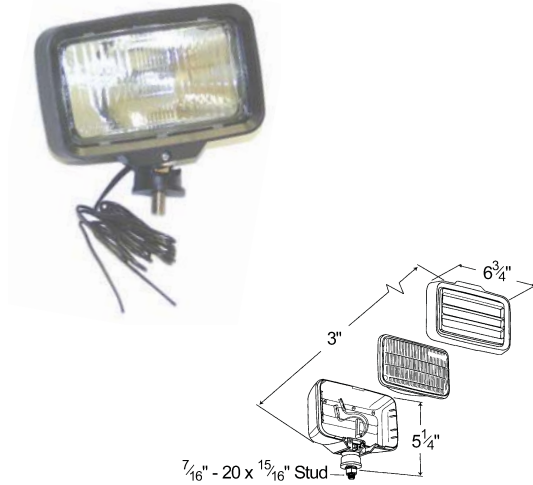

PER-LUX® 600 SERIES FOG AND DRIVING LAMPS

Louvers direct the beam low to the road so reflected glare from fog, rain or snow is safely avoided • Pierces 100 feet through the densest fog • Rugged stainless-steel housing • Pair packs come with wiring kits

06021-4 Clear, All-Weather Lamp, Swivel Mount, Pair Pack **fog**

HALOGEN:

- 06001-4** Clear, All-Weather Lamp, Swivel Mount, Pair Pack
- 06201** Clear, All-Weather Lamp, Swivel Mount
- 06013-4** Yellow, All-Weather Lamp, Swivel Mount, Pair Pack

- Material: Stainless-Steel
- Finish: Stainless
- Bulb: H7921-1, 23,900 CP Volts / Amps: 12V / 3.9A / 50-Watt
- Bulb: 4921-1, 25,000 CP Volts / Amps: 12V / 7.7A / 100-Watt
- Accessory: Leveling Washer for Rigid Mount Lamps 09430; Black Louver 09802
- Lens: Clear, Glass 09781; Yellow, Glass 09793
- Sealed Beam – Clear All-Weather, Incandescent 4921-1
 - Clear, All-Weather, Halogen 6006H

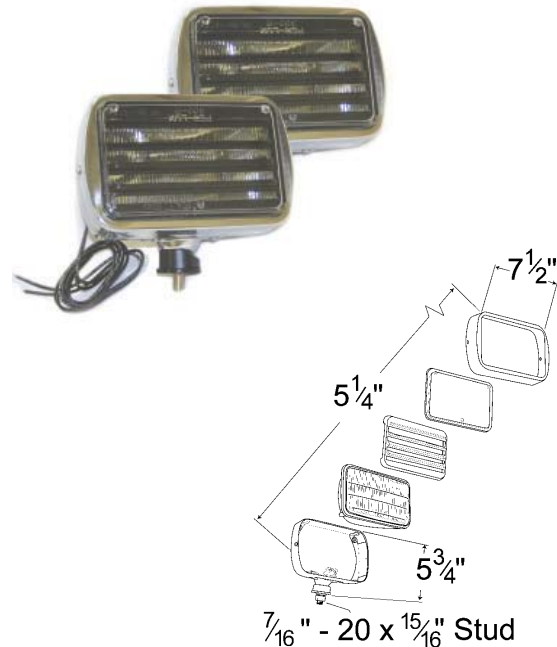

Forward Lighting

Phares Utilitaires Faros Delanteros

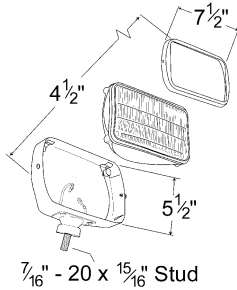

PER-LUX® 700 SERIES FOG AND DRIVING LAMPS

Fog lamp beam pattern pierces through fog, rain, snow or dust effectively, focused ahead and low to the road, giving side-to-side as well as forward illumination • Off-road spot lamps provide pure, focused light that pierces far into the night for long distance viewing of a specific area • Great for off-road and 4-wheel-drive applications • Off-road wide flood lamp applications provide wide illumination for RVs, motor homes, tractors, utility, and off-road construction, great for backing, loading, fueling or troubleshooting • Rugged stainless-steel housing • Pair packs come with wiring kit

INCANDESCENT:

- 07001-4** Clear, Fog Lamp, Swivel Mount, Pair Pack **fog**
- 07201** Clear, Fog Lamp, Swivel Mount **fog**
- 07401** Clear, Fog Lamp, Rigid Mount **fog**

HALOGEN:

- 07021-4** Clear, Spot Lamp, Swivel Mount, Pair Pack
- 07031-4** Clear, Wide Flood Lamp, Swivel Mount, Pair Pack

Material: Stainless-Steel

FMVSS: Street Legal (except for 07021-4, 07031-4)

Finish: Stainless

Bulb: 4912-1, 14,000 CP Volts / Amps: 12V / 3.9A / 50-Watt

Bulb: H7935-1, 175,000 CP Volts / Amps: 12V / 3.9A / 50-Watt

Bulb: H7921-1, 23,900 CP Volts / Amps: 12V / 3.9A / 50-Watt

Accessory: 09340 Leveling Washers for Rigid Mount Lamps

Lens: Sealed Beam – Clear, Fog, Incandescent 4912-1

Clear, Flood, Incandescent 4913-1; Clear, Utility, Incandescent 4919-1

Clear, Spot, Halogen H7935-1



PER-LUX® DOCKING LIGHT

Flush mounted • Multi-purpose docking / utility light

HALOGEN:

- 07803** Lamp w / Stainless-Steel Bezel

Material: Stainless-Steel

Finish: Stainless

Bulb: H9406, 1,350CP Volts / Amps: 12V / 3.9A / 50-Watt

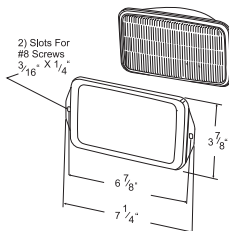

LOW PROFILE LED STROBES

Rated life of LEDs strobes is up to 50 times longer than standard strobes

- SignalAlert™ provides greater visibility by creating a varied flash pattern (vs. standard strobes with a consistent flash pattern)
- Scan-Lock™ flash pattern allows the user to manually select from 14 permanent flash patterns
- LED beacon design internally houses the flash control, eliminating the need for an external power supply or ballast

77811 Clear
77813 Yellow

MAGNET MOUNT WITH CIGARETTE LIGHTER ADAPTER:

77823 Yellow

Class: II
Material: Polycarbonate
SAE: J845
Finish: Clear / Yellow / Black
Volts / Amps: 12V / .65A max
Lens: Yellow 93733

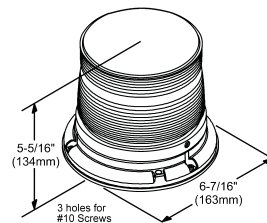

MEDIUM PROFILE LED STROBES

Rated life of LEDs strobes is up to 50 times longer than standard strobes

- SignalAlert™ provides greater visibility by creating a varied flash pattern as opposed to standard strobes with a consistent flash pattern
- Scan-Lock™ flash pattern allows the user to manually select the permanent flash pattern, 14 to choose from
- LED Beacon design internally houses the flash control so there is no need for an external power supply or ballast

77833 Yellow

MAGNET MOUNT WITH CIGARETTE LIGHTER ADAPTER:

77843 Yellow

Class: II
Material: Polycarbonate
SAE: J845
Finish: Yellow / Black
Volts / Amps: 12V / .65A max
Lens: Yellow 93743

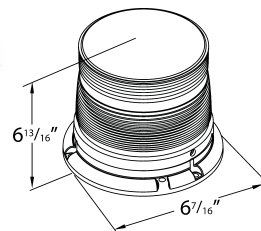

360° LED STROBE LIGHT

Three mounting holes with mounting hardware on black anodized aluminum base for resistance against corrosion

- Gasketed amber polycarbonate high impact lens is fastened onto the base to enclose and protect the LED circuit-board assembly
- 12-Volt quad flash pattern is ideal for material handling equipment
- 63 FSPM (flash sequences per minute) in quad flash mode
- LED's feature long-lasting, low-amp draw for maintenance-free operation
- 18 columns and 4 rows (77853) or 8 rows (77863) of high-intensity surface-mounted LEDs wrapped around an aluminum heat-sink to dissipate heat

CLASS II
77863 Yellow **new**

CLASS III
77853 Yellow **new**

Class: II: 77863, III: 77853
Material: Aluminum / Polycarbonate
SAE: J845
Finish: Yellow
Bulb: 9V - 16V 77863 Volts / Amps: 12V / 4.2A
Bulb: 9V - 16V 77853 Volts / Amps: 12V / 2.1A
Accessory: Magnet Mount: 96020

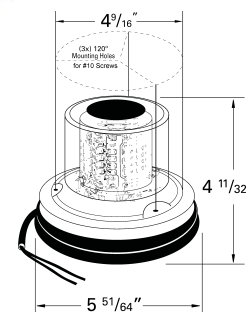

Warning and Hazard

Gyrophares et Feux d'Avertissement Lámparas de advertencia y precaución

LED

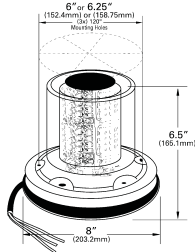

360° INTERMEDIATE ROTATING LED STROBE

High-intensity quad flash or simulated rotational pattern • Black anodized base with a rugged, polycarbonate lens • 63 FSM (quad settings) or 90 FSPM (rotational settings) • 144 LEDs mounted in 18 columns and 8 rows
 • Long-lasting, low-amp draw for maintenance-free operation • Variable hole positions for mounting

77893 Yellow **new**

Class: II
 Material: Aluminum / Polycarbonate
 SAE: J845
 Finish: Black / Yellow
 Volts / Amps: 9V - 32V / 1.5A at 12.8V average, 4.2A peak

LED

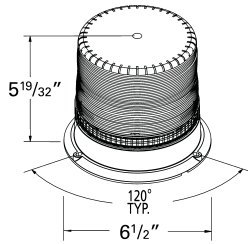

HIGH-INTENSITY LED BEACON

Eight 3-watt LEDs provide unrivaled flash intensity • Double (80) or quad (65) flash operation with hi / lo intensity control • Die cast aluminum base is coated against corrosion; designed for vibration resistance and heat dispersion • Thread-on polycarbonate lens allows for easy "no-tool" pattern selection • Reverse-polarity, voltage-spike and surge-protected
 • 12- to 24-V operation spread

77873 Yellow **new**

Class: I
 Material: Aluminum / Polycarbonate
 SAE: J845
 Finish: Yellow
 Bulb: 12V - 24V
 Volts / Amps: 3.7A

LED

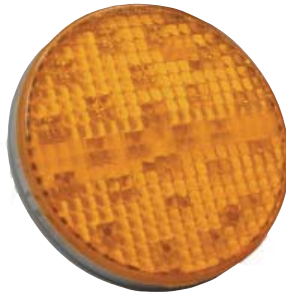
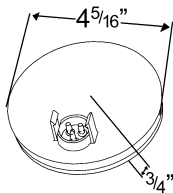

4" LED STROBE LIGHTS

Encapsulant potting offers maximum protection of the circuit board against dirt, moisture and corrosion • Internal circuitry eliminates the need for an external power supply or control module • Requires only a 12-Volt connection for power • Functions as either a dual flash strobe or a quad flash strobe • Lamps fit 4-inch standard mountings • Lamps mount in any orientation • Grote's rugged Plug-and-Go® terminals make for a quick, easy connection every time

77351 Clear
77352 Red
77353 Yellow
77355 Blue

Class: II - Red, Yellow; III - Blue
 Material: Polycarbonate / Acrylic
 Finish: Clear / Red / Yellow / Blue
 Volts / Amps: 12V / .25A
 Bracket: 43253, 92510, 92512, 92513, 43572, 43642, 43655
 Grommet: 91740, 91950
 Pigtail: 66815, 66841, 67002, 66842, 67013, 66816, 66845, 67005, 66823, 66830, 67016, 66846

4" LED STROBE LAMP IN RUBBER HOUSING

Durable rubber lamp housings • Versatile mounting (hardware included)
 • Molded UBS .180 bullet terminals • Pre-wired for quad or dual flash

77192 Red
77193 Yellow

Class: II - Red, Yellow; III - Blue
 Material: Rubber / Polycarbonate / Acrylic
 Finish: Black / Red / Yellow
 Volts / Amps: 12V / .25A
 Accessory: Lamp: Red 77352, Yellow 77353, Blue 77355, Clear 77351;
 Housing: 64930; Magnet Mount: 43300

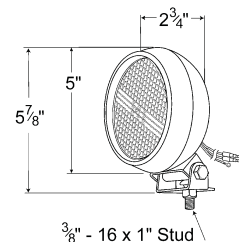

OVAL LED STROBE LIGHTS

Encapsulant potting offers maximum protection of the circuit board against dirt, moisture and corrosion • Internal circuitry eliminates the need for an external power supply or control module • Requires only a 12-Volt connection for power • Functions as either a dual flash strobe or a quad flash strobe • Lamps fit oval standard mounting holes • Lamps mount in any orientation • Grote's rugged Plug-and-Go® terminals ensure quick, easy connections every time

77361 Clear
77362 Red
77363 Yellow
77365 Blue

Class: II - Red, Yellow (quad); III Blue, Yellow (dual)
 Material: ABS / Acrylic
 Finish: Clear / Red / Blue
 Volts / Amps: 12V / .25A
 Bracket: 43362, 43952, 43220, 43223, 43222, 43100
 Grommet: 92420, 92720
 Pigtail: 66815, 66841, 67002, 66842, 67013

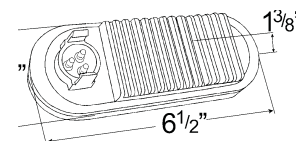

HIGH PROFILE SMART STROBE® LAMP

Die-cast aluminum base with a smooth surface outer dome that protects the inner lens • Field-selectable double or quad flash settings • Voltage-, spike- and surge-protected • 7 support points of contact on the circuit board mounting reduce the damage caused by vibration • Ideal for light- and heavy-duty applications • Field-replaceable flash tube • Smart Strobe® automatically adjusts intensity based on ambient lighting

77453 Yellow

Class: II
 Material: Polycarbonate, Aluminum
 SAE: J845
 Finish: Silver
 Volts / Amps: 12V / 2.1A Hi Intensity Mode
 Volts / Amps: 12V / 1.6A Low Intensity Mode
 Volts / Amps: 24V / 1.0A Hi Intensity Mode
 Volts / Amps: 24V / .8A Low Intensity Mode
 Accessory: Flash Tube: 92970
 Lens: Interior: Yellow 92993; Exterior: Clear 90191

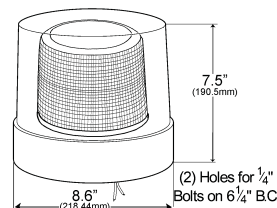

Warning and Hazard

Gyrophares et Feux d'Avertissement Lámparas de advertencia y precaución

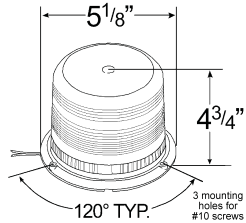

LOW PROFILE STROBE

Three wire leads allow user to choose double flash or quad flash

- Field-replaceable flash tube
- Heavy-duty epoxy filled, reinforced nylon base
- UV stabilized polycarbonate thread-on lens allows user to change the flash tube without tools
- Voltage-spike and surge-protected
- 80 (double) or 65 (quad) flashes per minute

77583 Yellow ● **new**

Class: II
Material: Glass Filled Nylon / Polycarbonate
SAE: J1318
Finish: Yellow / Black
Volts / Amps: 12V - 48V / 1.5A
Accessory: Flash Tube: 92790
Lens: Yellow 92993, Blue 92995; Dust Cover 93691

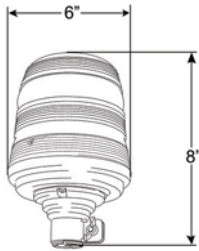

FLEXIBLE-BASE STROBE LAMP

DIN fixing allows product to be quickly installed or moved with use of mounting stems

- 75 flashes per minute (double flash), 7 joules
- Flexible rubber stem allows for 30° angle deflection
- Shock-absorbing features make this lamp suitable in rugged applications, such as on forestry, agricultural and industrial vehicles
- Robust polycarbonate thread-on lens is secured with a single set-screw
- Corrosion-resistant materials
- Mounting stems ordered separately

76963 Yellow ●

MOUNTING HARDWARE:

- 43665** Mounting Stem Only
- 80-1400** Mounting Stem (T-Bracket)
- 80-1401** Adjacent Mounting Stem (L-Bracket)

Class: II
Material: DURAMOLD® / Polycarbonate
Finish: Yellow / Black
Volts / Amps: 12V - 48V / 1.5A
Accessory: Flash Tube: 92970
Lens: Yellow 93383

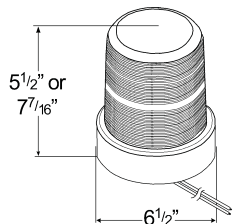

J-BOLT MOUNTING STROBE LAMP

Same look and mounting style as competitive models

- Thread-on lens for easy maintenance
- Vibration resistant
- 5 joules per flash in single flash / 7 joules per flash in double flash
- 80 flashes per minute

77503 Yellow, Low-Profile ●
77603 Yellow, High-Profile ●

Class: II
Material: Aluminum / Polycarbonate
SAE: J1318
Volts / Amps: 12V - 48V / 1.5A at 12V
Accessory: Flash Tube: 92970
Lens: Low-Profile - Yellow 92993; High-Profile - Yellow 93003; Magnetic Mount Base: 43610

LOW-PROFILE HEAVY-DUTY SMART STROBE®

Popular with school buses and construction equipment • 2 mounting options: external and 1" pipe • Field-selectable double or quad flash and intensity • Epoxy version has a potted circuit board for added protection against vehicle vibration and road shock • Smart Strobe® flash intensity automatically adjusts for day and night working conditions • Thread-on lens • Joules: Class I 15 / 20; Class I, Smart Strobe® 10 / 20; Class II 8 / 17 • Flashes per minute: Class I 65 / 80; Class II 60 / 65 • Class I strobes have an LED alert for flash tube failure (does not apply to Class II heavy-duty lamps)

CLASS I, SMART STROBE®:

- 77632** Red ●
- 77633** Yellow ●
- 77635** Blue ●

CLASS I:

- 77611** Clear ●
- 77612** Red ●
- 77613** Yellow ●
- 77615** Blue ●

CLASS II, EPOXY BASE:

- 77622** Red ●
- 77623** Yellow ●
- 77625** Blue ●

CLASS II, HEAVY DUTY:

- 77691** Clear ●
- 77692** Red ●
- 77693** Yellow ●
- 77695** Blue ●

Class: I: 77623, II: 77622, 77625
 Material: Die-Cast Aluminum / Polycarbonate
 Finish: Clear / Red / Yellow / Blue
 SAE: J1318
 Volts / Amps: 12V - 24V / 2.3A - 2.9A at 12V
 Accessory: Flash Tube 92970; Branch Guard 43910
 Lens: Clear 92991, Red 92992, Yellow 92993, Blue 92995, Dust Cover: Clear 93691

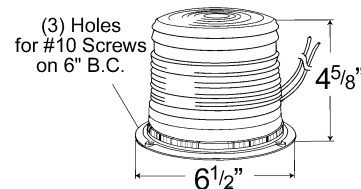

LOW PROFILE PLASTIC BASE STROBE

Fresnel lens provides 360° coverage • Includes 1" pipe mount and flange mount • Choose double or quad flash • 7 joules (double) 10 joules (quad) • Flashes per minute: 80 double; 65 quad • Reverse polarity-, voltage-, and surge-protected

- 77121** Clear ●
- 77123** Yellow ●

Class: II
 Material: Polycarbonate
 Finish: Clear / Yellow / Black
 SAE: J1318
 Volts / Amps: 12V - 48V / 1.5A at 12V
 Accessory: Flash Tube: 92970
 Lens: Yellow 92993; Dust Cover: Clear 93691

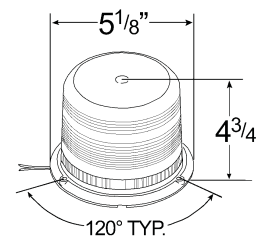

Warning and Hazard

Gyrophares et Feux d'Avertissement Lámparas de advertencia y precaución

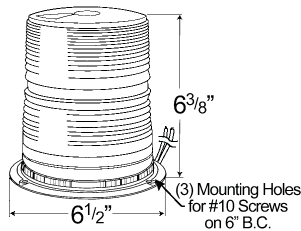

MEDIUM-PROFILE HIGH-INTENSITY SMART STROBE®

Popular with maintenance and utility vehicles • Rugged, coated die-cast base • 2 mounting options: external and 1" pipe • Joules: Class I 15 / 20; Class II, Smart Strobe® 10 / 20; Class II 8 / 17 • Flashes per minute: Class I 65 / 80; Class II 60 / 65 • Smart Strobe® flash automatically adjusts for day or night work conditions • Thread-on lens • Class I has an LED indicator alert for flash tube failure (does not apply for Class II heavy-duty lamps) • Epoxy version has a potted circuit board for added protection against vehicle vibration and road shock • Field-selectable double or quad flash and intensity

CLASS I, SMART STROBE®:

77652	Red
77653	Yellow
77655	Blue

CLASS I:

77641	Clear
77642	Red
77643	Yellow
77645	Blue

CLASS II, EPOXY BASE:

77662	Red
77663	Yellow
77665	Blue

CLASS II, HEAVY-DUTY:

77711	Clear
77712	Red
77713	Yellow
77715	Blue

Material: Die-cast Aluminum / Polycarbonate

Finish: Red / Yellow / Blue / Clear

SAE: J1318

Volts / Amps: 12V - 24V / 2.3A - 2.9A at 12V

Accessory: Flash Tube 92970; Branch Guard 43550

Lens: Clear 93001, Red 93002, Yellow 93003, Blue 93005; Dust Cover: Clear 93701

HIGH PROFILE HIGH-INTENSITY SMART STROBE®

Rugged die-cast base specifically designed for vibration resistance and heat dissipation • Optional: clear lens, dust cover • 2 mounting options: external and 1" pipe • Field-selectable double or quad flash and intensity • Flashes per minute: Class I 80 / 65 Double / Quad; Class II 65 / 60 Double / Quad • Thread-on lens • Smart Strobe® flash automatically adjusts for day or night work conditions • LED Indicator alert for flash tube failure on 7767X Class I strobes

CLASS I, SMART STROBE®:

77682	Red
77683	Yellow
77685	Blue

CLASS I:

77671	Clear
77672	Red
77673	Yellow
77675	Blue

CLASS II

77732	Red
77733	Yellow
77735	Blue

Class: J1318, Class I or II

Material: Die-cast Aluminum / Polycarbonate

Finish: Clear / Red / Yellow / Blue

Volts / Amps: 12V - 24V / 2.3A - 2.9A at 12V

Accessory: Flash Tube 92970; Branch Guard 99490

Lens: Clear 93001, 93002 Red, Yellow 93003, Blue 93005; Dust Cover: Clear 93701

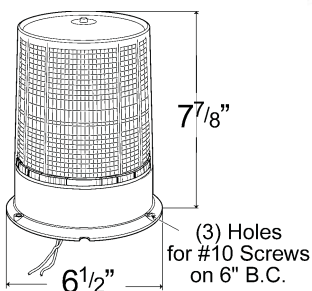

MEDIUM-PROFILE 360° STROBE HEAD

Three mounting options: integral external, internal and 1" pipe mounting
 • Packard connection harness • Separate power supply required

77743 Yellow ●

Class: II
 Material: Aluminum / Polycarbonate
 Finish: Yellow
 SAE: J1318
 Volts / Amps: 12V - 24V / 2.6A at 12V
 Accessory: Power Supply: Two-Head 99880, Four-Head 99850; Cables: 15' 67070, 35' 67061; Flash Tube: 44601

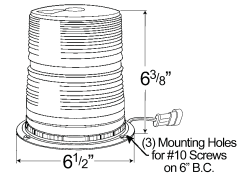

MEDIUM-PROFILE PLASTIC-BASE STROBE

Includes 1" pipe-mount and flange-mount • Choose double or quad flash
 • Reverse polarity-, voltage- and surge-protected • 80 flashes per minute (double); 65 flashes per minute (quad)

77133 Yellow ●

77593 Yellow, Epoxy Base ●

Class: II
 Material: Polycarbonate
 Finish: Yellow
 SAE: J1318
 Volts / Amps: 12V - 48V / 2.3A max
 Accessory: Flash Tube: 92970
 Lens: Yellow 93003; Dust Cover: Clear 93701

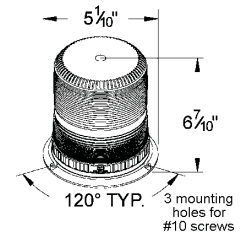

MIGHTY MINI LED STROBES

Rated life of LED strobes is up to 100 times longer than standard strobes
 • SignalAlert™ provides greater visibility by creating a varied flash pattern (vs. standard strobes with a consistent flash pattern) • Exclusive side emitting LED technology rivals standard strobe intensity with a single super LED diode • LED beacon design internally houses the flash control, eliminating the need for an external power supply or ballast • 90 flashes per minute

PERMANENT MOUNT:

77473 Yellow

MAGNET MOUNT WITH CIGARETTE LIGHTER ADAPTER:

77483 Yellow

Class: III
 Material: Polycarbonate
 Finish: Yellow / Black
 Volts / Amps: 12V / .15A
 Lens: Yellow 93723

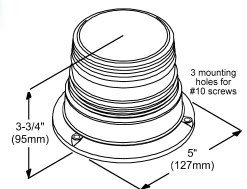

LED MATERIAL-HANDLING BEACON

LEDs use 1/4 the power of a standard strobe, putting less drain on batteries and other power sources • LEDs are a long life, reduced cost solution to frequent replacement of flash tubes • Electronics are fully potted to provide protection against the elements and vibration • 60 flashes per minute
 • Dual LEDs provide extra visibility • Single-flash pattern

77443 Yellow

Material: Polycarbonate
 Finish: Yellow Black
 Volts / Amps: 9V-80V / .13A at 12V / 1.5-Watt

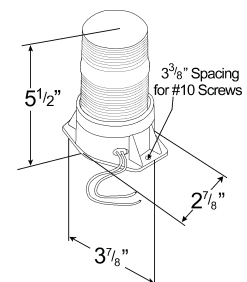

Warning and Hazard

Gyrophares et Feux d'Avvertissement L mparas de advertencia y precauci n



TWO-HEAD OVAL REMOTE STROBE KIT

Double or quad flash options enhance rear vehicle warning • 60 flashes per minute • Package includes: 1 power supply 99880, 2 oval strobes 77263, 2 35' cable 67061, 1 rocker switch 44870-5 and 2 oval grommets 92420

52010 Yellow, Strobe Lamp Kit

Class: I
Volts / Amps: 12V - 24V / 4.5A max

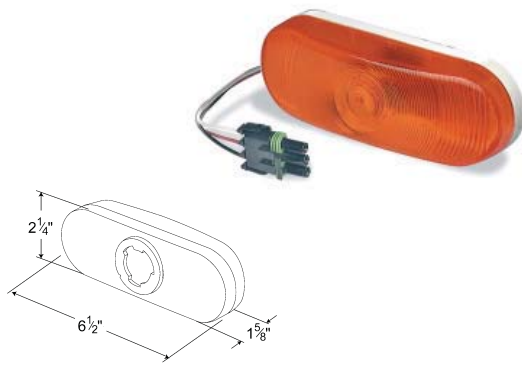

OVAL STROBE HEAD

Twist-in socket design for flash tube replacement • Vibration- and shock-resistant construction • Polycarbonate lens and base

77263 Yellow

Material: Polycarbonate
Finish: Yellow / White
Volts / Amps: 12V - 24V / 2.25A at peak
Accessory: Flash Tube / Pigtail: 92820; Cable Assembly: 15' 67060, 35' 67061
Bracket: 43100, 43362
Grommet: 92420, 92720

LED

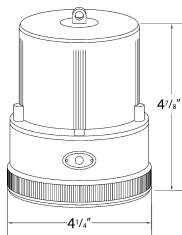

360° PORTABLE BATTERY OPERATED LED WARNING LIGHT

24 ultra-bright LEDs help conserve battery life • 300 - 400 hours of operation on 2 D batteries (not included) • 60 triple flashes per minute • Strong magnet base holds lamp in place on a metal surface • Photocell adjust intensity for low light situation

77912 Red **new**
77913 Yellow **new**

Material: Nylon / Polycarbonate
Finish: Red / Yellow
Bracket: 96010

LED

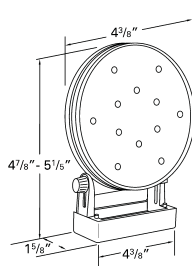

DIRECTIONAL, PORTABLE, BATTERY-OPERATED LED WARNING LIGHT

Push-button operation • 72 hours of operation on 2 AA Batteries (not included) • Includes a magnetic base and is adjustable 180° • Additional reflective lens as added safety feature • 3 user-selectable flash patterns

77923 Yellow **new**

Material: Nylon / Polycarbonate
Finish: Yellow

LED DASH / DECK LIGHT

Dash-mount, pint-sized light that throws a full-sized punch • High-output, GEN3 LED technology produces incredible high intensity warning in a compact design that fits easily and snugly to the windshield • Each light provides multiple Scan-Lock™ flash patterns and includes an 8-foot cord with accessory plug, on / off switch and LED "on" indicator

- 76552** Red new
- 76553** Yellow new
- 76554** Green new

Class: I (Red and Amber)
 Material: Polycarbonate
 SAE: J845 (76552 / 76553)
 Finish: Black
 Volts / Amps: 12V / .6A solid / .3A split

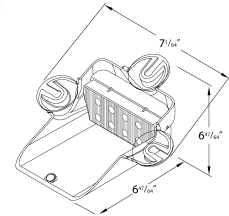

HIGH INTENSITY LED DIRECTIONAL LIGHT SURFACE MOUNT

Utilizes four high intensity 1-Watt Luxeon® LEDs and ribbed optics for maximum light dispersion • User selectable steady burn, double, quad, or quint flash modes • 74 FSPM in double, quad and quint modes

- 77763** Yellow new

Class: I
 Material: Aluminum / Acrylic
 SAE: J845 (Quad mode only)
 Finish: Clear
 Volts / Amps: 12V / .3A

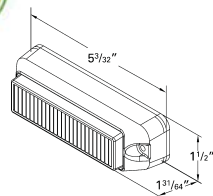

HIGH-OUTPUT LED DIRECTIONAL LIGHT SURFACE OR GROMMET MOUNT

42 individual 1/4-Watt LEDs with individual reflectors • Tough, clear polycarbonate housing with urethane encapsulated electronics • 75 to 80 flashes per minute

- 77773** Yellow new

Class: I
 Material: Polycarbonate
 SAE: J845
 Finish: Clear
 Volts / Amps: 12.8V / .90A
 Bracket: 93960
 Grommet: 92420, 92720; Grommet Adaptor: 93960

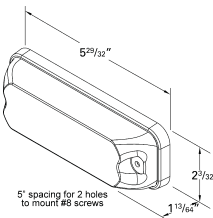

LED DIRECTIONAL WARNING LAMP

Versatile LED directional warning light can be synchronized with up to 8 interconnected modules and 25 different built-in flash patterns • Fully-encapsulated, sturdy polycarbonate construction coupled with a dependable gasket design ensures superb moisture and vibration resistance • Self-contained high-intensity, wide-angle LED module • Horizontal / vertical surface mount

- 77461** Clear new
- 77462** Red new
- 77463** Yellow new

Class: I
 Material: Polycarbonate / Aluminum
 SAE J595 and J845
 Finish: Clear
 Volts / Amps: 12V / .40A Peak
 Volts / Amps: 12V / .16A Average
 Bracket: 94652, 94662

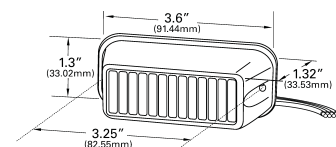

Warning and Hazard

Gyrophares et Feux d'Avvertissement L mparas de advertencia y precauci n

LED



97942 Flange

97943 Flange

LED VERTEX™ HIDEAWAY STROBE LAMP

Ultra small, self-contained, hemispheric LED light for surface mount or internal mount within composite headlight, cornering lights and taillight assemblies • Flange kit options (in black or chrome) allow easy surface mounting anywhere on your vehicle • 25 Scan-Lock™ flash patterns include a synchronize feature for alternating and synchronous flashing of multiple lamps • Simple installation: with no separate lamp drivers, flashers, ballast or power supplies to install

77931	Clear	new
77932	Red	new
77933	Yellow	new
77935	Blue	new

Class: 5
Material: Polycarbonate / Aluminum
SAE: J1113-41
Finish: Clear, Red, Yellow, Blue
Volts / Amps: 10V -16V
Flange: Chrome 97942, Black 97943

LED

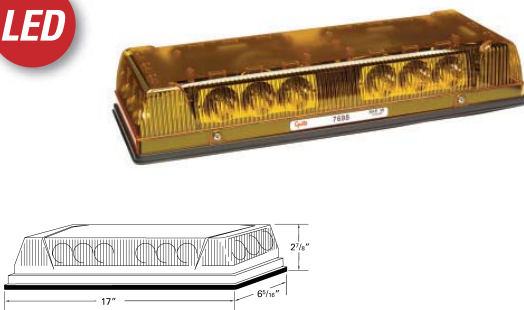

LOW-PROFILE LED MINI LIGHT BAR

Low profile provides high performance characteristics of LED lighting in a small size • 6 internal LED modules provide 360° light output • Built-in electronic flasher with 30 Scan-Lock™ flash pattern plus 4 simulated rotating patterns (permanent-mount version only) • Permanent mount includes 6" pigtail; magnetic mount includes 8' straight cord with accessory plug that includes LED indicator switch • Permanent mount on 14 1/6" x 3 7/16" hole centers • Mounting hardware and instructions included

76983	Yellow, Permanent Mount	new
76993	Yellow, Magnet Mount	new

Class: I
Material: Polycarbonate
SAE: J845
Finish: Yellow
Volts / Amps: 12V / 3A (peak) / 1.2A (avg.)

MULTI-HEAD LED CLEAR BAR LAMP

Permanent mount (includes accessory plug with built in on / off switch)
 • High-intensity LEDs provide unrivaled warning • Two configurations:
 6-head (76602 and 76603 and 8-head (76612 and 766132)

6-HEAD:

- 76602** Red new
- 76603** Yellow new

8-HEAD:

- 76612** Red new
- 76613** Yellow new

Class: I
 Material: Polycarbonate
 SAE J845
 Finish: Clear / Red / Yellow
 76602/3 Volts / Amps: 12V / 2.94A / 43-Watt
 76612/3 Volts / Amps: 12V / 3.08A / 43-Watt

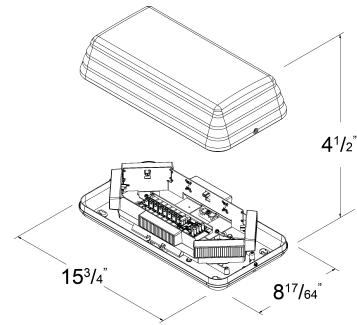

23" LED BAR LAMP

Low-profile design, only 2 1/4" high by 12" wide, reduces air drag and provides the popular stealth appearance to your vehicle • 95 Scan-Lock™ flash patterns • Clear polycarbonate lenses feature a moisture-resistant compression-fit gasket • Sturdy black polycarbonate base on an extruded aluminum platform will not bend • To access the light bar for service or upgrade, simply remove four screws • Replace any light head by removing one screw and a single connector

- 77003** Yellow new

Class: I
 Material: Polycarbonate / Aluminum
 SAE J845
 Finish: Clear
 Volts / Amps: 12V / 2A

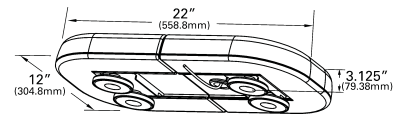

COMPACT STROBE LAMP

Compact, low-profile design • Hi / Lo intensity • Field selectable dual (70) or quad (65) flash • Reverse polarity-, voltage-, spike- and surge-protected

- 77753** Yellow ●

Class: II
 Material: Polycarbonate
 SAE: J1318
 Finish: Black / Yellow
 Volts / Amps: 12V - 24V / 3.8A at 12V
 Accessory: Flash Tube: 92970; Vacuum / Magnet Mount Kit: 43090
 Lens: Outer: Yellow 93443, Blue 93445

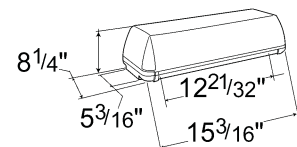

Warning and Hazard

Gyrophares et Feux d'Avertissement Lámparas de advertencia y precaución

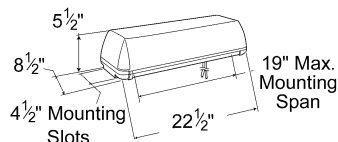

22" ROTATING EMERGENCY WARNING BAR

Gear-driven versions have a self-lubricating, heavy-duty motor and gear assembly • Belt-driven versions have a silicon belt and stainless-steel bearings for long life; belt is resistant to heat and UV light damage • Dual rotating reflectors • Full diamond mirror provides more flashes to front and rear for added visibility • 400 flashes per minute • Rugged, extruded aluminum base

77153 Yellow, Gear Drive

77173 Yellow, Belt Drive

Class: I

Material: Aluminum / Polycarbonate

SAE: J845

Finish: Yellow

Bulb: (2) 795 Volts / Amps: 12V / 8.8A

Accessory: Bulb: Halogen 90900; Motor: Gear-Driven 99260, Belt-Driven 99370

Lens: Red 92872, Yellow 92873

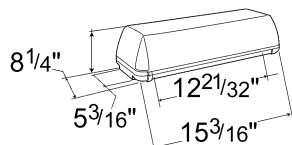
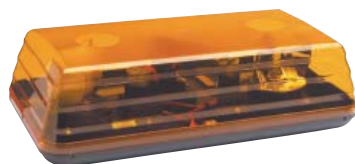

15" ROTATING LOW PROFILE, EVOLUTION® STYLE BAR LAMP

Permanent-mount hardware included • Dual belt drive rotators • 55-Watt halogen bulbs • 480 flashes per minute • Sleek, low-profile lens design • Silicon belt and stainless-steel bearings for long life; belt is resistant to heat and UV light damage

76813 Yellow

Class: I

Material: Polycarbonate

SAE: J845

Finish: Yellow / Black

Bulb: H1, 55-Watt Volts / Amps: 12V / 10.5A

Accessory: Motor: Belt Drive 99370; Belt: 99250, Bulb: 90620;

Vacuum / Magnet Mount Kit: 43090

Lens: Yellow 93443, Blue 93445

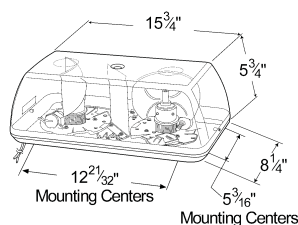

ROTATING 15" HI-INTENSITY MINI-BAR

Gear-driven versions have a self-lubricating, heavy-duty motor and gear assembly • Belt-driven versions have a silicon belt and stainless-steel bearings for long life; belt is resistant to heat and UV light damage • Halogen bulbs • 300 flashes per minute • Separate magnetic mount kit available • Dual rotating reflectors with fixed mirrors

GEAR DRIVE:

76802 Red
76803 Yellow
76805 Blue
77373 Yellow w / Clear Dome
76473 Yellow, 24-Volt

BELT DRIVE:

77163 Yellow
77165 Blue

MOUNTING OPTIONS:

43240 Magnetic Mounting Kit
43090 Vacuum Mounting Kit **new**

Class: I

Material: Polycarbonate

Bulb: (2) 90900 50-Watt Volts / Amps: 12V / 8.8A

Bulb: (2) 90901 50-Watt Volts / Amps: 24V / 4.1A

Accessory: Motor: Gear Driven 99260, Belt Driven 99370; Belt 99250

Bulb: Halogen 90900, 24V 90901; Replacement Mirror: 99230

Lens: Yellow 92883, Blue 92885

15" ROTATING HI-INTENSITY PORTABLE MINI BAR

Dual rotating reflector with fixed mirrors • Vacuum / magnetic mount rated to 65 mph • Two factory-installed vacuum magnets and 17' cord with cigarette lighter plug switch • Two 50-Watt, halogen bulbs with 300 flashes per minute in rear and front • Self-lubricating, heavy-duty motor and gear assembly • Magnet mount for use only when vehicle is stationary

VACUUM / MAGNET MOUNT:
76923 Yellow

MAGNET MOUNT:
76933 Yellow
76935 Blue

Class: I
 Material: Polycarbonate
 Finish: Yellow / Blue
 SAE: J845
 Bulb: (2) 795, 50-Watt Volts / Amps: 12V / 8.8A
 Accessory: Bulb: Halogen 90900, Motor: Gear Driven 99260, Vacuum / Magnet Mount Kit: 43090
 Lens: Yellow 92883, Blue 92885, Clear 92881, Red 92882

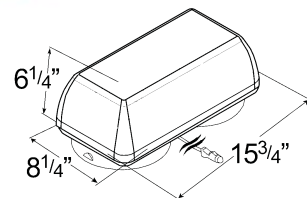

360° MINI-BAR STROBE

Dual alternating strobe lights with a fixed center mirror • Three-wire lead allows double / quad flash function • Flashes per minute: 80 double, 65 quad • 14 joules (double), 20 joules (quad) • Clear lens with two yellow strobes

15" STROBE BAR:
77703 Yellow

22" STROBE BAR:
77723 Yellow

Class: II
 Material: Polycarbonate
 Finish: Yellow
 Volts / Amps: 12V - 48V / 3A at 12V
 Accessory: Flash Tube: 92970, Vacuum / Magnet Mount Kit: 43090
 Lens: Inner - Yellow 92993
 Outer - 15" Clear 92881; 22" Clear 92871

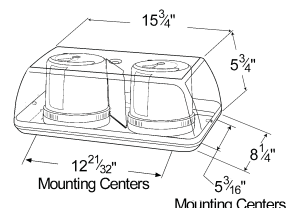

54" "WRECKER'S SPECIAL" LIGHT BAR

55-Watt flood lamps • Rear brake / tail function • Mounts to tow-truck pylon • 50-Watt, halogen warning lamps • Simple dome removal

76903 Yellow

Class: I
 Material: Aluminum / Polycarbonate
 Finish: Clear / Yellow
 Bulb: Warning: (3) 795 Volts / Amps: 12V / 13.2A
 Bulb: S / T / T: (2) 1157 Volts / Amps: 12V / 4.2A
 Bulb: Work lights: (2) 90861-5 Volts / Amps: 12 V - 8.6 A
 Accessory: Bulb: Halogen 90900; Motor: Gear-Driven 99260;
 Lamp: S / T / T Red 53132; Work lamp Kit: Clear 64451-5 (Pair)
 Lens: Center: Yellow 93373; Outer: Clear 93361
 Clear Baffle: 93881; Yellow Baffle- 93883

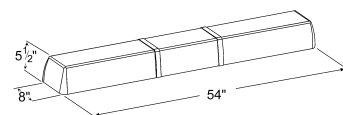

Warning and Hazard

Gyrophares et Feux d'Avertissement Lámparas de advertencia y precaución

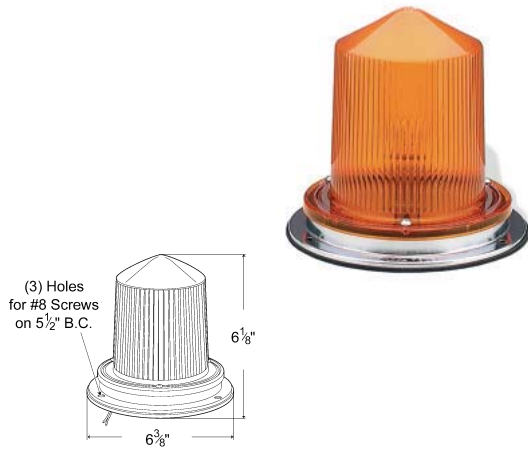

ECONOMY 360° FLASHING AUXILIARY WARNING LAMP KIT

For use when maximum warning is not required • Bright chrome-plated steel weather-proof base • 60-90 flashes per minute • Flasher can be bypassed for steady burn

76082	Red
76083	Yellow
76085	Blue

Material: Steel / Acrylic
 Finish: Red / Yellow / Blue / Chrome
 Bulb: 1295, 50 CP Volts / Amps: 12V / 3.0A
 Lens: Red 90352, Yellow 90353, Blue 90355



LED SAFETY DIRECTOR DIRECTIONAL LIGHT

Extruded aluminum housing and clear polycarbonate LED module (illuminates yellow) • Epoxy-sealed electronics provide maximum environmental protection • Wigwag and alternating flash patterns • 35-foot cable length

78473 Yellow **new**

Class: I
 Material: Aluminum / Polycarbonate
 SAE: J845
 Finish: Clear / Black
 Volts / Amps: 12V / 7A



DIRECTIONAL ARROW AND CONTROL

Compact control head provides in-cab feedback of arrow pattern on an LED display • Rugged extruded aluminum housing • Flash right, flash left, center out and wigwag patterns • Will mount on most bar lights

INCANDESCENT:

78260 Signal and Control Head w / 15' Harness

HALOGEN:

78980 Signal and Control Head w / 35' Harness

78360 Signal and Control Head w / 15' Harness

Class: II
 Material: Aluminum / Acrylic
 SAE: J845 / J575
 Finish: Black / Yellow
 Bulb: 78260: 1156 Volts / Amps: 12V / 18A max
 Bulb: 78980: 795 Volts / Amps: 12V / 20A max
 Accessory: Bulb: Halogen 90900; Power Module: 87800

ALTERNATING "X" PATTERN LED STROBE LAMP KIT

Lamp flashes in an alternating "X" pattern • LED lamps pull fewer amps
 • System can be wired so the lamps operate as turn signal lamps when the turn signal is activated; then return to strobe function when turn signal is canceled • System uses sealed UBS wiring and LED lamps to maximize protection from moisture and corrosion • Kit contains necessary grommets, pigtails and installation instructions • Ideal for refuse vehicles and highway- maintenance equipment • Four-lamp system has two oval and two round lamps; six-lamp system has two oval and four round lamps

- 99630** Strobe Power Module
- 65132** Yellow, 4-Lamp System
- 65130** Yellow, 6-Lamp System

Class: II Strobe Function Only
 Material: Polycarbonate
 Finish: Yellow / Black
 Volts / Amps: 65132 - 12V / .6A
 Volts / Amps: 65130 - 12V / .96A
 Accessory: Lamp: 4" Round - Yellow 53413; Oval - Yellow 53963
 Grommet: Round 91740; Oval 92420
 Pigtail: 66815

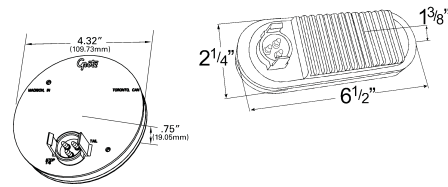

TWO SEALED-BEAM ROTO-BEACON

Clutched gear box is sealed and permanently lubricated • Revolves 360°, 60 to 120 flashes per minute

12 VOLT:	
76222	Red
76223	Yellow
76225	Blue
76333	Yellow w / Polycarbonate Lens

24 VOLT:	
76283	Yellow ●
76285	Blue (Long lead time item) ●

Class: I: Red, Yellow; II: Blue
 Material: Stainless-Steel, Aluminum / Acrylic, Polycarbonate
 Finish: Red / Yellow / Blue
 Bulb: 7400 SB; 33,000 CP Volts / Amps: 12V / 5.9A
 Bulb: 4505; 45,000 CP Volts / Amps: 24V / 3.9A
 Bracket: 76121
 Lens: Red 90372, Yellow 90373, Blue 90375; Polycarbonate: Yellow 91323

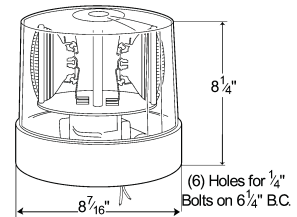

COMPACT FOUR SEALED-BEAM ROTO-BEACON

Clutched gear box design and "suitcase" latch design • Permanently lubricated, sealed gear box • Revolves 360°, 60 to 120 flashes per minute

- 76203** Yellow
- 76205** Blue

Class: I: Yellow; II: Blue
 Material: Stainless-Steel, Aluminum / Acrylic
 SAE: J845 / W
 Finish: Yellow / Blue
 Bulb: 7400 SB, 33,000 CP Volts / Amps: 12V / 11.7A
 Accessory: Branch Guard: Black 99490
 Bracket: 76121 Lens: Red 90372, Yellow 90373, Blue 90375, Clear 90371;
 Polycarbonate: Yellow 91323

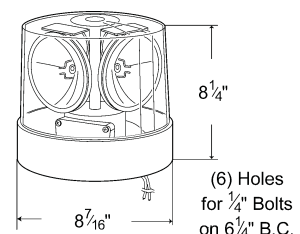

Warning and Hazard

Gyrophares et Feux d'Avertissement Lámparas de advertencia y precaución

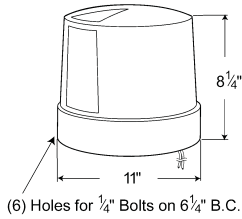

FOUR SEALED-BEAM ROTO-BEACON

Clutched gear box is sealed and permanently lubricated • Revolves 360°, 60 to 120 flashes per minute

76243 Yellow

Class: I
SAE: W
Material: Stainless-Steel / Aluminum / Acrylic
Finish: Yellow
Bulb: 7400 PAR 36; 33,000 CP Volts / Amps: 12V / 11.7A
Bracket: 76121
Lens: Yellow 90363

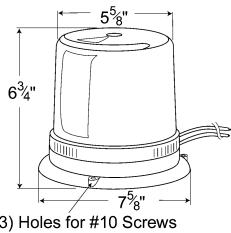

ROTATING BEACON LIGHT

Self-lubricating heavy-duty motor and gear assembly • Thread-on lens for easy maintenance • Durable, three-point rotating assembly dissipates shock • Non-corrosive base • 50-Watt halogen bulb; 100 flashes per minute • Permanent mount hardware included

PERMANENT MOUNT:

76462 Red
76463 Yellow
76465 Blue

VACUUM / MAGNET MOUNT W / SWITCHED 17' LIGHTER PLUG CORD:

76483 Yellow

Class: I
Finish: Red / Yellow / Blue
Material: Polycarbonate
SAE: J845
Bulb: 795, 50-Watt Volts / Amps: 12V / 4.4A
Accessory: Bulb: 90900; Motor: Gear Driven 99260
Lens: Red 92832, Yellow 92833, Blue 92835

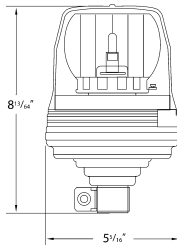

STEALTH LOW-PROFILE STROBE LIGHT

Durable belt-drive rotator • 160 flashes per minute • Thread-on lens is secured quickly with a single screw • Quick-connect base allows for easy installation and removal

76493 Yellow **new**

Class: I
Material: ABS / Polycarbonate
SAE: J845
Finish: Black / Yellow
Bulb: H1, 55-Watt Volts / Amps: 12V / 5.2A
Accessory: Flash Tube 90620; Mounting Brackets: 43665, 80-1401, 80-1400

FLUSH-MOUNT ROTATING BEACON

Flush-mount European-style beacon • E-mark approval • Belt drive with stainless-steel bearings • 160 flashes per minute • Thread-on lens, quickly secured with a single screw • Magnet mount versions include 15' coiled cord w / lighter plug

PERMANENT MOUNT:

- 76043** Yellow
- 76063** Yellow, 24 Volt

MAGNETIC MOUNT W / 15' SWITCHED LIGHTER PLUG CORD:

- 76053** Yellow

Class: I
 Material: DURAMOLD®
 Finish: Yellow / black
 Bulb: H1, 55-Watt (90620) Volts / Amps: 12V / 5.2A
 Bulb: H1, 70-Watt (91051) Volts / Amps: 24V / 2.4A
 Lens: Yellow 93283, Blue 93285

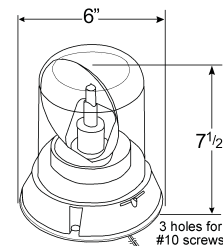

ECONOLITE WITH REVOLVING REFLECTOR

Single 50 CP bulb with rotating parabolic reflector • Compact economy model • 90 to 100 flashes per minute • Separate round steel mounting plate

PERMANENT MOUNT:

- 76162** Red
- 76163** Yellow

MAGNET MOUNT WITH CIGARETTE LIGHTER ADAPTER:

- 76183** Yellow w / 10' cord
- 76185** Blue w / 10' cord

Class: III
 Material: Stainless-Steel / Acrylic
 Finish: Red / Yellow / Blue
 Bulb: 1295: 50 CP Volts / Amps: 12V / 3.3A
 Lens: Red 90382, Yellow 90383, Blue 90385

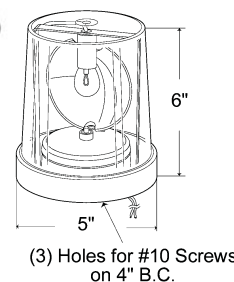

LOW-PROFILE REVOLVING BEACON

Durable belt-drive rotator • 160 flashes per minute • Thread-on lens is quickly secured with a single screw • Flush mount

- 76443** Yellow

Class: I
 Material: ABS / Polycarbonate
 SAE: J845
 Finish: Yellow / Black
 Bulb: H1: 55-Watt Volts / Amps: 12V / 5.2A
 Accessory: Bulb: 90620

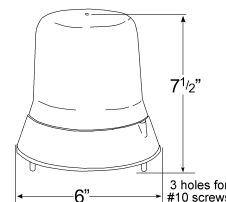

Warning and Hazard

Gyrophares et Feux d'Avertissement Lámparas de advertencia y precaución

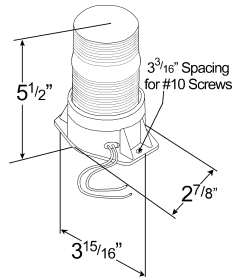

MATERIAL HANDLING STROBE

Electronics sealed in epoxy to protect against dust, moisture and vibration

- Thread-on lens for easy maintenance
- Field-replaceable flash tube
- Meets UL 583 and SAE J1381
- 80 flashes per minute (single flash)
- 2 joules per flash

- 77012** Red ●
77013 Yellow ●
77015 Blue ●

Material: Nylon / Polycarbonate
 Finish: Red / Yellow / Black
 Volts / Amps: 12V - 110V / .6A at 12V
 Accessory: Flash Tube: 92960
 Lens: Yellow 93013, Blue 93015

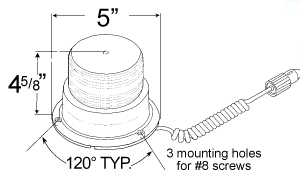

ECONOMY MATERIAL HANDLING STROBE

Thread-on lens for easy maintenance • Polycarbonate lens and fiberglass-filled nylon base • Reverse polarity and voltage spike protected • 45 lbs pull magnet for temporary mounting with 12' adapter plug • 1.5 joules per flash, 70 flashes per minute (single flash) • Replaceable flash tube • Removable 1/2 hood included

- 77203** Yellow ●

Material: Polycarbonate
 Volts / Amps: 12V - 80V / .3A at 12V
 Finish: Yellow / Black
 Accessory: Flash Tube: 92980
 Lens: Yellow 92033

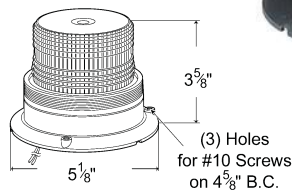

MIGHTY MINI STROBE

Rugged, fiberglass-filled nylon base and polycarbonate lens • Wide voltage operating range • Field-replaceable lens and flash tube • Thread-on lens • 80 flashes per minute; 1.5 joules • Reverse polarity and voltage spike protected

SINGLE FLASH:

- 77101** Clear ●
77102 Red ●
77103 Yellow ●
77105 Blue ●

Material: ABS / Polycarbonate
 Finish: Clear / Red / Yellow / Blue
 Volts / Amps: 11V - 110V / .25A at 12V
 Accessory: Flash Tube: 92980
 Lens: Red 92032, Yellow 92033, Blue 92035, Clear 92031

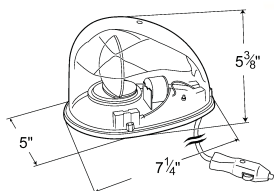

TEARDROP "KOJAK" LIGHT

Low-power consumption light • Cigarette lighter plug with coiled cord • Magnetic mount

- 76032** Red, Retail Pack
76033 Yellow, Retail Pack
76034 Green, Retail Pack
76035 Blue, Retail Pack

Material: Acrylic
 Finish: Red / Yellow / Green / Blue
 Bulb: 67, 4 CP Volts / Amps: 12V / 1.64A
 Accessory: Coil Cord: 87090
 Lens: Red 92452, Yellow 92453, Green 92454, Blue 92455

REPLACEMENT FLASHTUBES

Grote offers several options for replacement flash tubes • See part listing for recommended tube replacement part number

- 92820** W / attached Pigtail
- 92960** 3-Pin, Hard-Shell Connector
- 92970** 3-Pin, Needle Style
- 92980** 3-Pin, Flat Pin Style

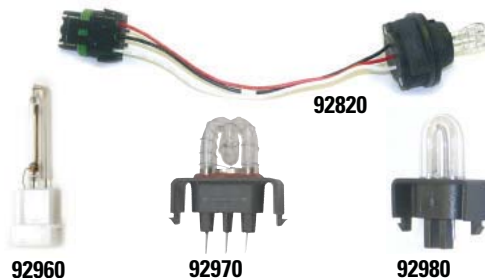

TWO-HEAD STROBE POWER SUPPLY

Two-outlet power supply • Hi / low power control • User-selectable double or quad flash • For use with 7726 models • Each strobe outlet flashes 60 cycles per minute • Alternating pairs outlet flashes 120 cycles per minute • 12- to 24-Volts

99880 2 Head

Material: DURAMOLD®
Volts / Amps: 12V - 24V / 35-Watt

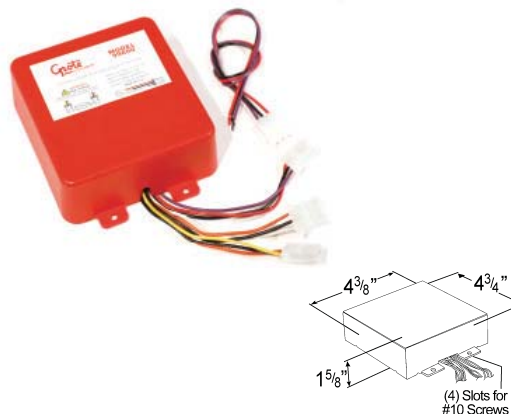

FOUR-HEAD STROBE POWER SUPPLY

Four-outlet power supply • Hi / low power control • User-selectable double or quad flash • For use with 7726 models • Each strobe outlet flashes 60 cycles per minute • Alternating pairs outlet flashes 120 cycles per minute • 12- to 24-Volts

99850 4 Head

Material: Metal
Volts / Amps: 12V - 24V / 60-Watts



STROBE REPLACEMENT ASSEMBLIES

Double-jacketed cable • Packard connection • For use with Grote remote strobe systems

- 67060** 15' Cable
- 67061** 35' Cable
- 99250** Replacement Belt



Warning and Hazard

Gyrophares et Feux d'Avvertissement Lámparas de advertencia y precaución

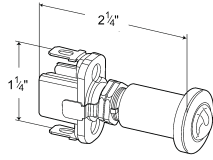

16-AMP ILLUMINATED PUSH-PULL SWITCH

Will handle up to a 4-bulb Roto-Beacon

44170 Switch

Bulb: BA75, 2-Watt Volts / Amps: 12V / .17A

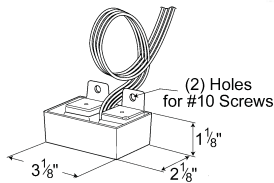

PROFESSIONAL EMERGENCY FLASHER

Wigwag pattern • Hi-beam override • Completely sealed in epoxy potting • Not for use with negative-activation headlight systems

44740 Flasher

Volts / Amps: 12V / 20A max each side

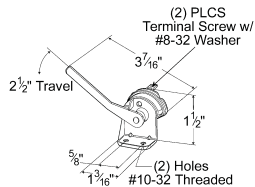

ACTUATION SWITCH

Often utilized with back-up alarms • Activates when shifting into reverse

44134 Switch

Material: Steel
Finish: Zinc Plate
Volts / Amps: 12V - 36V / 5A max

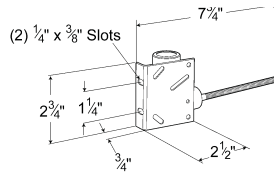

ACTUATION SWITCH

Heavy-duty usage • Mechanical actuation • Includes mounting bracket and weather-proof compression fitting

44421 Switch

Material: DURAMOLD® / Steel
Finish: Zinc
Volts / Amps: 12V - 80V / 10A max

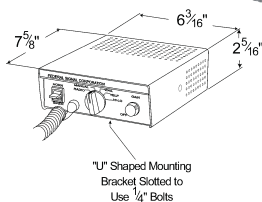

FULL-FEATURED SIREN (POLICE / FIRE PROFESSIONAL)

100-Watt output • Wail / Yelp / Hi-low plus horn • Public address function • Built-in microphone

87781 Black

Volts / Amps: 12V

100-WATT SPEAKER

Mates with Grote Full-Featured Siren (87781) • Outside or concealed mounting • 120 decibels at 10 ft.

87790 Speaker

Volts / Amps: 12V / 3.57A

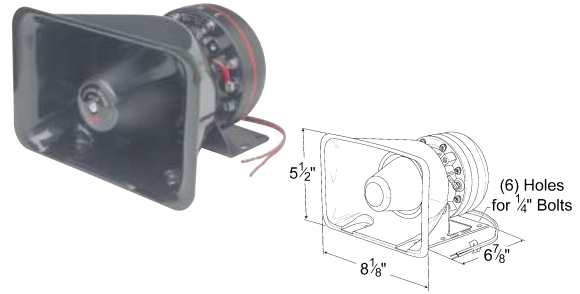

HEAVY-DUTY SMART ALARM® BACKUP ALARM

Electronics sealed in epoxy for protection against dust, vibration and moisture • Measures ambient noise level and instantly self-adjusts to at least 5 decibels louder • Automatically adjusts to eliminate users confusion on which volume to select • Volume 87 to 112 decibels • Universal mount

73080 87 to 112 Decibels, Smart Alarm®

Material: Steel
FMVSS: F
Finish: Blue
Volts / Amps: 12V - 24V / .4A

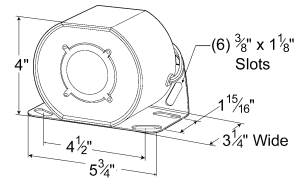

FIELD-SELECTABLE BACKUP ALARM

Electronics sealed in epoxy for protection against dust, vibration, and moisture • Adjusts to SAE type A or B for medium to high noise • 12- to 36-Volts • Selectable volume control, 107 or 112 decibels by reversing the leads • Universal mount

73030 107 or 112 Selectable Decibels

Material: Steel
SAE: J994 Type A or B
Finish: Blue
Volts / Amps: 12V - 36V / .6A at 12V

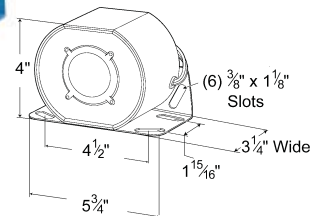

4" GROMMET MOUNTED BACKUP ALARM

Mounts in standard 4" grommet (grommet not included) • Epoxy-sealed to protect against dust, moisture and vibration

73160 112 Decibels

Material: Steel
SAE: J994 Type A
Finish: Black
Volts / Amps: 12V - 36V / .6A at 12V
Grommet: 91740

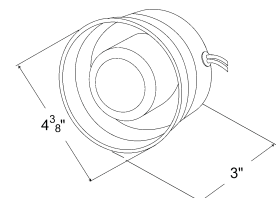

Warning and Hazard

Gyrophares et Feux d'Avertissement Lámparas de advertencia y precaución



4" ECONOMY GROMMET MOUNTED BACKUP ALARM

Features Grote's hard-wired UBS-bullet termination to create a sealed wiring connection • Mounts in standard 4" grommets • Electronics completely encapsulated in potting for total circuit-board protection • Grommet style mounting for added protection against damage and knock-offs from debris

73220 97 Decibels ●

Material: Nylon
SAE: J994 Type C
Finish: Black
Volts / Amps: 12V / .2A
Grommet: 91740
Pigtail: 66200



MEDIUM NOISE SURROUND BACKUP ALARM

Features hard-wire terminations • Integral mounting bracket • Electronics completely encapsulated in potting for total circuit-board protection

73250 107 Decibel ●
73240 82 to 107 Decibels, Smart Alarm® ●

Material: Steel
SAE: J994 73250 - Type B, 73240 - Type F
Finish: Blue
12V - 36V (73250) Volts / Amps: .6A at 12V
12V - 24V (73240) Volts / Amps: .6A at 12V

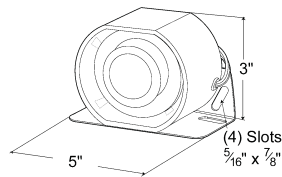

MEDIUM / LOW NOISE SURROUND BACKUP ALARM

Electronics sealed in epoxy for protection against dust, vibration and moisture • Self-grounding, eliminates potential corrosion points
• Universal integral mounting bracket • Voltage-spike and surge-protected • UL Approved

73040 97 Decibels, w / Wire Studs ●
73040-5 97 Decibels, w / Wire Studs, Retail Pack ●
73090 107 Decibel w / Wire Leads ●
73110 92 to 102 Decibels, Smart Alarm® ●

Material: Nylon
SAE: J994: Type B 73090, Type C 73040, Type F 73110
Finish: Blue
Volts / Amps: 12V - 24V / .4A at 12V

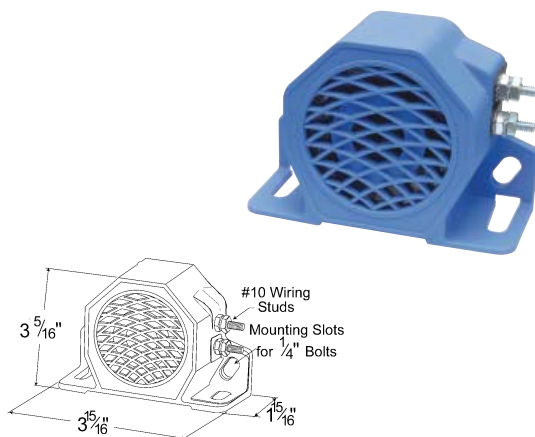

LIGHT DUTY BACKUP ALARM

Universal mounting • Compact size • Not an SAE rated alarm

73120 90 Decibels

73120-5 90 Decibels, Retail Pack

Material: Nylon
Finish: Blue
Volts / Amps: 12V / .2A

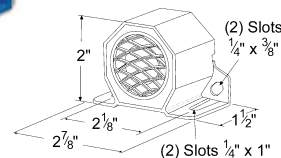

BEEPING BACKUP HALOGEN BULB

Combination back-up safety device and lamp in one • Provides a clear beeping sound when vehicle shifts into reverse gear • Alarm does not meet OSHA or SAE J994 requirements for commercial back-up alarms

BAYONET BASE: (1156 REPLACEMENT)

73140-5 Retail Pack

WEDGE BASE: (3156 REPLACEMENT)

73150-5 Retail Pack

Volts / Amps: 12V / 1.67A

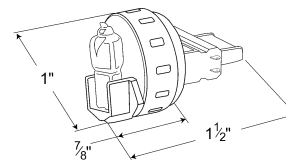

ELECTRIC AUTOMOTIVE HORNS

Complete with mounting bracket

FOR IMPORT VEHICLES:

72010-5 High, 135 Decibels, Retail Pack

72050-5 Low, Retail Pack

FOR DOMESTIC VEHICLES:

72100-5 High, 125 Decibels, Retail Pack

72110-5 Low, Retail Pack

Material: Steel
SAE: J377
Finish: Black Enamel
Volts / Amps: 12V

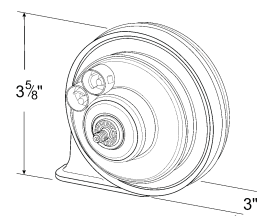

10-LAMP ELECTROMECHANICAL FLASHER

Molded base and terminals • Heavy-duty contacts • 60-120 flashes per minute

2 TERMINAL:

- 44810** Flasher
- 44810-5** Flasher, Retail Pack

3 TERMINAL (PILOT):

- 44820** Flasher

FMVSS: J945, J590
Volts / Amps: 12V / 2A - 20A; Lamp Load: 1-10 lamps
Bracket: 43770



12-LAMP ELECTROMECHANICAL FLASHER

60 to 120 flashes per minute • Available in standard (12-Volt) and 24-Volt models • Less than 4 millivolts per amp voltage drop • Exceeds SAE 100-hour test • Fits in a round flasher socket

2 TERMINAL:

- 44530** Flasher
- 44530-5** Flasher, Retail Pack
- 44850** Flasher, 24-Volt

3 TERMINAL (PILOT):

- 44540** Flasher
- 44540-5** Flasher, Retail Pack
- 44860** Flasher, 24-Volt

FMVSS: J945, J590
Volts / Amps: 12V / 2A - 25A; Lamp Load: 1-12 lamps
Bracket: 43770

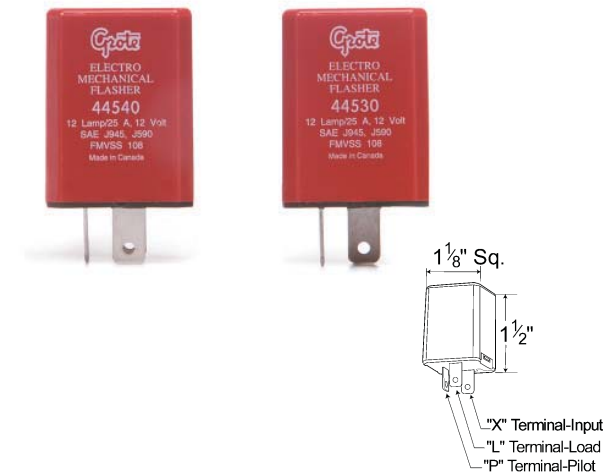

16-LAMP ELECTRONIC FLASHER

60 to 120 flashes per minute • 11- to 15-Volts DC • Less than 4 millivolts per amp voltage drop • Exceeds SAE 100 hour test • Fits in a round flasher socket

2 TERMINAL:

- 44690** Flasher

3 TERMINAL (PILOT):

- 44700** Flasher

FMVSS: J945, J590
Volts / Amps: 12V / 2A - 33A; Lamp Load: 1-16 lamps
Bracket: 43770

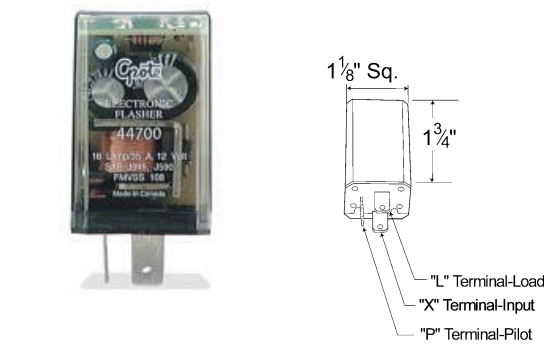

20-LAMP HEAVY DUTY ELECTRONIC FLASHER

60 to 120 flashes per minute • 11- to 15-Volts DC • Less than 3-millivolts per amp voltage drop • Fits standard round socket • Exceeds SAE 100-hour test

2 TERMINAL:

- 44710** Flasher

3 TERMINAL:

- 44720** Flasher

FMVSS: J945, J590
Volts / Amps: 12V / 2A - 42A; Lamp Load: 1-20 lamps
Bracket: 43770

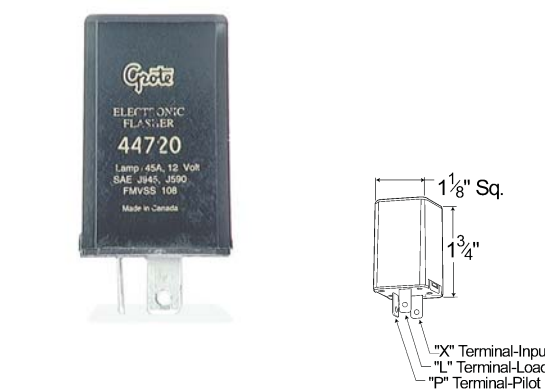

Flashers and Turn Signal Switches

Clignotants et Commutateurs Palancas Direccionales / Destelladores

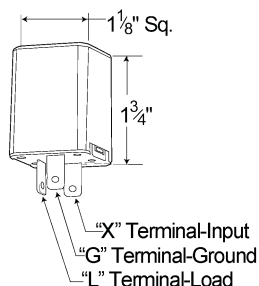

NORTH AMERICAN (JSO) PINOUT

Heavy-duty contacts • 44750 only, lamp outage at one lamp • Flash rate electronically timed • Fits most Dodge*, Ford*, Honda*, Mitsubishi*, Nissan* and Subaru* vehicles (see application guide) • Steady flash rate for all incandescent and LED leads

3 TERMINAL:

44892 Flasher

FMVSS: J945, J590
Volts / Amps: 12V / 1A - 20A; Lamp Load: 1-10 Lamps
Accessory: Bracket 43770

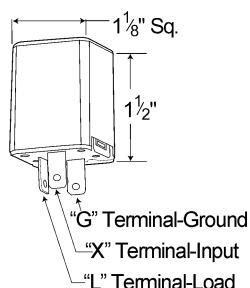

FLASHER EUROPEAN (ISO) PINOUT

Heavy duty contacts • Flash rate electronically timed • Fits most Toyota*, Chrysler* and pre '92 Chevrolet* ST Trucks (see application guide) • Steady flash rate for all incandescent and LED leads

3 TERMINAL:

44893 Flasher

FMVSS: J945, J590
Volts / Amps: 44893 - 12V / 1A - 20A; Lamp Load: 1-10 Lamps
Accessory: Bracket 43770

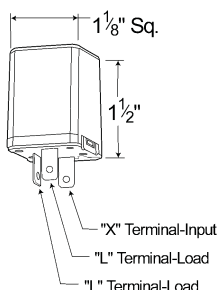

6-LAMP HEAVY-DUTY ALTERNATING ELECTRONIC FLASHER

11 to 15 volts DC • Less than 4 millivolts per amp voltage drop

3 TERMINAL:

44730 Flasher

FMVSS: J1054
Volts / Amps: 12V / 25A; Lamp Load: 1-10 lamps
Accessory: Bracket 43770



NON-LATCHING HEADLAMP DIMMER RELAY

Used for converting from floor-mounted dimmer switch to turn signal switch with lift-to-dim feature • Heavy-duty contact design provides years of trouble-free operation

44460 Relay

Volts / Amps: 12V / 20A - 30A capacity

24-TO 12-VOLT CONVERTER

Allows use of 12-Volt lighting / accessories on 24-Volt vehicles
 • Rugged die-cast housing • Solid state, fully potted electronics

44070 Converter

Material: Aluminum
 Finish: Bright
 Volts / Amps: 18V - 32V input, 13.8V output / 3A max



SOLID-STATE ELECTRONIC FLASHER

Designed for use with LED lighting • Provides steady flash rate over any load up to 12 Amps • Fully-potted, solid-state electronics • Self-resetting feature provides internal protection against short circuits

44010 3-Wire
44030 Alternating Flasher

Material: Aluminum
 FMVSS: Exceeds J590, J045
 Finish: Black
 Volts / Amps: 12V - 24V / 12A max

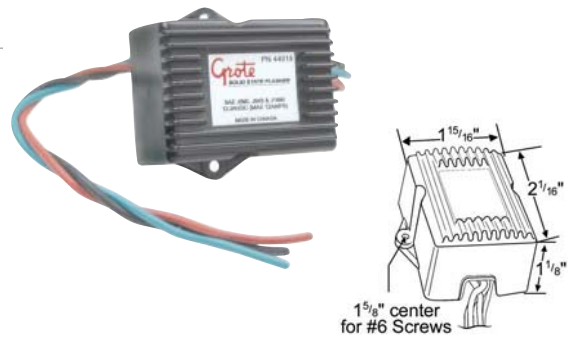

SCHOOL BUS FLASHER

• Standard OEM school bus flasher • Rugged anodized aluminum case with sealed electronics • 3 amps continuous • Industry-standards FastOn wiring terminals and pin assignments • Ultra-compact size occupies less space than conventional flashers • Highly efficient power-switching design very low heat loss

44900 Flasher new

Volts / Amps: 12V / 16A max

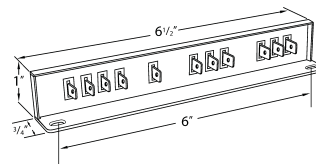

Flashers and Turn Signal Switches

Clignotants et Commutateurs Palancas Direccionales / Destelladores

Flasher Application Guide

Variable-load flashers may not have lamp outage indicators and may continue to flash at a normal rate even though one or more bulbs have failed. Inspect your lighting system frequently and replace any burned-out bulbs immediately. These flashers are designed for heavy-duty or trailer load applications.

Acura*

Year	Vehicle / Model	Exceptions	Part
1991-1986	Legend		44810
1997-1986	All others	CL, NSX, RL	44892

AMC*

Year	Vehicle / Model	Exceptions	Part
1988-1975	All		44810

Audi*

Year	Vehicle / Model	Exceptions	Part
1991-1970	All	1986 5000S / CS and CS Turbo Quattro and 1997 A4	44893

BMW*

Year	Vehicle / Model	Exceptions	Part
1974-1976	All		44820

Buick*

Year	Vehicle / Model	Exceptions	Part
1996-1992	Century		44810
1990-1985	Electra		44810
2005-2000	LeSabre		44140
1997	LeSabre		44810
2007-2004	Ranier		44140
2007-2002	Rendezvous		44140
1997	Riviera		44810

Cadillac*

Year	Vehicle / Model	Exceptions	Part
1993-1970	All	Allante, 1993 El Dorado and older	44810
1997-1994	All	others below	44892
1999-1989	Seville and STS	1990 Seville	44892
1997-1994	Catera		44810
1997-1994	Fleetwood		44810
2006-2003	Escalade		44140
1996-1970	All	1996 Skylark	44810

Chevrolet / GMC*

Year	Vehicle / Model	Exceptions	Part
Pre- 1997	2-Terminal Flasher	others if noted below	44810
Pre- 1997	3-Terminal Flasher	others if noted below; LUV, 1985-1988 Nova, 1980-1984 El Camino, 1982 Suburban	44893
Pre- 1993	3-Terminal Flasher, Commercial Trucks Only		44540
2006-2003	Avalanche		44140
1988-1987	Spectrum		44892
1988-1987	Sprint		44892
1993-1992	Vans with tow package		44530
2002-1996	Yukon		44120
2001-1998	Blazer		44120
2002-2000	Express		44120
2007-2003	Express		44160
2002-1998	S-Series Pickup		44120
2002-2000	Savanna		44120
2007-2003	Silverado		44140
2002-1999	Silverado		44120
2006-2004	Suburban		44140
2002-1996	Suburban		44120
2006-2003	SSR		44140
2002-2000	Tahoe		44120
2005-2003	Tahoe		44160
2008-2002	Trailblazer		44160

Chrysler*

Year	Vehicle / Model	Exceptions	Part
	2-Terminal Flasher		44810
	3-Terminal Flasher		44893
	5-Terminal Flasher		44090

Daihatsu*

Year	Vehicle / Model	Exceptions	Part
1992-1984	All	Rocky	44892

Dodge*

Year	Vehicle / Model	Exceptions	Part
	2-Terminal Flasher	others noted below	44810
	3-Terminal Flasher	others noted below	44893
1995-1970	All Cars	Monaco, Raider, 1985 Ram Van Wagon and Pickup	44810
1996-1986	Colt		44892
1993-1983	Ram 50		44892
1996-1986	Stealth		44892

Eagle*

Year	Vehicle / Model	Exceptions	Part
1989-1988	Medallion		44820
1996-1994	Summit		44892
1996-1992	Summit Wagon		44892
1993-1990	Talon		44892
1995-1993	Vision		44893

Fiat*

Year	Vehicle / Model	Exceptions	Part
1983-1970	All		44820

Ford*

Year	Vehicle / Model	Exceptions	Part
	2-Terminal Flasher		44810
Pre- 1993	3-Terminal Flasher, Commercial Trucks Only		44540
	3-Terminal Flasher		44892
	5-Terminal Flasher		44090
1997-1972	E-Series Truck		44530
1964	Thunderbird		44820

GMC*

Year	Vehicle / Model	Exceptions	Part
2005-2004	Canyon		44140
2008-2002	Envoy		44140
2000-1998	Envoy		44120
2002-1996	Full Size C / K Pickup		44120
2001-1998	Jimmy		44140
2006-2003	Yukon		44140
2007-2003	Savannah		44160
2007-2003	Sierra-Series		44140
1991-1978	All		44810

Geo*

Year	Vehicle / Model	Exceptions	Part
1996-1989	Metro		44892
1997-1989	Prizm		44893
1989	Spectrum		44892
1993-1990	Storm		44892
1995-1989	Tracker		44892

Honda*

Year	Vehicle / Model	Exceptions	Part
	2-Terminal Flasher		44810
	3-Terminal Flasher		44892
1981-1976	Accord		44810

Hyundai*

Year	Vehicle / Model	Exceptions	Part
1988-1986	All		44893
1995-1989	All		44892

Hummer*

Year	Vehicle / Model	Exceptions	Part
2007-2003	H2		44140

Infiniti*

Year	Vehicle / Model	Exceptions	Part
1996-1990	All	1996 I30	44892

Flashers and Turn Signal Switches

Clignotants et Commutateurs Palancas Direccionales / Destelladores

Flasher Application Guide

International

Year	Vehicle / Model	Exceptions	Part
1980-1974	All		44810

Isuzu

Year	Vehicle / Model	Exceptions	Part
2006-2003	Ascender		44140
2004-1987	All		44892

Jaguar

Year	Vehicle / Model	Exceptions	Part
1996-1978	XJ6, XJS, XJ12		44820
1989-1986	XJ6, XJS		44892
1996-1990	XJS		44893

Jeep

Year	Vehicle / Model	Exceptions	Part
1997-1994	Grand Cherokee		44090
1996-1978	All	1993 Grand Wagoneer, 1996 Grand Cherokee, 1986 CJ and Scramble	44810

Lexus

Year	Vehicle / Model	Exceptions	Part
1996-1990	All		44893

Lincoln

Year	Vehicle / Model	Exceptions	Part
	2-Terminal Flasher		44810
	3-Terminal Flasher		44892
	5-Terminal Flasher		44090

Mazda

Year	Vehicle / Model	Exceptions	Part
1984-1971	2-Pin		44180

Mercury

Year	Vehicle / Model	Exceptions	Part
	2-Terminal Flasher		44810
	3-Terminal Flasher		44892
	5-Terminal Flasher		44090

Mitsubishi

Year	Vehicle / Model	Exceptions	Part
	2-Terminal Flasher		44810
	3-Terminal Flasher	others noted below	44892
1989-1987	Precis		44893

Nissan

Year	Vehicle / Model	Exceptions	Part
	2-Terminal Flasher		44810
	3-Terminal Flasher		44892

Oldsmobile

Year	Vehicle / Model	Exceptions	Part
	2-Terminal Flasher		44810
	3-Terminal Flasher		44893
	4-Terminal Flasher		44120
	5-Terminal		44090
2004-2002	Bravada		44140

Peugeot

Year	Vehicle / Model	Exceptions	Part
1991-1982	All		44820

Plymouth

Year	Vehicle / Model	Exceptions	Part
1991-1975	All		44810

Pontiac

Year	Vehicle / Model	Exceptions	Part
	2-Terminal Flasher		44810
	3-Terminal Flasher		44893
	5-Terminal		44090
2005-2001	Aztec		44140
1991-1989	LeMans		44892

Porsche

Year	Vehicle / Model	Exceptions	Part
	2-Terminal Flasher	others noted below	44810
	3-Terminal Flasher	others noted below	44893
1986-1978	924 (Hazard Flasher)		44820
1982-1978	928 (Hazard Flasher)		44820
1986-1978	944 (Hazard Flasher)		44820

Renault

Year	Vehicle / Model	Exceptions	Part
1986-1983	2 Pin		44810
1986-1983	3 Pin		44820
1980-1978	All (Hazard Flasher)		44820
1985-1982	Alliance		44810
1985-1984	Encore		44810
1985-1982	Fuego		44820

SAAB

Year	Vehicle / Model	Exceptions	Part
1996-1982	All	others noted below	44893
2008-2005	9-7X		44140
1980-1978	99 and 99GL		44892
1980-1978	900		44893
1981	900		44892
1997	9000CS Hatchback		44893
1999	Sonett		44820
1975-1974	All		44820

Saturn

Year	Vehicle / Model	Exceptions	Part
	All	S-Series	44893

Sterling

Year	Vehicle / Model	Exceptions	Part
	All		44893

Subaru

Year	Vehicle / Model	Exceptions	Part
	2-Terminal Flasher		44810
	3-Terminal Flasher		44892

Suzuki

Year	Vehicle / Model	Exceptions	Part
	All		44892

Toyota

Year	Vehicle / Model	Exceptions	Part
	All	others noted below	44893
1980-1978	Cresida		44892
1980-1978	Land Cruiser		44810
1997	Previa		44892

Triumph

Year	Vehicle / Model	Exceptions	Part
1982-1970	All (Turn Flasher)		44810
1982-1970	All (Hazard Flasher)	44820	

Volkswagon

Year	Vehicle / Model	Exceptions	Part
	All		44893

Volvo

Year	Vehicle / Model	Exceptions	Part
	All		44893

Yugo

Year	Vehicle / Model	Exceptions	Part
	All		44820

Flashers and Turn Signal Switches

Clignotants et Commutateurs Palancas Direccionales / Destelladores



RUBBER-GRIP TURN SIGNAL SWITCH WITH 2-SPEED WIPER CONTROL

New OEM-style 1" diameter rubber grip • Provides hi / lo wiper control and push-button wash control • 18-bulb capacity makes switch ideal for triple-trailer applications • OEM mounting style fits TRW® columns without self-cancel

48562 OEM Style **new**



RUBBER GRIP TURN SIGNAL SWITCH WITH 2 SPEED WIPER CONTROL

New OEM-style 1" diameter rubber grip • Provides hi / lo wiper control and push button wash control • 18-bulb capacity makes switch ideal for triple trailer applications • Mounting hardware kit includes tapped inserts with screws for mounting to existing brackets and a worm gear clamp with range of 1" to 2.5" circular columns

48563 Universal-Style **new**



TURN SIGNAL SWITCH WITH FLASH-TO-PASS AND MARKER FLASH

• Provides 2 M-4 threaded holes for column mounting • 18-bulb capacity makes switch ideal for triple trailer configurations • Replaces Grote® 01-4840-70 / 71 • Replaces Mack® 1MR574

48402 Flash-to-pass **new**



UNIVERSAL 7-WIRE / 4-WIRE TURN SIGNAL SWITCH KIT

Replaces Truck-Lite® and Signal-Stat® 900-902 920, and 2900-3 • Includes switch, mounting hardware and 24" blunt-cut, harness • 4- or 7-wire system • Adapts to applications without brake override functions • For applications with floor-mounted dimmer switch • 18 bulb capacity makes switch ideal for triple trailer configurations • Compatible with 24-Volt systems if indicator bulb is replaced with Grote's® 24-Volt bulb (1450) • Mounting hardware kit includes threaded inserts with screws for mounting to existing brackets and a worm gear clamp with a range of 1.6" to 2.5" for mounting to circular column tubes

48072 Turn Signal Switch Kit

FMVSS: Q
 Finish: Black
 Bulb: (Indicator) 53, 1 CP
 Volts / Amps: 12V / .12A
 Accessory: Switch 48272; Harness: 69680

UNIVERSAL TURN SIGNAL SWITCH

Universal replacement without hi-low beam function • 18-bulb capacity makes switch ideal for triple-trailer configurations • Mounting hardware kit includes tapped inserts with screws for mounting to existing brackets and a worm gear clamp with a range of 1" to 2.5" for mounting to circular column trucks • Integral RH and LH turn / hazard indicator lights • Adapts to applications without brake override functions • Compatible with 24 volt systems if indicator bulb is replaced with Grote's® 24 volt bulb (1450)



48272 Turn Signal Switch

FMVSS: Q
 Finish: Black
 Bulb: (Indicator) 53, 1 CP Volts / Amps: 12V / .12A
 Accessory: Harness: 69680

UNIVERSAL TURN SIGNAL SWITCH WITH LIFT-TO-DIM

18 bulb capacity makes switch ideal for triple trailer configurations • Mounting hardware kit includes tapped inserts with screws for mounting to existing brackets and a worm gear clamp with a range of 1." to 2.5" for mounting to circular column trucks • Adapts to applications without brake override functions



48282 Universal Turn Signal Switch

FMVSS: Q
 Finish: Black
 Accessory: Harness: 69690

UNIVERSAL REPLACEMENT HARNESS

Fits 48272 switch • Overall length of 24" is sufficient for most applications • Flexible black PVC loom adds protection without adding rigidity • Compatible with 4- to 7-wire systems • Includes circuitry for switches with integral RH and LH turn / hazard indicator light



69680 Universal Harness

UNIVERSAL PLUG-IN 12-WIRE HARNESS FOR SWITCHES WITH CRUISE OR WIPER CONTROL

Overall length of 24" is sufficient for most applications • Flexible PVC loom adds protection without adding rigidity • Provides 12 connections for any Grote® switch requiring up to 12 circuits • Provides circuits for cruise control, wiper control, flash-to-pass or marker flash • Use with switches 48442, 48512, 48602, 48562 or 48563



69681 Harness new

UNIVERSAL PLUG-IN WIRING HARNESS WITH LIFT-TO-DIM

Fits 48282 switch • Includes 44460 non-latching relay • Includes connector for headlamp relay • Compatible with 4- to 7-wire system • Overall length of 24" is sufficient for most applications • Flexible black PVC loom adds protection without adding rigidity

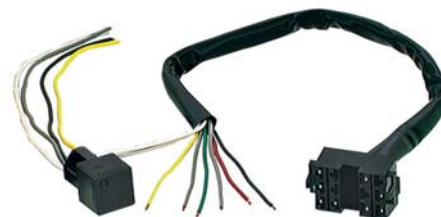

69690 Universal Harness

Flashers and Turn Signal Switches

Clignotants et Commutateurs Palancas Direccionales / Destelladores



KENWORTH® OEM REPLACEMENT SWITCH WITH HARNESS

Replaces Freightliner® GRO 01-4811-87, Grote® 01-4811-87, and Paccar® K301-295-3 • Black worm gear mounting clamp included • OEM-style, 20" plug-in wiring harness included • 18-bulb capacity makes switch ideal for triple-trailer configurations

48532 Turn Signal Switch Kit

FMVSS: Q
Finish: Black



FREIGHTLINER® OEM REPLACEMENT SWITCH

Replaces Freightliner® GRO 01-4811-77 • 18-bulb capacity makes switch ideal for triple-trailer configurations • Plugs into OE harness on truck • Mounts with a separate worm gear clamp

48522 Turn Signal Switch Kit

FMVSS: Q
Finish: Black



OEM-STYLE TURN SIGNAL SWITCH

Replaces Freightliner® GRO 01-4811-82 • Includes 15" plug-in harness with fuse holder • 18-bulb capacity makes switch ideal for triple-trailer configurations • Mounts with separate worm gear clamp

48542 Turn Signal Switch

FMVSS: Q
Finish: Black



OEM-STYLE TURN SIGNAL SWITCH

Replaces Freightliner® GRO 01-4813-80 and GRO 01-4813-81 • 18-bulb capacity makes switch ideal for triple-trailer configurations • Mounting bracket included

48552 Turn Signal Switch

FMVSS: Q
Finish: Black

OEM-STYLE NON-DIMMERTURN SIGNAL SWITCH

Replaces PACCAR* 01-4806-92, TRW* 480811 without harness • 18-bulb capacity makes switch ideal for triple-trailer configurations • Adapts to applications without brake override function • Provides hazard / warning, left / right turn, lift-to-dim functions

48062 Turn Signal Switch

FMVSS: Q
Finish: Black



OEM-STYLE TURN SIGNAL SWITCH FOR PACCAR*

Replaces PACCAR* 01-4813-91, TRW* 480819 without harness • 18-bulb capacity makes switch ideal for triple-trailer configurations • Adapts to applications without brake override function • Provides hazard / warning, right / left turn, lift-to-dim functions

48132 Turn Signal Switch

FMVSS: Q
Finish: Black



OEM-STYLE TURN SIGNAL SWITCH FOR INTERNATIONAL*

Replaces International* 354493C92 without harness • 18-bulb capacity makes switch ideal for triple-trailer configurations • Adapts to applications without brake override function • Provides hazard / warning, left / right turn, lift-to-dim functions

48283 Turn Signal Switch

FMVSS: Q
Finish: Black



Flashers and Turn Signal Switches

Clignotants et Commutateurs Palancas Direccionales / Destelladores



UNIVERSAL OEM-STYLE RUBBER-GRIP TURN SIGNAL SWITCH

New style 1" diameter rubber grip • 18-bulb capacity makes switch ideal for triple-trailer configurations • Adapts to applications without brake override function • Provides hazard / warning, left / right turn, lift-to-dim functions • Mounting hardware kit includes tapped inserts with screws for mounting to existing brackets and a worm gear clamp with a range of 1" to 2.5" for mounting to round columns

48284 Turn Signal Switch

FMVSS: Q
Finish: Black



OEM-STYLE MARKER / FLASH TURN SIGNAL SWITCH FOR PACCAR*

Replaces PACCAR* 01-4843-75, TRW* 480829 without harness • Chrome-plated end push button for flashing marker lamps • 18-bulb capacity makes switch ideal for triple-trailer configurations • Adapts to applications without brake override function

48432 Turn Signal Switch

FMVSS: Q
Finish: Black



OEM-STYLE MARKER / FLASH TURN SIGNAL SWITCH FOR INTERNATIONAL*

Replaces International* 2004506C91 without harness • Chrome-plated end push-button for flashing marker lamps • 18-bulb capacity makes switch ideal for triple-trailer configurations • Adapts to applications without brake override function

48433 Turn Signal Switch

FMVSS: Q
Finish: Black



OEM-STYLE MARKER / FLASH AND WIPER TURN SIGNAL SWITCH FOR INTERNATIONAL*

Replaces International* 2004505C91 without harness • 18-bulb capacity makes switch ideal for triple-trailer configurations • Adapts to applications without brake override function • Provides hazard / warning, left / right turn, lift-to-dim functions • Mounting hardware kit includes tapped inserts with screws for mounting to existing brackets and a worm gear clamp with a range of 1" to 2.5" for mounting to round columns • Chrome-plated end push-button for flashing marker lamps • Slide switch for 2-speed wiper control

48442 Turn Signal Switch

FMVSS: Q
Finish: Black

WIPER AND OEM-STYLE WASH, TURN SIGNAL SWITCH

Chrome-plated end push-button for wash • Slide switch for wiper hi / lo control • 18-bulb capacity makes switch ideal for triple-trailer configurations • Adapts to applications without brake override function

48512 Turn Signal Switch

FMVSS: Q
Finish: Black



OEM-STYLE RUBBER GRIP TURN SIGNAL SWITCH

Replaces TRW* 480788 / 480787 without harness • 18-bulb capacity • Adapts to applications without brake override function • New style 1" diameter rubber grip • Includes Grote® patented turn self-cancel mechanism

48302 Turn Signal Switch

FMVSS: Q
Finish: Black



OEM-STYLE RUBBER-GRIP TURN SIGNAL SWITCH WITH CRUISE CONTROL

New style 1" diameter grip • Provides on / off, set, resume and accelerate cruise-control switching functions • 18-bulb capacity makes switch ideal for triple-trailer configurations • Adapts to applications without brake override function • Replaces TRW* 480789, Freightliner* 06-54461-000 without harness • Includes Grote® patented turn self-cancel mechanism

48602 Turn Signal Switch

FMVSS: Q
Finish: Black



Mirrors

Rétroviseurs Espejos

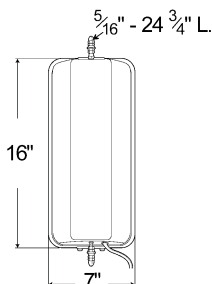

7" X 16" REMOTE-CONTROL HEATED MIRROR ASSEMBLY

40% lighter than competitive models • Stainless-steel housing resists corrosion • Complete wiring, control switch and simple installation instructions included

- 28461** Stainless-Steel, Heated, Motorized
28463 Stainless-Steel, Heated, Non-motorized

Material: Stainless-Steel
 Reflective: 94 sq. in.
 Finish: Stainless
 Volts / Amps: 12V / 3.1A
 Accessory: C-Loop: 22233 / 22232
 Bracket: 22013, 22063, 22061

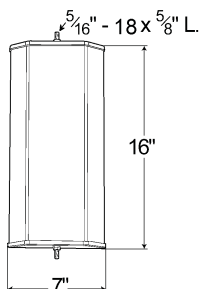

ICE AND FROST-FREE HEATED WEST COAST MIRROR

OEM-style, 7"x16" mirror head • Internal heating element • Polished plate glass, silvered mirror

- 16053** Stainless-Steel

Material: Stainless-Steel
 Reflective: 101 sq. in.
 FMVSS: 111 Vehicles with GVWR Greater than 10,000 lbs.
 Finish: Stainless
 Volts / Amps: 12V / 3.1A
 Accessory: C-Loop: 22233 / 22232
 Bracket: 22013, 22063, 22061

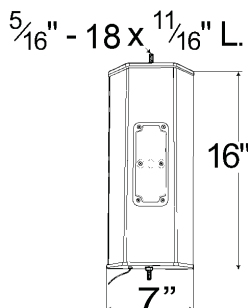

WEST COAST MIRROR WITH CLEARANCE LIGHT

Double-strength silvered mirror • Blunt cut pigtail

6" X 16" MIRROR:

- 16172** Black w/ Light and Heated
16063 Stainless-Steel w/ Light
16173 Stainless-Steel w/ Light and Heated

7" X 16" MIRROR:

- 16223** Stainless-Steel w/ Light and Heated

Material: Stainless-Steel / Steel
 Reflective: 87 sq. in. (except 16223: 101 sq. in.)
 FMVSS: 111 Vehicles with GVWR Greater than 10,000 lbs.
 Finish: Black / Stainless
 Bulb: (2) 67, 4 CP
 Volts / Amps: C / M Lamp - 12V / 1.18A
 Volts / Amps: Heater - 12V / 3.1A
 Accessory: C-Loop: 22233 / 22232
 Gasket: 51910701
 Bracket: 22013, 22063, 22061
 Lens: Yellow 90393

OEM-STYLE SPLIT-FOCUS BOX-TYPE MIRROR

Built-in adjustable convex blind spot mirror • Provides close-in side view
• Double-strength silvered mirror

- 16041** White Enamel
- 16043** Stainless-Steel

Material: Stainless-Steel / Steel
 Reflective: 57 sq. in. flat area; 20 sq. in. convex
 FMVSS: 111 Vehicles with GVWR Greater than 10,000 lbs.
 Finish: White / Stainless
 Accessory: C-Loop: 22233 / 22232
 Bracket: 22013, 22063, 22061

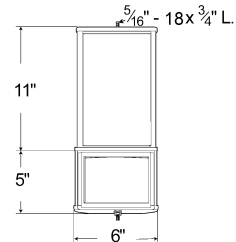

OEM-STYLE BOX MIRROR

Double-strength silvered mirror • Weather-sealed in vinyl • Painted mirrors feature rugged powder coat finish

6" X 16" MIRROR:

- 16021** White
- 16023** Stainless-Steel

7" X 16" MIRROR:

- 16123** Stainless-Steel

Material: Stainless-Steel / Steel
 Reflective: 87 sq. in.
 FMVSS: 111 Vehicles with GVWR Greater than 10,000 lbs.
 Finish: White / Stainless
 Accessory: C-Loop: 22233 / 22232
 Bracket: 22013, 22063, 22061

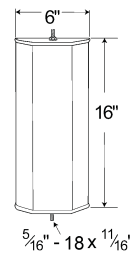

ECONOMY WEST COAST MIRROR

Aluminum back mirror • 5/16" plated rod • Silvered mirror

- 16244** Aluminum

Material: Aluminum
 Reflective: 87 sq. in.
 FMVSS: 111 Vehicles with GVWR Greater than 10,000 lbs.
 Finish: Aluminum
 Accessory: C-Loop: 22233 / 22232
 Bracket: 22013, 22061, 22063

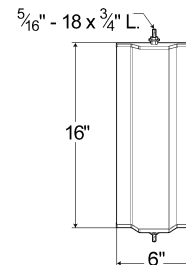

ECONOMY WEST COAST MIRROR

Composite construction • Rigid warp-proof design features an aero wing, honey-comb-type structure

- 16202** Black

Material: DURAMOLD®
 Reflective: 95 sq. in.
 FMVSS: 111 Vehicles with GVWR Greater than 10,000 lbs.
 Finish: Black
 Accessory: C-Loop: 22233 / 22232
 Bracket: 22013, 22061, 22063

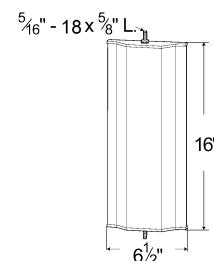

Mirrors

Rétroviseurs Espejos

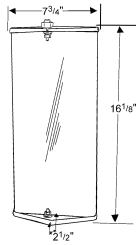

NAVISTAR® ALUMINUM WEST COAST REPLACEMENT MIRROR

Anodized, polished aluminum finish (matches OE finish) • Glass-filled nylon end caps for durability and strength • Includes mounting hardware
• Heated mirrors feature molded Navistar® plug

16284 Aluminum

HEATED MIRROR:

16294 Aluminum, Passenger Side

16304 Aluminum, Driver Side

Material: Aluminum / Nylon
Reflective: 101 sq. in.
FMVSS: 111 Vehicles with GVWR Greater than 10,000 lbs.
Finish: Aluminum
Volts / Amps: 16294, 16304 - 12V / 1.25A

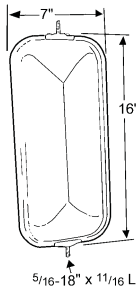

OEM-STYLE PEAK-BACK WEST COAST MIRROR

Distinctive pyramid-style back interchanges functionally and aesthetically with competitive units • Shock-resistant mirror glass mounting with a rugged outer gasket • Robust one-piece mirror back design • Heated mirror features 5' jacketed power cable • 5/16"-18 mounting stud

16273 Stainless-Steel

16142 Black

HEATED MIRROR:

16153 Stainless-Steel

Material: Steel / Stainless-Steel
Reflective: 101 sq. in.
FMVSS: 111 Vehicles with GVWR Greater than 10,000 lbs.
Finish: Black / Stainless
Volts / Amps: 16153 - 12V / 1.25A
Accessory: C-Loop: 22233, 22232
Bracket: 22013, 22063, 22061



OEM-STYLE BUBBLE-BACK WEST COAST MIRROR

Double-strength silvered mirror • 7" x 16" mirror • Rugged powder-coat finish

16101 White

16102 Black

26021-5 White, w / Arm Assembly, Retail Pack

Material: Steel
Reflective: 93 sq. in.
FMVSS: 111 Vehicles with GVWR Greater than 10,000 lbs.
Finish: White / Black
Accessory: C-Loop: 22233 / 22232
Bracket: 22013, 22061, 22063

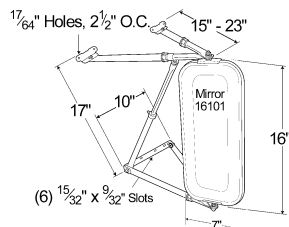

OEM-STYLE FLAT RIBBED-BACK WEST COAST MIRROR

Double-strength silvered mirror • 7" x 16" mirror • Painted mirrors feature rugged powder coat finish

- 16091** White
- 16092** Black
- 16093** Stainless-Steel

MIRROR AND WEST COAST ASSEMBLY

- 26001-5** White, w / Arm Assembly, Retail Pack
- 26012-5** Black, w / Arm Assembly, Retail Pack

Material: Stainless-Steel / Steel
 Reflective: 93 sq. in.
 FMVSS: 111 Vehicles with GVWR Greater than 10,000 lbs.
 Finish: White / Black / Stainless
 Accessory: C-Loop: 22233 / 22232
 Bracket: 22013, 22063, 22061

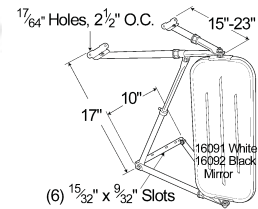

WEST COAST MIRROR ASSEMBLIES

Complete kit includes mirror arms, mounting, hardware and instructions
 • Rigid mounting for West Coast style mirrors • Accommodates additional stack-on spot mirrors

- 22013** Stainless-Steel

Material: Steel / Stainless-Steel
 Finish: Stainless

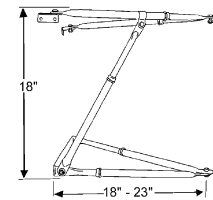

CUSTOM BRACKET ASSEMBLY

Bracket assembly for personal custom design • Braces included
 • Fully adjustable from 18" to 23"

- 22061** White, Powder-Coated
- 22063** Chrome-Plated

Material: Steel
 Finish: White / Chrome

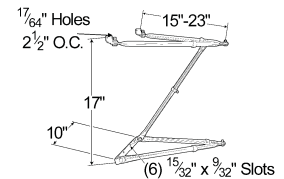

C-LOOP BRACKETS

Can be used in conjunction with most West Coast bracket assemblies
 • Allows for adjustable, "break-away" mounting of any 7" x 16" or 6" x 16" West Coast mirror • Accommodates additional stack-on spot mirrors

- 22233** Stainless-Steel
- 22232** Black

Material: Steel / Stainless-Steel
 Finish: Black / Stainless

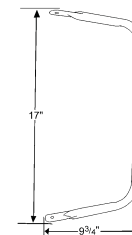

WEST COAST REPLACEMENT HEATING ELEMENT

Defroster element fits West Coast style mirrors • Water resistant
 • 40-Watts • Fits 6" x 16" or 7" x 16" West Coast Mirrors

- 29060** Element

Material: Adhesive Heated Board
 Volts / Amps: 12V / 3.1A

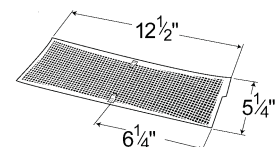

Mirrors

Rétroviseurs Espejos

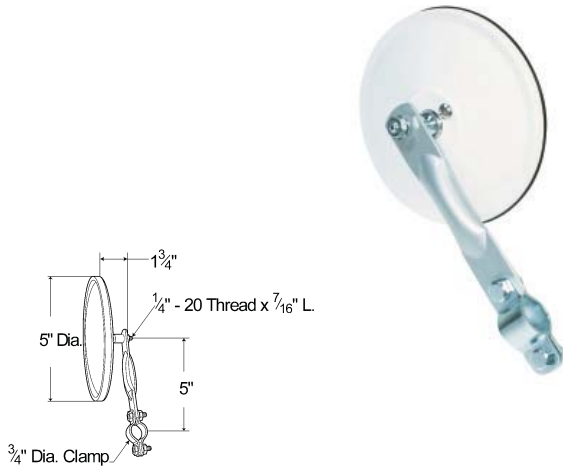

5" ROUND CLAMP-ON STACK-AND-SPOT MIRROR ASSEMBLY

Provides wider vision • Includes arm and clamp to attach securely to mirror arm • Single-strength silvered mirror

5" CONVEX:

- 28031** White, Powder-Coated, w / Arm Assembly
- 28032** Black, Powder-Coated, w / Arm Assembly
- 28033** Stainless-Steel, w / Arm Assembly
- 28033-5** Stainless-Steel, w / Arm Assembly, Retail Pack

5" FLAT GLASS:

- 28162** Black, Powder-Coated, w / Arm Assembly
- 28152** Black w / "L" Bracket

Material: Stainless-Steel / Steel
 Reflective: 5" - 20 sq. in.
 Finish: Stainless / White / Black
 Accessory: Extension Arm: 10073



6" CONVEX CENTER-MOUNT SPOT MIRROR

Features Stainless-Steel construction and adjustable ball swivel • Available with or without "L" bracket

MIRROR HEAD ONLY

- 12053** Stainless-Steel, Mirror Head Only
- 12052** Black, Mirror Head Only

MIRROR HEAD AND "L" BRACKET

- 28663** Stainless-Steel, w / "L" Bracket

MIRROR HEAD AND ARM ASSEMBLY

- 28041** White, Powder-Coated, w / Arm Assembly
- 28042** Black, Powder-Coated, w / Arm Assembly
- 28043** Stainless-Steel, w / Arm Assembly

Material: Stainless-Steel
 Reflective: 28 sq. in.
 Finish: Stainless / Black / White
 Accessory: Arm Assembly: 10173 (with "L" Bracket)
 Bracket: 10073 (Arm Assembly Only), 11303("L" Bracket Only),

8" ROUND CONVEX MIRROR WITH CENTER-MOUNT BALL-STUD

Three-screw stud tightens firmly • 1/4" UNC female ball-stud • Painted mirrors feature rugged powder-coated finish • 12283 heated mirror includes 60" two-conductor jacketed blunt-cut cable and adhesive heater board

- 12182** Black
- 12183** Stainless-Steel
- 12293** Stainless-Steel with Attached "L" Bracket

PLASTIC HOUSING:

- 12983** Chrome

HEATED MIRROR:

- 12283** Stainless-Steel

Material: Stainless-Steel / Steel / DURAMOLD®
 Reflective: 46.7 sq. in.
 Finish: Stainless / Black / Chrome
 Volts / Amps: 12V / 1.18A
 Bracket: 11133

8" ROUND CONVEX MIRROR WITH OFFSET BALL-STUD

Easy mounting in tight installations • Ball-stud offset 2" from center
 • 60" two-conductor, jacketed, blunt-cut cable

- 12172** Black, Powder-Coated
- 12173** Stainless-Steel

HEATED MIRROR:

- 12813** Stainless-Steel

Material: Stainless-Steel / Steel
 Reflective: 46 sq. in.
 Finish: Stainless / Black
 Volts / Amps: 12813 - 12V / 1.18A

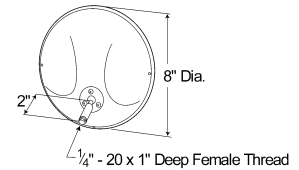

8 1/2" CONVEX MIRROR WITH CENTER-MOUNT BALL-STUD

Bright Stainless-Steel finish • Adjustable ball-stud mounting
 • Single-strength silvered mirror • Includes "L" Bracket

- 16033** Stainless-Steel
- 16032** Black

Material: Stainless-Steel / Steel
 Reflective: 56 sq. in.
 Finish: Stainless / Black / Chrome
 Bracket: 11303

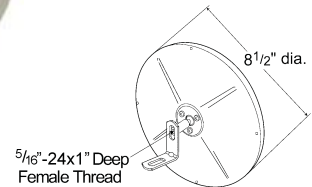

8" ELLIPTICAL MIRROR

Eliminates blind spots • Optimum crossover viewing
 • 4 1/4" radius x 7 11/16" dia.

- 12272-5** Black, Mirror Head Only, Retail Pack

Material: Steel
 Reflective: 45 sq. in.
 Finish: Black / White

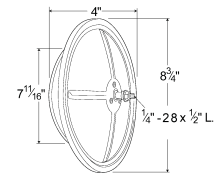

CONVEX MIRROR WITH CENTER MOUNT

Popular for highway service vehicles • Reinforced internal retainers
 • Large steel ball-stud for precise positioning • Replacement for 10 1/2" crossover mirrors

10 1/2" CONVEX MIRROR:

- 12010** Stainless-Steel

12" CONVEX MIRROR:

- 12020** Gray, 3/8 - 24 11/16 Deep-Thread Ball-Stud

Material: Stainless-Steel / Steel
 Reflective: 10 1/2": 95 sq. in. / 12": 135 sq. in.
 Finish: Stainless / Gray

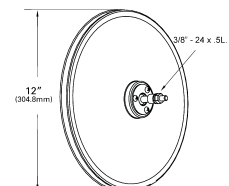
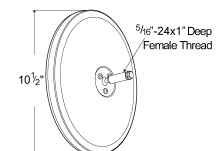

Mirrors

Rétroviseurs Espejos

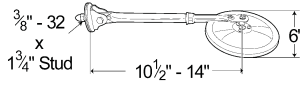

ADJUSTABLE MIRROR ASSEMBLY

Arm adjustable from 10" to 13" • Swivel bracket enables precise adjustment • Chrome arm and brackets

28193 6" Mirror (12053) and Adjustable Arm Assembly
10433 Arm and Swivel Bracket Only

Material: Stainless-Steel / Steel
 Reflective: 26 sq. in.
 Finish: Stainless

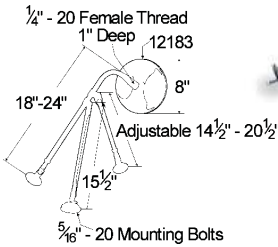
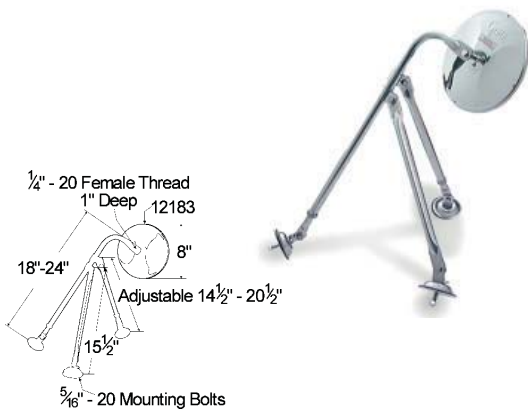

CONVENTIONAL FENDER-MOUNT MIRROR ASSEMBLY

8" Stainless-Steel convex mirror • Stainless-Steel brackets • Bell cup mounting for fiberglass fenders • Grote 8" convex mirror (12182 / 3) will fit bracketry

28443 Stainless-Steel Assembly Including Mirror (12183)
22193 Stainless-Steel, Bracket Only

Material: Stainless-Steel
 Reflective: 46 sq. in.
 Finish: Stainless

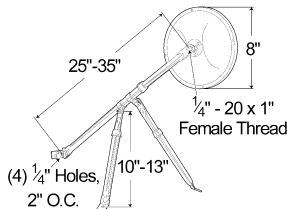
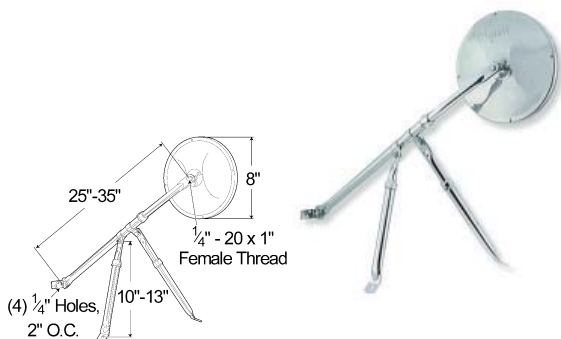

SCHOOL BUS EXTERIOR BLIND SPOT MIRROR ASSEMBLY

Meets state laws for blind spot visibility • Zinc-plated bracketry • 8" convex mirror

28063 Vertical-Mount Assembly, Stainless-Steel (12183)
11195 Bracket Only

Material: Stainless-Steel / Steel
 Reflective: 46 sq. in.
 Finish: Stainless

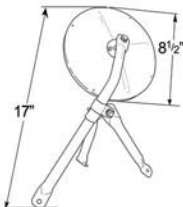

8 1/2" CONVEX CROSS-OVER MIRROR ASSEMBLIES

Ideal for improving safety on straight trucks and delivery trucks • 8 1/2" assemblies feature rugged tripod mount for front or rear • Features heavy-duty steel construction

28481 White, Mirror Assembly

Material: Steel
 Reflective: 56 sq. in.
 Finish: White

HOOD-MOUNTED MIRROR ASSEMBLIES

Bright Stainless-Steel finish • Assembly comes with both a curved and straight extension for improved vision and range of application • Kit includes backing plate, gasket, mounting hardware and instructions
 • 8 1/2" convex Stainless-Steel mirror head included

12153 Stainless-Steel

Material: Stainless-Steel
 Reflective: 56 sq. in.
 Finish: Stainless

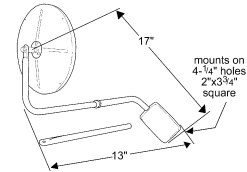

10 1/2" CONVEX CROSS-OVER MIRROR ASSEMBLIES

Ideal for improving safety on straight trucks and delivery trucks • Features heavy-duty steel construction • Features rigid 90° bracket

28491 White, Mirror Assembly
28493 Stainless-Steel, Mirror Assembly

Material: Stainless-Steel / Steel
 Reflective: 95 sq. in.
 Finish: Stainless / White

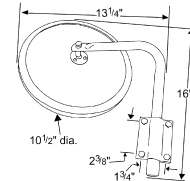

BUS FENDER BRACKETRY

Designed for, but not limited to, use on school bus fenders • Accepts any ball-stud mounted mirror • Adjustable mounting for exact positioning of mirror for optimum safety

22002 Black

Material: Steel
 Finish: Black

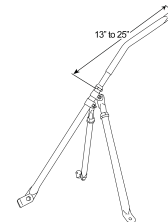

SPLIT MIRROR ASSEMBLY

Swing-away feature with detent • Fits right or left side • Top mirror is 6 1/2" x 10" flat glass • Bottom mirror is 6 1/2" x 6" convex

28451 White
28453 Stainless-Steel

REPLACEMENT 6 1/2" X 10" MIRRORS:

12301 White
12303 Stainless-Steel

REPLACEMENT 6 1/2" X 6" MIRRORS:

12331 White
12333 Stainless-Steel

Material: Stainless-Steel / Steel
 Reflective: 10": 56 sq. in. 6": 33 sq. in.
 Finish: Stainless / White

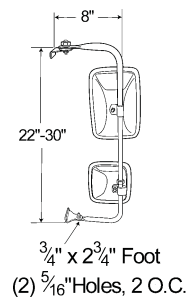

Mirrors

Rétroviseurs Espejos

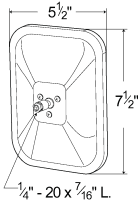

ROLLED-RIM MIRROR WITH BALL SWIVEL

1/4" - 20" x 7/16" ball swivel • Painted mirrors feature rugged powder-coat finish

- 12071** White
- 12072** Black
- 12073** Stainless-Steel
- 12073-5** Stainless-Steel, Retail Pack

Material: Stainless-Steel / Steel
 Reflective: 33 sq. in.
 Finish: Stainless / White / Black

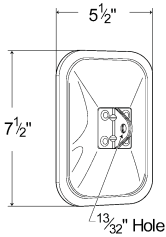

ROLLED-RIM MIRROR WITH CENTER MOUNT

5 1/2" x 7 1/2" rectangular mirror • Inner glass cushion • Center mount

- 12243-5** Stainless-Steel, Retail Pack

Material: Stainless-Steel
 Reflective: 33 sq. in.
 Finish: Stainless

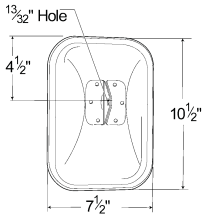

BELOW-EYE-LEVEL MIRROR

Offset mount • 7 1/2" x 10 1/2" mirror • Painted mirrors feature rugged powder-coat finish

- 12111-5** White, Retail Pack
- 12112-5** Black, Retail Pack
- 12113-5** Stainless-Steel, Retail Pack

Material: Stainless-Steel / Steel
 Reflective: 61 sq. in.
 Finish: Stainless / White / Black

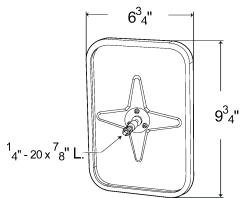

OUTER PROTECTIVE BUMPER TYPE MIRROR

Ball swivel • 7" x 10" rectangular mirror • Painted mirrors feature rugged powder-coat finish

- 12101** White
- 12102** Black

Material: Steel
 Reflective: 52 sq. in.
 Finish: White / Black

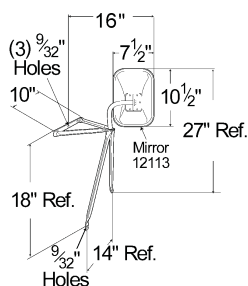

SUPER TRIPOD-MOUNT MIRROR ASSEMBLY

Stainless-Steel tripod brackets • Offset mounting • Flips to total field of vision • Jumbo 7 1/2" x 10 1/2" Stainless-Steel head

- 28323-5** Stainless-Steel, Retail Pack

Material: Stainless-Steel
 Reflective: 61 sq. in.
 Finish: Stainless
 Accessory: 90° Arm: 10623, Extension Arm: 10083

VERSATILE-TRIPOD MIRROR ASSEMBLY

For Chevrolet*, GMC*, Ford*, and other pickups • Universal mounting; 7 1/2" x 10 1/2" mirror head • Painted mirrors feature rugged powder coat finish

- 28091-5** White, Retail Pack
- 28093-5** Stainless-Steel, Retail Pack

Material: Stainless-Steel / Steel
 Reflective: 60 sq. in.
 Finish: Stainless / White
 Accessory: 90° Arm: 10623
 Extension Arm: 10083

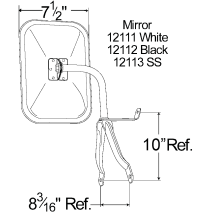

TRAILER HAUL FENDER-MOUNT MIRROR ASSEMBLY

Fits left or right side • Exclusive clip protrusions • Clamps coated to protect against marring finish

- 28083-5** Stainless-Steel, Chrome Arms, Retail Pack

Material: Stainless-Steel / Steel
 Reflective: 33 sq. in.
 Finish: Stainless

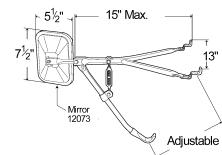

50" WIDE-VIEW MIRROR ASSEMBLY

OEM-styled mirror, fits right or left side • Anodized aluminum arm • Three-screw ball swivel • Fits full-size pickup trucks and vans

- 28293-5** Stainless-Steel, Retail Pack
- 12193-5** Stainless-Steel, Mirror Only, Retail Pack

Material: Stainless-Steel / Aluminum
 Reflective: 50 sq. in.
 Finish: Stainless

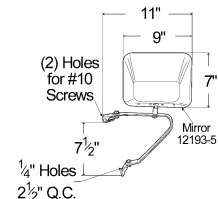

FORD* TRUCK AND VAN MIRROR ASSEMBLY

Three-screw ball swivel • Swings back against body on impact • Memory detent locks back into original position

- 28393-5** Chrome Mirror w / Anodized Aluminum Bracket, Retail Pack
- 12263-5** Mirror Only, Retail Pack

Material: Steel / Aluminum
 Reflective: 38 sq. in.
 Finish: Aluminum

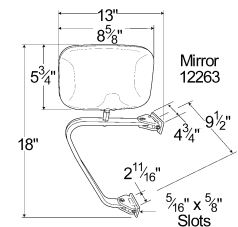

MINI-TRUCK MIRROR ASSEMBLY

Three-screw ball swivel • Fits door contours of mini-import trucks • Easy-to-mount plastic connectors • 5 1/2" x 7 1/2" mirror head

- 28252-5** Black, Powder-Coated, Retail Pack

Material: Steel
 Reflective: 33 sq. in.
 Finish: Black

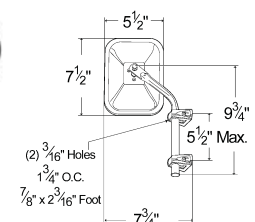

Mirrors

Rétroviseurs Espejos

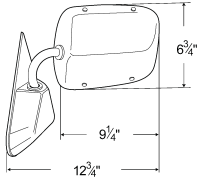

28373-5

CHEVY* / GMC* FULL-SIZE TRUCK MIRROR ASSEMBLY

Replaces vent window mirror mount original equipment on '88 to '96 Chevrolet* / GMC* full-size pickups • Mounting hardware included
• RH has convex glass

28373-5 Retail Pack

1988-1994 PICKUP:

28423-5 RH, Retail Pack

28433-5 LH, Retail Pack

Material: Stainless-Steel / Steel
Reflective: 62 sq. in.
Finish: Black

CHEVY TAHOE MIRROR ASSEMBLY

OEM-style replacement • Fits Chevy* Tahoe* 1995-1999

1995-1999 C / K PICKUP, TAHOE, SUBURBAN (1992-1999):

28812-5 RH, Electric

28822-5 LH, Electric

28832-5 RH, Manual

28842-5 LH, Manual

Material: Polycarbonate
Finish: Black



GMC JIMMY MIRROR ASSEMBLY

OEM-style replacement mirror assembly • Fits GMC* Jimmy* 1995-1997 (electric) • Fits GMC* Jimmy* 1995-1998 (manual)

1994-1998 S-SERIES TRUCK:

28852-5 RH, Electric

28862-5 LH, Electric

28872-5 RH, Manual

28882-5 LH, Manual

Material: Polycarbonate
Finish: Black

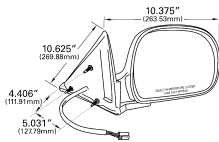

UNIVERSAL REPLACEMENT MIRROR

Lock-tight swivel • Fits both right and left side • Chrome finish • Glass cushioned in weatherproof vinyl

18103-5 Rectangular, Retail Pack

Material: DURAMOLD® / Cast Aluminum
Finish: Aluminum

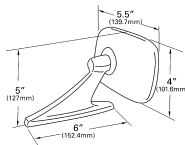

EUROPEAN WEDGE-STYLE MIRROR

Fits both right and left side

18252-5 Black, Retail Pack

Material: DURAMOLD®
Finish: Black

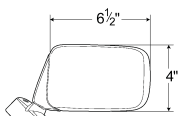

Mounting Base 4 1/2" overall L.
Mounting Holes 1 1/2" - 3 3/4" O.C.



RECTANGULAR STACK AND SPOT MIRROR

Greater coverage of blind spots • Includes arm and clamp • Painted mirrors feature rugged powder-coat finish

- 28051** White w / Arm Assembly
- 12122** Black, Mirror Only

Material: Steel
 Reflective: 20 sq. in.
 Finish: White / Black

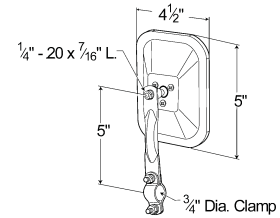

RECTANGULAR OVER-THE-DOOR CONVEX MIRROR

9/16" x 5/16" mounting holes • For "look-down" mirror applications over passenger side door

- 28763** Over Door Convex

Material: Stainless-Steel
 Reflective: 26 sq. in.
 Finish: Bright

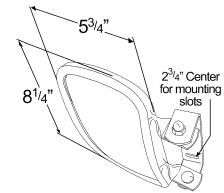

STICK-ON CONVEX MIRROR

Extends driver's view • Bonds instantly • Single-strength silvered mirror • Aluminum mirror back

ROUND:

- 12201-5** 2", Retail Pack
- 12004** 3"
- 12004-5** 3", Retail Pack
- 12014** 3 3/4"
- 12014-5** 3 3/4", Retail Pack

RECTANGULAR:

- 12164** 4" x 5 1/2"
- 12164-5** 4" x 5 1/2", Retail Pack

Material: Aluminum
 FMVSS: 111, 96 hr. corrosion test per ASTM B 117, will withstand 30-lb pull test
 Finish: Aluminum

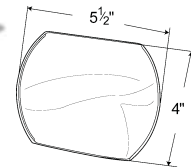

HOT SPOT MIRROR

Fits any flat surface • Weather-resistant high-strength adhesive

- 12312-5** Black, Retail Pack

Material: DURAMOLD®
 Finish: Black

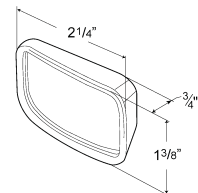

10" INSIDE REAR VIEW MIRROR

Non-glare adjustment lever • OEM styling • Includes mirror, mount, instructions and adhesive

- 18302-5** Black, Retail Pack

Material: DURAMOLD®
 Finish: Black

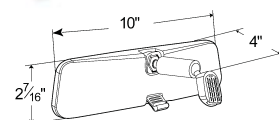

Mirrors

Rétroviseurs Espejos

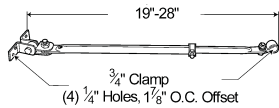

HEAVY-DUTY ADJUSTABLE BRACE ARM

19"-28" • Zinc-coated steel

10025 Zinc

Material: Stainless-Steel, Steel
Finish: Stainless

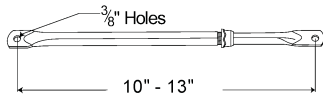

ADJUSTABLE MIRROR ARM

Painted mirrors feature rugged powder-coat finish

10" - 13" ARM:

10002 Black

14" - 22" ARM:

10012 Black

10013 Chrome

Material: Steel
Finish: Black, Chrome

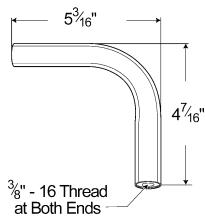

90° EXTENSION ARM

4 1/2" offset length • For use with 2809- and 2832-series mirrors

10623 Aluminum

Material: Aluminum
Finish: Polished

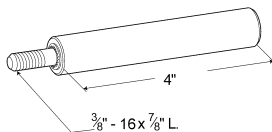

4" EXTENSION

Provides extended mirror mounting for wide loads

• Fits 2809- and 2832-style mirrors

10083 Aluminum

Material: Aluminum
Finish: Aluminum

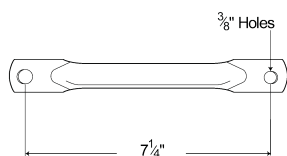

8" FLAT MIRROR ARM

Silver-metallic powder-coat finish

10045 Polished Finish, Retail Pack

Material: Steel
Finish: Steel

EXTENSION ARM AND CLAMP ASSEMBLY FOR STACK MIRRORS

10073 Stainless-Steel

Material: Stainless-Steel
Finish: Stainless

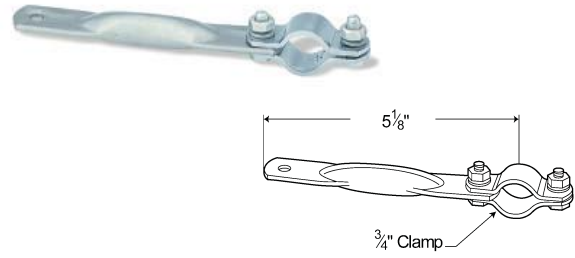

UNIVERSAL MOUNTING KIT

Complete kit includes extension arm, clamp mounting, and hardware
 • Perfect for adding on spot mirrors • Suited for 5" and 6" spot mirrors

10173 Stainless-Steel

Material: Stainless-Steel / Steel



STAINLESS-STEEL "L" BRACKET

Allows mounting of convex mirror on West Coast mirror bracket

11133 Stainless-Steel

Material: Stainless-Steel
Finish: Stainless



THROUGH-HOLE STYLE "L" BRACKET

Rugged reinforced steel construction • Perfect accessory for adding on spot mirrors
 • For 3/4" mirror arm tubing

11303 Stainless-Steel

Material: Stainless-Steel / Steel



TUBE CLAMP

Complete kit includes clamp and hardware • Perfect accessory for adding spot mirrors
 • Rugged, bright Stainless-Steel construction

11293 3/4" Clamp, 3/8" Holes

Material: Stainless-Steel



Trailer Wiring and Communications Systems

Systèmes de Communication et Filage de Remorques Sistemas de arneses para remolque / Caja de conexión



ABS POWER CORDS

Power cord meets recommended wire requirements for trailers built with ABS, starting in 1998 • Wire configuration includes an 8 gauge ground and 10 gauge red and blue • UltraLink® versions are completely sealed to prevent corrosion • Minimal voltage drop through sonic welded terminations • Stainless-steel radial springs ensure a tight grip on the pins • Plated-brass split terminals increase current-carrying capacity • Extra-tough jacket material performs -55°F to +190°F

ECONOMY CORD:

87100 1 / 8-2 / 10-4 / 12, 12', Straight, Straight
87101 1 / 8-2 / 10-4 / 12, 15', Straight, Straight

Material: Tralene
 SAE: J560b, J2222, J2394
 Finish: Green



ULTRALINK 500 POWER CORDS

Extra power delivery for single or double configurations exceeding minimum legal lamp requirements • Completely sealed to prevent corrosion • Minimal voltage drop through crimped terminations • Plated-brass split terminals increase current-carrying capacity • Extra-tough tralene jacket material performs -55°F to 190°F • 15' working-length cord available with 4' lead section (87024) • 10 gauge ground

ULTRALINK:

87020 1 / 10-6 / 12, 12', Coiled, Straight, Straight
87023 1 / 10-6 / 12, 15', Coiled, Straight, Angled

Material: Tralene
 SAE: J560
 Finish: Black



ULTRALINK 100 POWER CORDS

Superior power delivery for single or double configurations • Meet minimum legal lamp requirements • 12 gauge ground • Minimal voltage drop through crimped terminations • Plated brass split terminals increase current-carrying capacity • 15' working length cord available with 4' lead section (87044)

ECONOMY CORD:

87110 1 / 12-6 / 14, 12', Coiled, Straight, Straight
87111 1 / 12-6 / 14, 15', Coiled, Straight, Straight

Material: Tralene
 SAE: J560
 Finish: Black

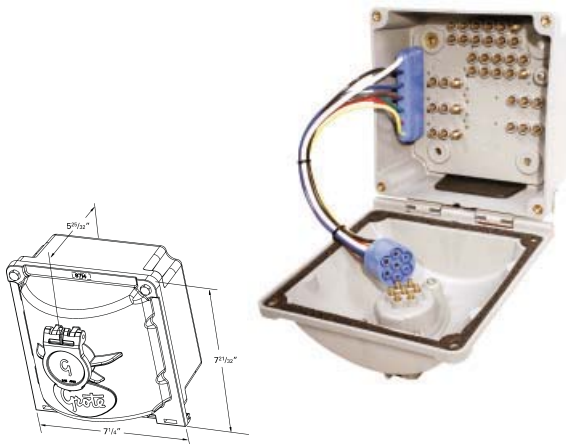

ULTRA-NOSE-BOX®

Replaceable 7-pin insert for easy maintenance • 39-pin connections eliminate overcrowding of wires • Hinged door keeps elements out, while providing easy access • Insert molded pins help prevent accidental disconnects

87140 Gray, solid pin **new**
87150 Gray, split pin **new**

Material: Nylon
 SAE: J560
 Finish: Gray
 Accessory: 7-pin insert: 97900 (solid pin), 97800 (split pin)
 Replacement Door Kit: 97910
 Pigtail: 01-6623-P9; Rubber Grommet 97810

ULTRA-PIN RECEPTACLE TWO-HOLE MOUNT

No-rust, die-cast zinc • Heavy bosses for extra rigidity • Barrel slanted to drain moisture • Mounting holes slotted for universal fit • Floating pins for easy alignment and solid mating • Two male terminals for grounding • Brass pins • 87270 includes 99510 retrofit kit • 99510 consists of 14 terminals and 9 boots

- 87250** Receptacle Only, Split Pin
- 87860** Receptacle Only, Solid Pin
- 87270** Receptacle w / Terminal Kit, Split Pin

RETROFIT KIT:

- 99510** Plug-In Terminal Kit

Material: Die-Cast Zinc
SAE: J560

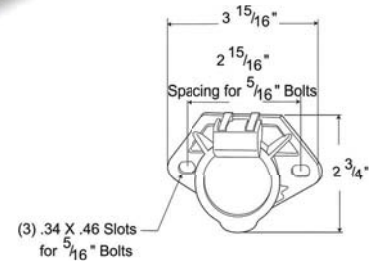

ULTRA-PIN RECEPTACLE THREE-HOLE MOUNT

No-rust, die-cast zinc • Heavy bosses for extra rigidity • Barrel slanted to drain moisture • Mounting holes slotted for universal fit • Floating pins for easy alignment and solid mating • Two male terminals for grounding • Brass Pins • 87240 includes 99510 retrofit kit • 99510 consists of 14 terminals and 9 boots

- 87240** Receptacle w / Terminal Kit, Split Pin
- 87220** Receptacle Only, Split Pin

RETROFIT KIT:

- 99510** Plug-In Terminal Kit

Material: Die-Cast Zinc
SAE: J560

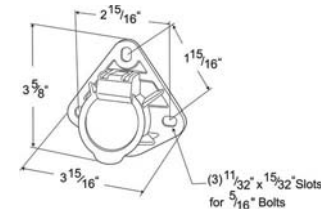

ULTRA-PIN RECEPTACLE FOUR-HOLE MOUNT NOSE BOX

Extra-heavy bosses • Slanted barrel for drainage • Floating pins for easy alignment and solid mating connection • High-impact retainer plate • Brass pins • Die-cast aluminum housing resists rust

- 87590** Solid Pin
- 87830** Split Pin

Material: Die-cast Aluminum

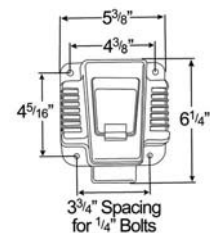

RECEPTACLE MOUNTING BOX

Mounting for 87250, 87860, 87270, 87220, 87850, 87240

- 43684** Receptacle Box

Material: Cast Aluminum

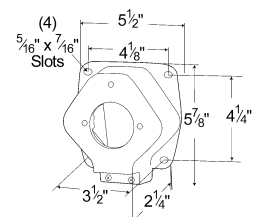

Trailer Wiring and Communications Systems

Systèmes de Communication et Filage de Remorques Sistemas de arneses para remolque / Caja de conexión

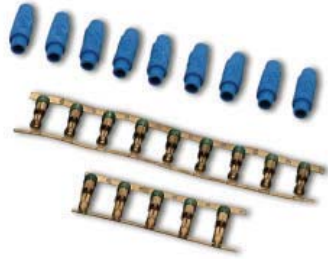

RETROFIT PLUG-IN TERMINAL KIT

Plugs into 87220, 87850, 87250, 87860, 87590 and 87830 receptacles • Kit contains 9 boots and 14 terminals • 5 terminals for larger gauge wire

RETROFIT KIT:

99510 Plug-In Terminal Kit

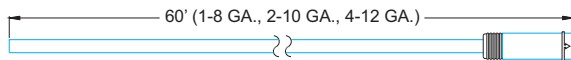

UBS MAIN HARNESS

Extends from front of trailer (nose box or receptacle) and provides sealed plug-in connection to rear sill harness

1-8 GAUGE, 2-10 GAUGE, 4-12 GAUGE:

66071 60' Long

66081 35' Long

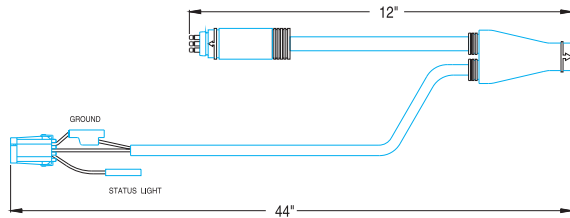

UBS MAIN HARNESS ABS ADAPTER

Junction between main harness and rear sill harness • Provides sealed plug-in connection and a drop-out extension for ABS

ABS FAULT LIGHT:

66705 12" Long

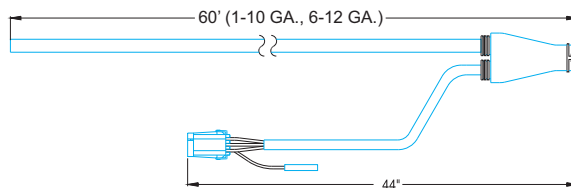

UBS MAIN HARNESS 44" ABS DROP-OUT

Provides sealed plug in connection to rear sill harness • Drop-out extends to ABS universal connector • Blunt-cut, 7-conductor cable

1-10 GAUGE, 6-12 GAUGE:

66701 60' Long

1-8 GAUGE, 2-10 GAUGE, 4-12 GAUGE:

66702 35' Long

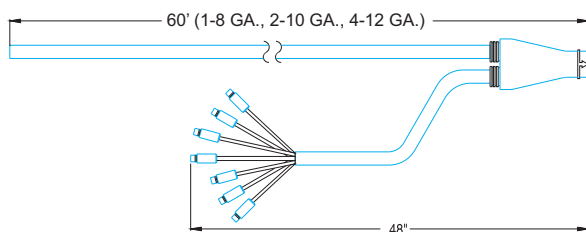

UBS MAIN HARNESS 48" DROP-OUT FOR DOUBLE-TRAILER CONNECTION

Provides sealed plug-in connection to rear sill harness • Drop-out extends to receptacle at rear of trailer • Blunt-cut, 7-conductor cable. Use only with LED lighting

1-8 GAUGE, 2-10 GAUGE, 4-12 GAUGE:

66311 60' Long

66711 35' Long

Trailer Wiring and Communications Systems

Systèmes de Communication et Filage de Remorques Sistemas de arneses para remolque / Caja de conexión

UBS HARNESS ELBOW-VERSION REAR-SILL OPTION

All connections weather-sealed by simple, foolproof UBS plugs • Entire harness double-jacketed for extra armor against road-splash and abrasion
 • Available through distributors, or it may be inventoried by fleets in service parts programs

FEMALE-PIN:	
66004	52" Long, Ground Return, ABS Connection, Ground Port
66002	52" Long, Ground Return, Blue Drop, Ground Port
66003	52" Long, Ground Return, ABS Connection, No Ground Port
MALE-PIN:	
67524	52" Long, Ground Return, ABS Connection, Ground Port
67521	52" Long, Ground Return, Blue Drop, Ground Port

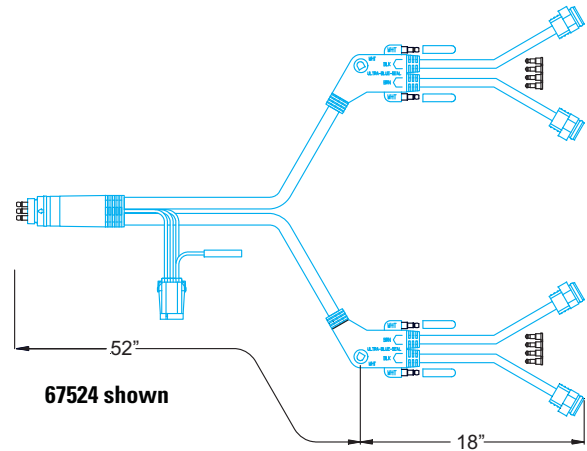

CUT-TO-FIT® WIRE HARNESS SYSTEM

The Cut-To-Fit® Wire Harness System adapts to the standard Grote Ultra-Blue-Seal® rear sill and main harness • Part number 67271 (24" standard male to Cut-To-Fit® slim-line jumper) plugs into elbow-style rear sill, making a corrosion-proof connection • Cut-To-Fit® jumpers then can be plugged directly into the double slim-line plugs • Cut-To-Fit® wire harness mates with the Grote seven pin receptacle (nose box) with the use of either the 67260 adapter or the 67250

67271	Rear Sill Adapter
67270	Ground Return Adapter
67260	Nose Box Adapter
67250	Double Nose Box Adapter

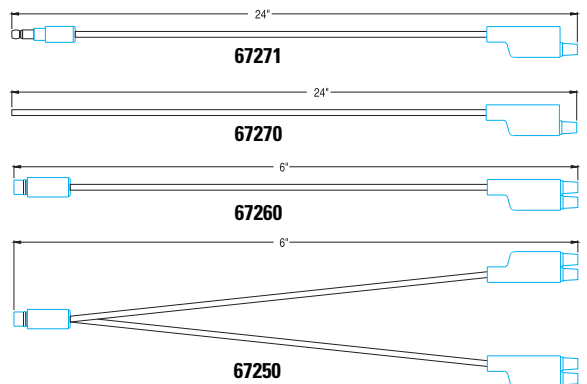

SLIM-LINE UNDER-LAMP FEMALES (CUT-TO-FIT®)

Abrasion-resistant double-jacketed wire lengths with molded-on slim-line under-lamp double females with sealing boot for crimp-on bullet connectors
 • Blunt-cut, Cut-To-Fit® wires are black

PN	WIRE SIZE	LENGTH
67301	14-gauge	3' 2" (38")
67302	14-gauge	6' 8" (80")
67303	14-gauge	14' (168")
67304	14-gauge	25' 10" (310")
67305	14-gauge	34' 7" (415")
67400	12-gauge	1' 2" (14")
67401	12-gauge	3' 2" (38")
67402	12-gauge	6' 8" (80")
67403	12-gauge	14' (168")
67404	12-gauge	25' 10" (310")
67405	12-gauge	34' 7" (415")

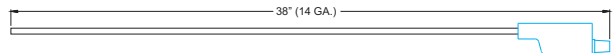

Trailer Wiring and Communications Systems

Systèmes de Communication et Filage de Remorques Sistemas de arneses para remolque / Caja de conexión

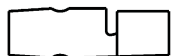

99500-3



99501-3

CRIMP-ON .180 BULLET TERMINALS

PN	WIRE SIZE
99500-3	Field Service Terminal for 14-gauge Wire
99501-3	Field Service Terminal for 12-gauge Wire



DUMMY PLUG (FOR SLIM-LINE PLUGS)

PN	DETAILS
99502	All open plugs should be sealed with a dummy plug

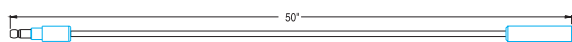

STANDARD MALE TO STANDARD FEMALE

PN	DETAILS	LENGTH
66100	License lamp jumper (as shown)	4' 4" (50")
66101	Intermediate turn signal jumper Use with 66200 from front receptacle	28' 3" (339")

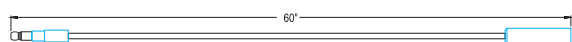

SLIM-LINE UNDER-LAMP MALE TO STANDARD FEMALE

PN	DETAILS	LENGTH
66110	Jumper to access auxiliary drop-out on rear sill harness	5' (60")

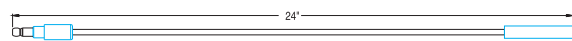

STANDARD MALE TO SLIM-LINE UNDER-LAMP FEMALE

PN	DETAILS	LENGTH
66170	Rear tracking lamp jumper	2' (24")

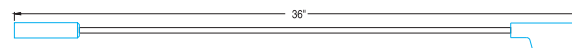

STANDARD FEMALE TO DOUBLE SLIM-LINE UNDER-LAMP FEMALE

PN	DETAILS	LENGTH
66225	Ground jumper	3' (36")

Trailer Wiring and Communications Systems

Systèmes de Communication et Filage de Remorques Sistemas de arneses para remolque / Caja de conexión

SLIM-LINE UNDER-LAMP MALE TO SLIM-LINE UNDER-LAMP FEMALE

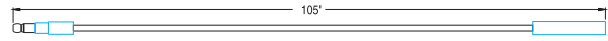

PN	DETAILS	LENGTH
66162	Intermediate side-marker crossover jumper	8' 9" (105")

SLIM-LINE UNDER-LAMP MALE TO SLIM-LINE UNDER-LAMP FEMALE

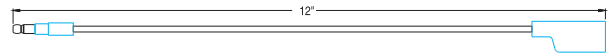

PN	DETAILS	LENGTH
66160	Multiple ID lamp jumper	1' (12")
66124	Front marker and rear marker lamp jumper	2' 6" (30")
66161	Front lower side-marker from front receptacle. Use with 66190	4' 7" (55")
66125	Marker lamp jumper	7' (84")
66123	Marker lamp jumper	10' 9" (129")
66163	Front upper clearance / marker from front receptacle. Use with 66190	12' 8" (152")
66122	Marker lamp jumper	16' (192")
66113	Clearance lamp jumper	26' 11" (323")

BLUNT-CUT TO DOUBLE SLIM-LINE UNDER-LAMP FEMALE

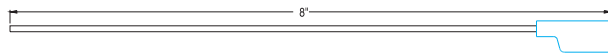

PN	DETAILS	LENGTH
66190	Wire into front receptacle terminals	8" blunt cut

BLUNT-CUT TO STANDARD FEMALE

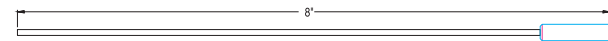

PN	DETAILS	LENGTH
66200	Wire into front receptacle terminals	8" blunt cut

BLUNT-CUT TO SLIM-LINE UNDER-LAMP FEMALES

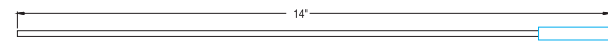

PN	WIRE SIZE	LENGTH
67315	14-gauge	1' 2" (14")
67413	12-gauge	1' 2" (14")

DOUBLE SLIM-LINE FEMALE TO RING TERMINAL

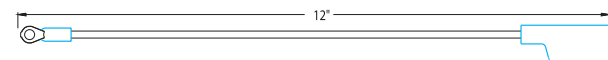

PN	DETAILS	LENGTH
66210	Jumper to accommodate insulated ground return system. Affixed to brass ground on rear sill harness. Crimp-on 1/4" ring terminal and heat-shrink tube supplied, unattached	12"

Trailer Wiring and Communications Systems

Systèmes de Communication et Filage de Remorques Sistemas de arneses para remolque / Caja de conexión

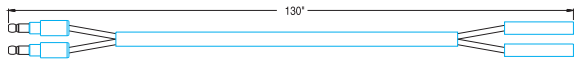

TWO STANDARD MALES TO TWO SLIM-LINE UNDER-LAMP FEMALES

PN	DETAILS	LENGTH
66220	ID / auxiliary stop jumper: Use with 5306 combination clearance / marker and auxiliary stop / turn signal lamp. Use with 66400 when triple-ID / Auxiliary stop is located on upper rail	10' 10" (130")
66121	Mid-turn and marker lamp harness	30' (360")
66104	Mid-turn and marker lamp harness	31' 2" (374")
66105	Mid-turn and marker lamp harness	35' 4" (424")

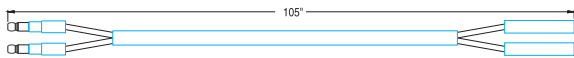

TWO SLIM-LINE MALES TO TWO SLIM-LINE UNDER-LAMP FEMALES

PN	DETAILS	LENGTH
66221	Marker lamp or ABS fault lamp	5' (60")
66222	Jumper	8' (96")
66164	Jumper	8' 9" (105")

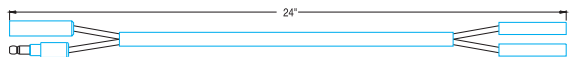

STANDARD MALE / STANDARD FEMALE TO TWO SLIM-LINE UNDER-LAMP FEMALES

PN	DETAILS	LENGTH
66223	Ground-return tracking harness	2' (24")
66224	Ground-return tracking harness	3' (36")

**Use with elbow-style rear sill*

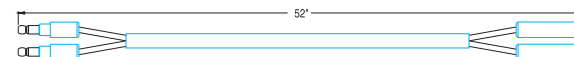

TWO STANDARD MALES TO TWO STANDARD FEMALES

PN	DETAILS	LENGTH
66133	Marker lamp jumper	4' 4" (52")

Trailer Wiring and Communications Systems

Systèmes de Communication et Filage de Remorques Sistemas de arneses para remolque / Caja de conexión

TWO STANDARD MALES TO TWO DOUBLE FEMALES

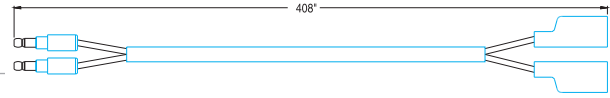

PN	DETAILS	LENGTH
66171	Marker-lamp jumper	14' (168")
66145	Marker-lamp jumper	26' (312")
66143	Marker-lamp jumper	31' (372")
66141	Marker-lamp jumper	34' (408")

TWO SLIM-LINE MALE TO TWO DOUBLE FEMALES

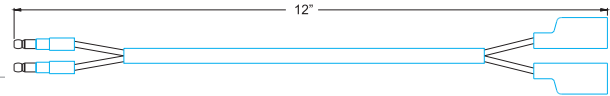

PN	DETAILS	LENGTH
66165	Marker-lamp jumper	1' (12")
66155	Marker-lamp jumper	2' 6" (30")
66154	Marker-lamp jumper	4' 7" (55")
66153	Marker-lamp jumper	7' (84")
66152	Marker-lamp jumper	10' 9" (129")
66151	Marker-lamp jumper	12' 8" (152")
66150	Marker-lamp jumper	16' (192")
66135	Marker-lamp jumper	26' 11" (323")

WIRING KIT FOR VANS

Contains all lamp jumper harnesses and pigtails to plug all rear lights into rear sill harness (elbow-style).

PN	DETAILS
66510	Kit for field-resealable lamp system

Kit includes the following components:

- (1) **66100** For use as license lamp harness
- (2) **66170** For use as tracking lamp harnesses
- (1) **66180** For use as identification lamp harness
- (2) **66160** For use as identification lamp extension harnesses (as shown)
- (5) **67120** Lamp pigtails for factory-sealed systems or for field re-sealable systems

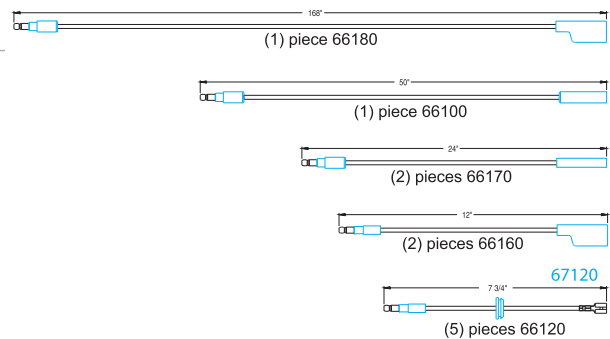

Pigtails, Brackets and Grommets

Spirales de Raccord, Bague de Montage et Supports Conectores / Soportes rígidos y flexibles



66930



66931

THIN-LINE LED PIGTAILS

UBS sealing ring • Uses patented double-seal protection • Grease grooves for additional sealing protection • Factory molded plugs for use with ULTRA-BLUE-SEAL® trailer wiring system • Slim-line .180 male

66930 5" Long, Chassis Ground System

66931 6" Long, Ground Return



67001



66850



66851



66801



67050

SEALED MARKER LAMP PIGTAILS

Factory molded plugs for use with ULTRA-BLUE-SEAL® trailer wiring system • Double seal resists corrosion • Fits 2", and 2 1/2" round and beehive style LED and incandescent lamps • Slim-line .180 male

DOUBLE SEAL:

67001 6" Long, Ring Terminal Ground, Blunt-Cut Wire

67001-5 6" Long, Ring Terminal Ground, Blunt-Cut Wire, Retail Pack **new**

66850 6" Long, Chassis Ground

66851 6" Long, Ground Return

SINGLE SEAL:

66801 6" Long, Ground Return

67050 6" Long, Ring Terminal Ground, Blunt-Cut Wire

67050-5 6" Long, Ring Terminal Ground, Blunt-Cut Wire, Retail Pack **new**

66800 6" Long, Chassis Ground, Slim-line .180 Male

66840 6" Long, Chassis Ground, Standard .180 Male



66800



66840



66980



66981



66982

CLEARANCE / MARKER PIGTAILS

Fits 4674 series clearance / marker lamps, and 4709 and 6029 / 6030 license and utility lamps • Factory-molded plugs for use with ULTRA-BLUE-SEAL® trailer wiring system • Pigtail designed to be integral part of mounting bracket (43780)

66980 6" Long, Chassis Ground, Slim-line .180 Male

66981 6" Long, Universal Replacement, Blunt-Cut, Ring Terminal

66982 8" Long, Ground Return



67120

MARKER LAMP PIGTAIL

Fits all Grote 2-bulb marker lamps with flag terminals, including 4526-, 4546-, 4593-, 4630-, 4678- and 4679-series lamps

67120 7 3/4" Long, .180 Slim-line Male

Pigtails, Brackets and Grommets

Spirales de Raccord, Bague de Montage et Supports Conectores / Soportes rígidos y flexibles

SEALED, ECONOMY CLEARANCE / MARKER LAMP PIGTAIL

Fits 4607 lamps

66360 6 3/4" Long w / 3/8" Wire Strip



TURTLEBACK® II DOUBLE-SEAL LAMP PIGTAILS

Pigtail for 4680-, 4684-, 4686- and 4687-series lamps • All connections fit under lamps • Factory molded plugs for use with ULTRA-BLUE-SEAL® trailer wiring system

- 66910** 6" Long, Chassis Ground, Slim-line .180 Male
- 66911** 6" Long, Ground Return, Standard .180 Male
- 67070** 2 1/2" Long, Ground Wire, Standard .180 Male
- 67071** Two-Wire, Standard .180 Male



66910



66911



67070



67071

SENTRY LAMP PIGTAILS

Sealed plug-in pigtail for 5206, 5202, and 5306 lamps • Factory-molded plugs for use with ULTRA-BLUE-SEAL® trailer wiring system • O-ring helps prevent moisture and corrosion

- 66900** 6" Long, Chassis Ground, Slim-line .180 Male, 3 1/2" Ground, Star Ring Terminal
- 66903** Three Wire, Standard .180 Male (5306 Lamps Only)
- 66904** 6" Long, Ground Return, Slim-line .180 Male
- 66905** 6" Long, Chassis Ground, Slim-line .180 Male



66900



66903



66905



66904

SENTRY, LAMP SINGLE FUNCTION 90° PIGTAIL

90° molded plug at lamp • Packard connector at power end (15300027)
• O-ring resists moisture and corrosion

66920 30" Long, 90° Plug



Pigtails, Brackets and Grommets

Spirales de Raccord, Bague de Montage et Supports Conectores / Soportes rígidos y flexibles



HIGH MOUNT STOP LAMP PIGTAIL

Fits 4925 series lamps for use in HMSL applications • Factory-molded plugs for use with the ULTRA-BLUE-SEAL® trailer wiring system

66870 12" Long, Slim-line .180 Male **new**



SENTRY HIGH-MOUNT STOP PIGTAIL

Fits 54012 lamp • Sealing-ring to lamp base • O-ring resists moisture and corrosion

66902 6" Long, Slim-line .180 Male, 3" Ground, Star Ring Terminal



66815



66841



67002

STOP /TAIL /TURN THREE-WIRE PLUG-IN PIGTAILS FOR MALE-PIN LAMPS

Dual function for S / T / T lamps • O-ring seal resists moisture and corrosion • Quality ULTRA-BLUE-SEAL® construction • Grease grooves for additional sealing protection

66815 6" Long, Ground Return System, Slim-line .180 Male

66841 8" Long, Chassis Ground, Slim-line .180 Male

67002 11" Long, Chassis Ground, Blunt-Cut Wire



66816



66845



67005

STOP /TAIL /TURN THREE-WIRE 90° PLUG-IN PIGTAILS FOR MALE PIN LAMPS

Dual function for S / T / T lamps • O-ring seal resists moisture and corrosion • 90° plug for reduced clearance applications • Quality ULTRA-BLUE-SEAL® construction • Grease grooves for additional sealing protection

66816 6" Long, Ground Return System, 90° Plug, Slim-line .180 Male

66845 8" Long, Chassis Ground, 90° Plug, Slim-line .180 Male

67005 11" Long, Chassis Ground, 90° Plug, Blunt-Cut Wires



67013



66842

STOP /TAIL /TURN TWO-WIRE PLUG-IN PIGTAILS FOR MALE-PIN LAMPS

Straight-in pigtail • Single function • O-ring seal resists moisture and corrosion • Quality ULTRA-BLUE-SEAL® construction • Grease grooves for additional sealing protection

67013 11" Long, Chassis Ground, Blunt-Cut Wire

66842 10" Long, Chassis Ground, Slim-line .180 Male

STOP /TAIL /TURN TWO-WIRE 90° PLUG-IN PIGTAILS FOR MALE-PIN LAMPS

90° plug for reduced clearance applications • Single function • O-ring seal resists moisture and corrosion • Grease grooves for additional sealing protection • Factory molded plugs for use with quality ULTRA-BLUE-SEAL® trailer wiring system

- 66846** 10" Long, Chassis Ground, 90° Plug, Slim-line .180 Male
- 67016** 11" Long, Chassis Ground, 90° Plug, Blunt-Cut Wires

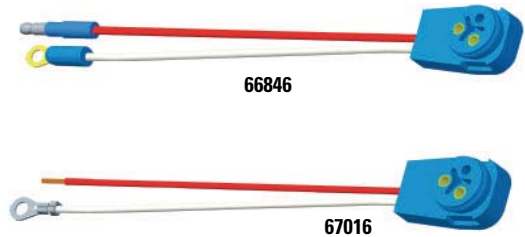

STOP /TAIL /TURN THREE-WIRE PLUG-IN PIGTAILS FOR FEMALE-PIN LAMPS

Dual function for S / T / T lamps • Factory molded plugs for use with ULTRA-BLUE-SEAL® trailer wiring system

- 66812** 6" Long, Chassis Ground, Slim-line .180 Male
- 66825** 8" Long, Ground Return, Slim-line .180 Male
- 67000** 11 1/2" Long, Chassis Ground, Blunt-Cut Wires

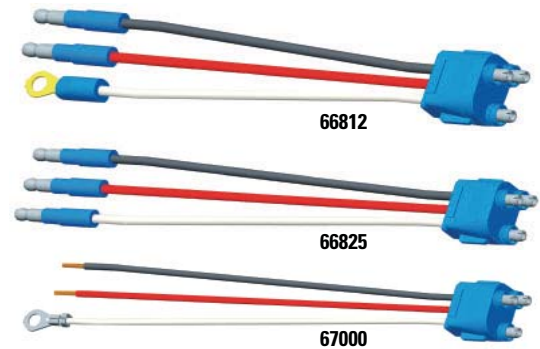

STOP /TAIL /TURN THREE-WIRE 90° PLUG-IN PIGTAILS FOR FEMALE-PIN LAMPS

Dual function for S / T / T lamps • Factory-molded plugs for use with ULTRA-BLUE-SEAL® trailer wiring system

- 66811** 18" Long, Chassis Ground, Slim-line .180 Male, Star Ring Terminal
- 66843** 18" Long Chassis Ground, Blunt-Cut Wires, Star Ring Terminal
- 66843-5** 18" Long Chassis Ground, Blunt-Cut Wires, Star Ring Terminal, Retail Pack new
- 66844** 18" Long, Ground Return, Slim-line .180 Male

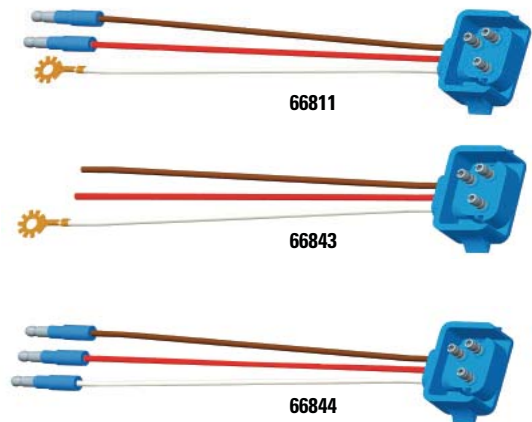

ECONOMY 3-WIRE 90° PLUG-IN PIGTAIL FOR FEMALE-PIN LAMPS

90° construction for reduced clearance applications • Dual function for S / T / T lamps • Mates to Grote® and competitive lamps with female termination

- 67090** 11" Long, Chassis Ground, 90° Plug, Blunt-Cut Wires
- 67090-5** 11" Long, Chassis Ground, 90° Plug, Blunt-Cut Wires, Retail Pack new



Pigtails, Brackets and Grommets

Spirales de Raccord, Bague de Montage et Supports Conectores / Soportes rígidos y flexibles

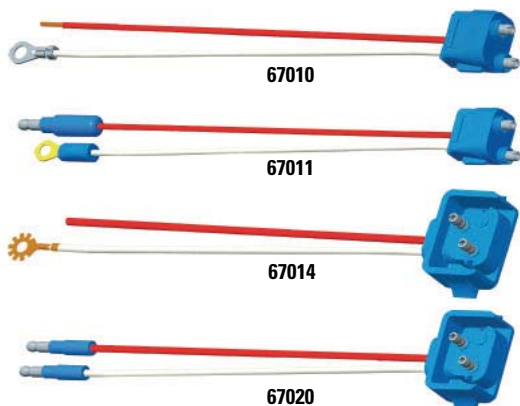

TWO-WIRE PLUG-IN PIGTAILS FOR FEMALE-PIN LAMPS

Single function • Factory molded plugs for use with ULTRA-BLUE-SEAL® trailer wiring system

STRAIGHT:

67010 11 1/2" Long, Chassis Ground, Blunt-Cut
67011 10 1/4" Long, Chassis Ground, Standard .180 Male

90° PLUG:

67014 10" Long, Chassis Ground, Blunt-Cut
67020 10" Long, Ground Return, Slim-line .180 Male

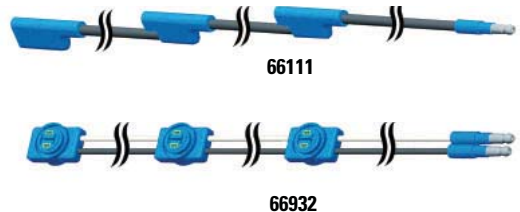

TRIPLE-LAMP ID HARNESSSES

Designed for use with ULTRA-BLUE-SEAL® wiring system • Factory-molded plugs resist moisture and corrosion • Slim-line .180 male terminations at power end

66111 54" Long, Universal Triple-ID Jumper (30"x12"x12")
66932 60" Long, LED Triple-ID Jumper (36"x12"x12")

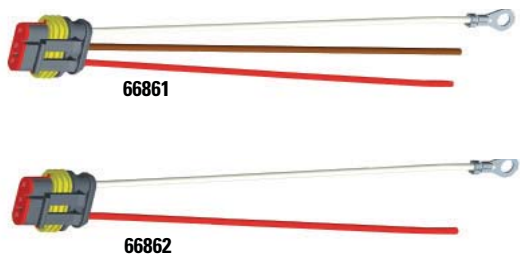

HARD-SHELL CONNECTOR PIGTAILS

Mates with competitive lamps using Amp Superseal® 1.5 series connectors

DUAL FUNCTION:

66861 11" Long, Chassis Ground, Blunt-Cut Wires

SINGLE FUNCTION:

66862 11" Long, Chassis Ground, Blunt-Cut Wires



PACKARD* CONNECTOR PIGTAIL

Sealed plug-in style pigtail for Grote® Hybrid Mid-turn / Marker LED lamp 5242

66826 6" Long, Slim-line .180 Males



METRI-PACK* PLUG-IN SEALED PIGTAIL

Fits either 4- or 5-wire applications • Fits 5370-, 5371-, 5372- and 5376-series lamps

66880 20" Long, Sealed, Blunt-Cut Wires

Pigtails, Brackets and Grommets

Spirales de Raccord, Bague de Montage et Supports Conectores / Soportes rígidos y flexibles

TWO LAMP 9" "Y" ADAPTER PIGTAILS

Accommodates 6-lamp systems • Molded termination avoids moisture and corrosion buildup • For use with 4" round and oval S / T / T, lamps
 • Retrofits to superior Grote male-pin LEDs and lamps without the need for new wiring

90° PLUG:
66814 Adapter, Female- to-Male-Pin

STRAIGHT:
66810 Adapter, Female-to-Female-Pin
66813 Adapter, Male- to-Male-Pin

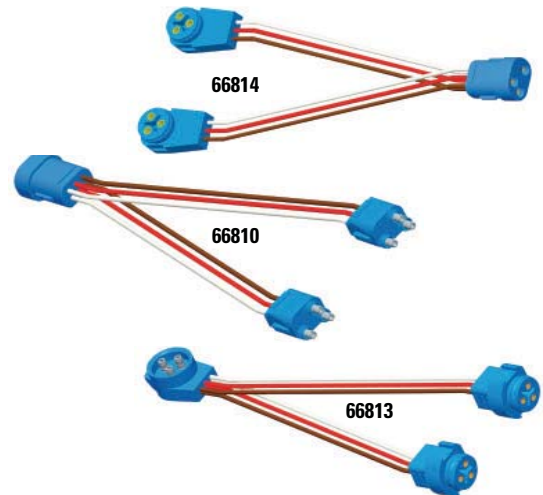

MID-TURN ADAPTER PIGTAILS

6" mid-turn turn adapter harness • Factory-molded-plugs for use with ULTRA-BLUE-SEAL® trailer wiring system • For use with 4" round and oval S / T / T lamps • Dummy plug in brown female .180 receptacle

66820 Adapter, Female-to-Female-Pin, (2) Additional Standard .180 Receptacles
66823 Adapter, Male-to-Male-Pin, (2) Additional Standard .180 Receptacles



ADAPTER PLUGS

Options or female-to-male-pin lamp termination, and male to female-pin lamp termination • For use with 4" round and oval, S / T / T lamps

66830 6" Long, Female-Pin to Male-Pin Lamp Termination
66831 6" Long, Male-Pin to Female-Pin Lamp Termination
66836 6" Long, Female-Pin to 90° Male-Pin Lamp Termination

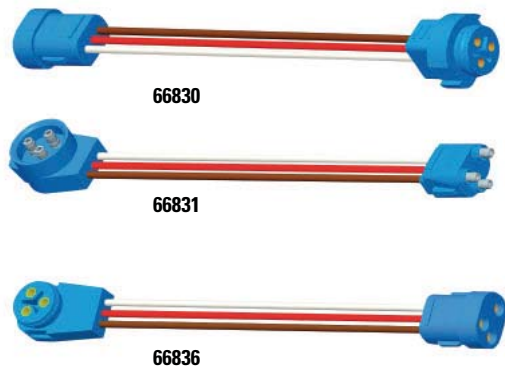

ADAPTER PLUGS FOR HARD-SHELL CONNECTORS

For use with 4" round and oval S / T / T lamps

COMPETITIVE HARNESS TO MALE-PIN:
66860 Female-Pin to Hard-Shell Connector **new**

FEMALE-PIN HARNESS TO AMP CONNECTOR:
67006 Hard-Shell to Male-Pin Connector

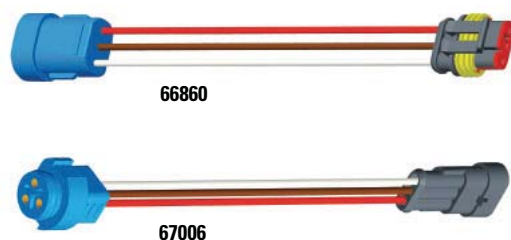

Pigtails, Brackets and Grommets

Spirales de Raccord, Bague de Montage et Supports Conectores / Soportes rígidos y flexibles



REPLACEMENT LAMP SOCKET PIGTAILS

Ensures positive bulb contact in all types of weather • Exceeds all existing automotive requirements • Heavy-gauge thermoplastic wire with brass contacts, terminals and flags

DOUBLE CONTACT:

68110	9 1/2" Long
68130	7 1/2" Long
68150	6 1/2" Long

SINGLE CONTACT:

68080	9 1/2" Long
68100	9 1/2" Long
68170	9 1/2" Long



TWIST-IN SOCKET PIGTAIL

Includes 194 bulb • Fits 46002, 46003, 46913, 45662, 45563, 45712, and 45713 marker lamps

68380 9 1/2" Long, Socket, Blunt-Cut Wires

Volts / Amps: 12 V - .27 A

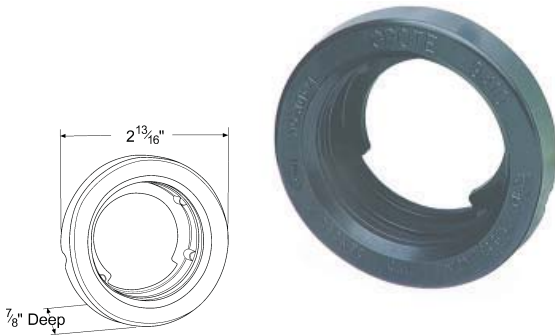

2 5/16" HOLE GROMMET

Fits 2" round lamps • Fits panel thickness up to 1/4"

92120	Open Grommet
92150	Closed Back Grommet

KITS:

94100	Open Grommet (92120 + 67050)
--------------	------------------------------

Material: PVC
Finish: Black



SNAP-IN THEFT-RESISTANT FLANGE FOR 2" ROUND LAMPS

Snap-in flanges make installation more efficient into a variety of situations

• Lamp snaps into the flange and flange snaps into the trailer body, making it more difficult for a thief to remove the lamps • Requires a 2 5/16" hole and panel thickness from 1/16" up to 1/4" thick

42190	Gray
42192	Black new
42193	Chrome new

CAP:

93860	Gray
--------------	------

CAP AND FLANGE KITS:

65650	Gray (42190 + 93860)
--------------	----------------------

Material: Polycarbonate / ABS
Finish: Gray / Chrome / Black

THEFT-RESISTANT MOUNTING FLANGE FOR 2" ROUND LAMPS

Patented twist-in locking system keeps lamp from backing out • Ideal for LED lighting • Fits 2" LED and incandescent lamps • Requires 2 1/8" hole

- 43150** Gray, Polycarbonate
- 43152** Black, Polycarbonate
- 43153** Chrome-Plated, ABS

SECURITY RING:
43463 Stainless-Steel

Material: Polycarbonate / ABS
 Finish: Gray / Black / Chrome

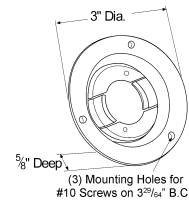

MOUNTING BRACKET AND GROMMET FOR 2" ROUND LAMPS

Fits 2" round lamps • Includes grommet 92120 • 4 3/4" hole spacing

- 93760** Gray

Material: DURAMOLD® / PVC
 Finish: Gray

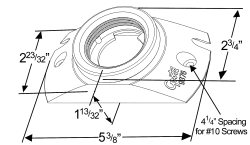

LICENSE LAMP MOUNTING BRACKET

Accepts 2" round lamps • Anti-glare shield eliminates light to rear of vehicle

- 43040** White

Material: Polycarbonate
 Finish: White

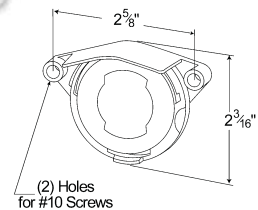

2 25/32" HOLE GROMMET

Fits 2 1/2" round lamps • For use when increased visibility is preferred • Lamp projects slightly above grommet line • Fits panel thickness up to 1/8"

- 91400** Open Grommet
- 92070** Closed Back Grommet

KITS:
94010 Open Grommet (91400 + 67050)

Material: PVC
 Finish: Black

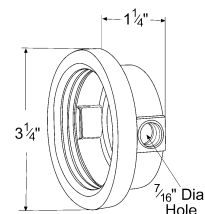

Pigtails, Brackets and Grommets

Spirales de Raccord, Bague de Montage et Supports Conectores / Soportes rígidos y flexibles

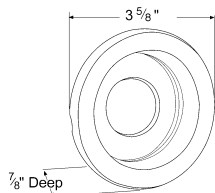

3" HOLE GROMMET

Fits 2 1/2" round lamps • Recessed lens-protective mounting • Fits panel thickness up to 1/4"

91410 Open Grommet

KITS:

94000 Open Grommet (91410 + 67050)

Material: PVC
Finish: Black

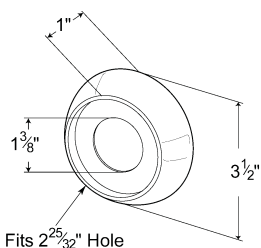

45° ANGLED BEVELED-EDGE MOUNTING GROMMET

Converts 4581 series into clearance / marker lamp applications • Meets PC requirements • Fits 2 3/4" hole • Open back fits panel thickness up to 3/16" closed back fits up to 3/8" • Fits all 2 1/2" round lamp

91880 Open Grommet

92920 Closed Back Grommet

Material: PVC
Finish: Black

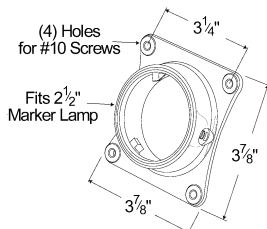

GROMMET FOR SURFACE- OR FLUSH-MOUNT LAMPS

Fits 2 1/2" round lamps • Meets PC requirements

91890 Open Grommet

Material: PVC
Finish: Black

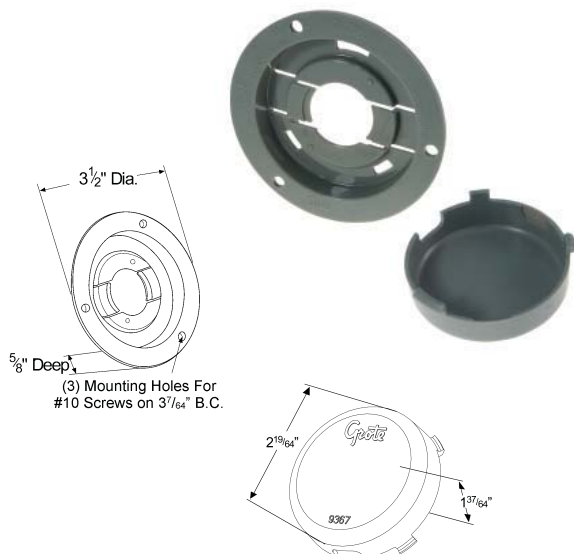

THEFT-RESISTANT MOUNTING FLANGES AND PIGTAIL RETENTION CAPS FOR 2 1/2" ROUND LAMPS

Patented twist-in locking system keeps lamp from backing out • Ideal for LED lighting • Fits 2 1/2" LED and incandescent lamps • Pigtail retention cap keeps pigtails from backing away from lamp • Requires 2 5/8" hole

43160 Gray, Polycarbonate

43162 Black, Polycarbonate

43163 Chrome-Plated, ABS

CAP:

93670 Gray

CAP AND FLANGE KITS:

65590 Gray (43160 + 93670)

65592 Black (43162 + 93670)

SECURITY RING:

43823 Stainless-Steel

Material: Polycarbonate / ABS
Finish: Gray / Black / Chrome

SNAP-IN MOUNTING FLANGE FOR 2 1/2" LAMPS

Flange is held into place by snap tabs (as opposed to standard screw holes) for a quicker, easier installation • Snap tabs on the flange lock the flange into place, keeping it from backing out of the hole • Foam gasket allows for mounting in materials from .120" to .250" thick • No drilling to install; helps reduce installation time by more than 60% • Requires 2 25/32" hole

- 42170 Gray **new**
- 42172 Black **new**
- 42173 Chrome **new**

CAP:	
93860	Gray
SECURITY RING:	
43823	Stainless-Steel

Material: Polycarbonate
Finish: Gray / Black / Chrome

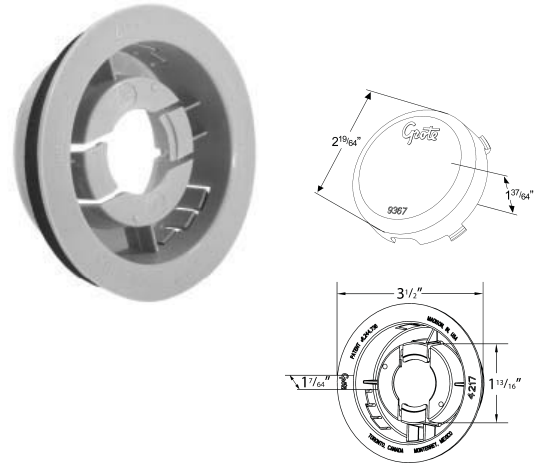

MOUNTING BRACKET AND GROMMET FOR 2 1/2" ROUND LAMPS

Fits 2 1/2" round lamps • Includes grommet 91400 • 4 3/4" hole spacing

- 93750 Gray

Material: DURAMOLD® / PVC
Finish: Gray

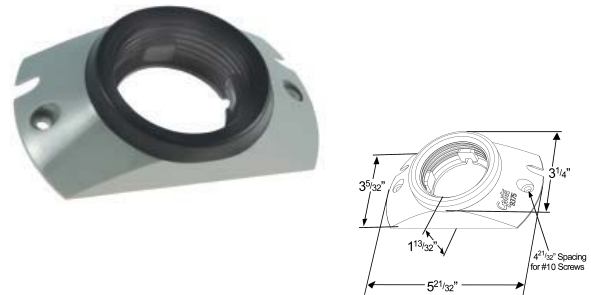

TWIST-ON, SURFACE-MOUNTING BRACKET

Fits 2" and 2 1/2" lamps • Meets PC requirements • Accepts LED or incandescent lamps

- 43690 Gray

KITS:	
43430	Gray (43690 + 67050)
43430-5	Gray (43690 + 67050), Retail Pack new

Material: Polycarbonate
Finish: Gray

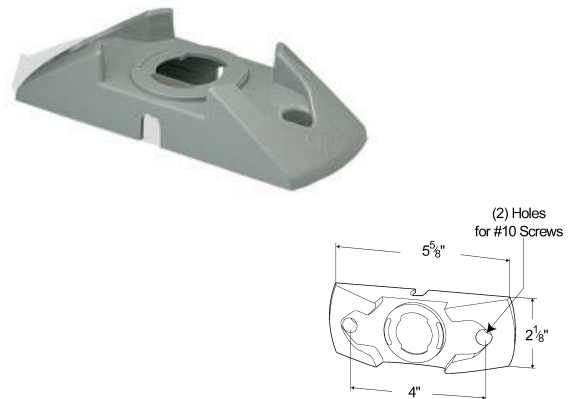

4 5/8" RADIUS CORNER BRACKET FOR 2" AND 2 1/2" LAMPS

Fits 2" and 2 1/2" round lamps • Extra rigid construction keeps lamp from backing out of bracket • Fits 4 5/8" corner radius • Use with PC-rated lights

- 43760 Gray

Material: Polycarbonate
Finish: Gray

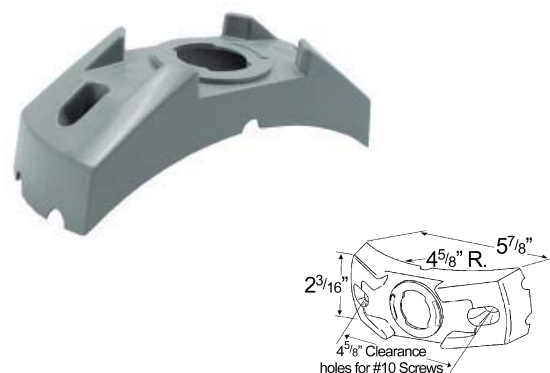

Pigtails, Brackets and Grommets

Spirales de Raccord, Bague de Montage et Supports Conectores / Soportes rígidos y flexibles

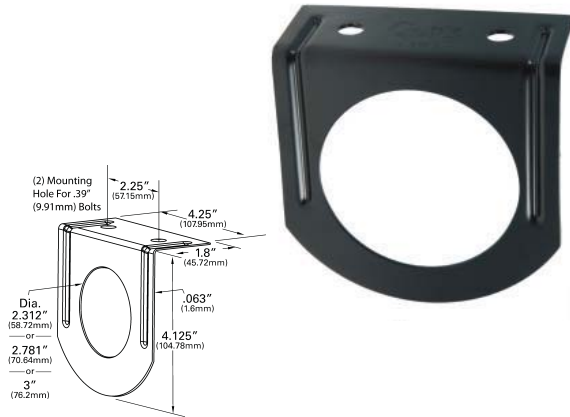

MOUNTING BRACKETS FOR 2" AND 2 1/2" LAMPS

Fits 2" and 2 1/2" round lamps • Heavy-gauge steel • Baked black enamel finish • Grommet required for mounting

FOR 2 1/2" LAMPS:

43512 Accommodates 94010, 91400, 92070 Grommets (2 25/32" Hole)

43522 Accommodates 94000, 91410 Grommets (3" Hole)

FOR 2" LAMPS:

43532 Accommodates 94100, 92120, and 92150 Grommets (2 5/16" Hole)

Material: Steel
Finish: Black Enamel



TWIST-ON SURFACE MOUNT BRACKET

Allows for easy surface mounting of clearance / marker lamps without punching recess holes • Flexible mounting options accepts both 2" and 2 1/2" round lamps • 3" mounting centers • Nickel-plated brass eyelets increase strength and durability • Not recommended for use with Signal-Stat* products • Supports the use of PC-rated lamps for greater visibility

42180 Gray **new**

Material: Polycarbonate
Finish: Gray

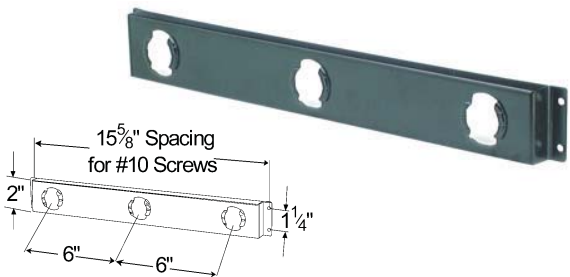

BAR-LAMP BRACKET FOR 2" AND 2 1/2" ROUND LAMPS

Accepts 2" and 2 1/2" twist-on lamps • Black powder-coated • Includes chassis-ground UBS harness with blunt-cut power feed

49140 Black

Material: Steel
Finish: Black Enamel
Accessory: Harness: 67740



GROMMET FOR SMALL RECTANGULAR LAMPS

Fits small rectangular 4641-, 4516-, 4708- and G150-series lamps • Requires 1 1/2" x 2 7/8" hole (with 3/8" radius corners)

91380 Black

Material: PVC
Finish: Black



GROMMET FOR 2 1/2" OVAL LAMP

Fits 2 1/2" oval style lamps 45002-5, 45003-5, 47012, 47013, 45242-5 and 45243-5 • 2 1/2" x 3 1/2" hole (with 17/32" corners) • Fits panel thickness up to 3/16"

91060 Black

Material: PVC
Finish: Black

GROMMET FOR SMALL RECTANGULAR CLEARANCE / MARKER LAMPS

Fits 4750 and 4523 lamps • Fits 2 1/2" x 3 1/2" Hole

- 93400 White
- 93402 Black

Material: PVC
Finish: Black / White

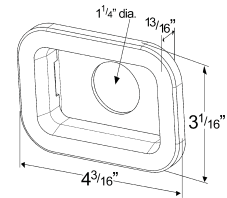

CLEARANCE MARKER BRACKET FOR SMALL RECTANGULAR LAMPS

Fits 4708, 4641, 4516 and G150 lamps • Kits include pigtail and mounting pad

- 94233 Chrome **new**

- KITS:**
- 43970 Gray, with pigtail
 - 43980 Chrome, with pigtail

Material: ABS
Finish: Chrome

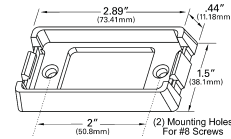

RAIL-MOUNT BRACKET KIT FOR CLEARANCE / MARKER LAMPS

Fits 4708, 4641 and 4561 lamps • Mountable at 45° angle for PC applications • Includes single-seal pigtail • Cut-out design for rail mountings

- 42131 White, Bracket Only **new**

- KITS:**
- 43370 White (42131 + 67050)

Material: Polycarbonate
Finish: White

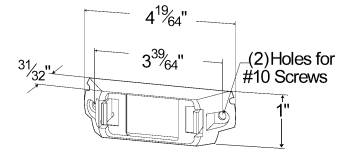

CORNER-MOUNT BRACKET

Corner trailer mounting • Can be used with competitive lamp models • For use with PC-rated lights • Molded 4 3/8" radius base

- 43050 Gray

Material: Polycarbonate
Finish: Gray

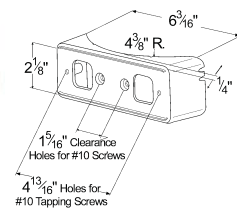

HEADER-MOUNT BRACKET KIT FOR CLEARANCE / MARKER LAMPS

Fits 4708, 4641, and 4516 lamps • Mountable at 45° angle for PC applications • Includes single-seal pigtail • Narrow rail applications

- 42141 White, Bracket Only **new**

- KITS:**
- 43380 White (42141 + 67050) **new**

Material: Polycarbonate
Finish: White

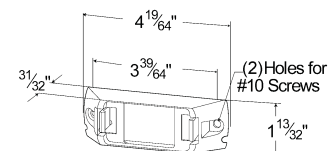

Pigtails, Brackets and Grommets

Spirales de Raccord, Bague de Montage et Supports Conectores / Soportes rígidos y flexibles



2 1/2" OVAL CLEARANCE / MARKER BEZEL

Fits 2 1/2" oval clearance / marker lamps 4701, 4500 and 4527

43883 Chrome

Material: Polycarbonate
Finish: Chrome

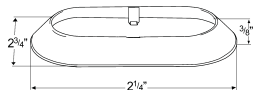

SURFACE MOUNT BRACKET FOR MICRONOVA®

Surface-mount bracket for Grote® MicroNova® products • Armored design to protect the lamp from obstruction damage (like tree limbs) • 3" mounting centers for easy retrofit to many popular marker lamps

42110 Gray **new**

Material: Polycarbonate
Finish: Gray

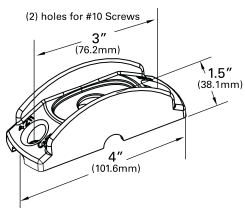

MICRONOVA® LAMP BEZEL

Fits Grote® MicroNova® Clearance / Marker LED lamps 4528 • Corrosion-resistant, chrome-plated • Sleek aerodynamic styling

93803 Chrome
94220 Gasket

Material: Polycarbonate / ABS
Finish: Chrome

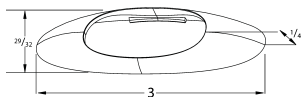

LICENSE LAMP BRACKET

Versatile mounting bracket for license lamp applications • 3" mounting centers • Anti-glare shield eliminates light to rear of vehicles

42160 Gray **new**
42162 Black **new**

Material: Polycarbonate
Finish: Gray / Black

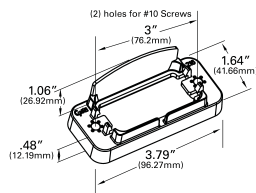

MOUNTING BRACKET

Features a snap-fit mounting for quick installation and easy replacements • Fits license lamp 60261, 60601 • Ideal for license, instrument and step-lighting applications

43960 Gray
43962 Black **new**

Material: Polycarbonate
Finish: Gray / Black

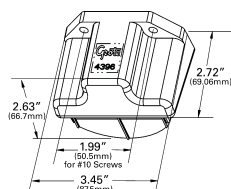

MOUNTING BRACKET

Fits license lamp 60261, 60291 • Ideal for license, instrument and step-lighting applications • Thin design reduces mounting space requirements

43830 Gray

Material: Polycarbonate
Finish: Gray
Grommet: 92520

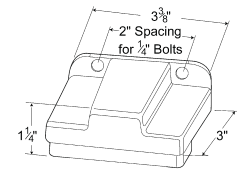

MOUNTING BRACKET FOR CLEARANCE / MARKER LAMPS

Integral mounting bracket for 4709, 4749, G190, 4674, 4514 lamps
• Molded polycarbonate for long life • Unique connector design with plug-in pigtail

43780 Gray Bracket
43783 Chrome Bracket

KITS:

43390 Gray (43780 + 66981)
43790 Gray (43780 + 66980)

Material: Polycarbonate / ABS
Finish: Gray / Black / Chrome
Pigtail: 66980, 66981

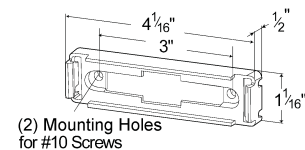

LOW PROFILE MOUNTING BRACKET FOR CLEARANCE / MARKER LAMPS

Bracket-contained plug • Legal mount for combination clearance / marker lamp when mounted on a 45° angle (PC) • Retrofits to competitors' lamps

43850 Gray

Material: Polycarbonate
Finish: Gray

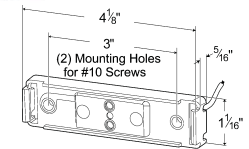

M1 SERIES LAMP BEZEL

Corrosion-resistant, chrome-plated • Sleek, aerodynamic styling • For use with 4562, 4564, 4561 and 4563 series lamp

93453 Chrome

Material: ABS
Finish: Chrome

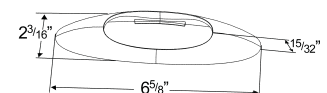

M3 SERIES LAMP BEZEL

Sleek, aerodynamic styling • Corrosion-resistant, chrome-plated • For use with 4579 and 4978 series lamps

93473 Chrome

Material: ABS
Finish: Chrome

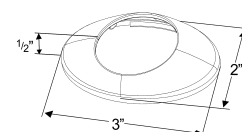

Pigtails, Brackets and Grommets

Spirales de Raccord, Bague de Montage et Supports Conectores / Soportes rígidos y flexibles

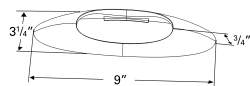

M4 SERIES LAMP BEZEL

Sleek, aerodynamic styling • Corrosion-resistant, chrome-plated • For use with 4585 lamp kit

93483 Chrome

Material: ABS
Finish: Chrome

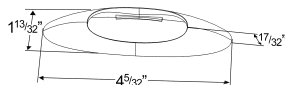

M5 SERIES LAMP BEZEL

Sleek, aerodynamic styling • Corrosion-resistant, chrome-plated • For use with 4709 LED series lamp

93713 Chrome

Material: ABS
Finish: Chrome

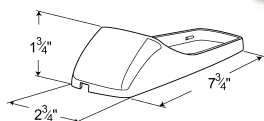

CAB MARKER BEZEL

Chrome-plated bezel • Fits 46813 and 47183 cab marker lamp (LED and Incandescent) • Can be installed while lamps are mounted

92583 Bezel

Material: ABS
Finish: Chrome

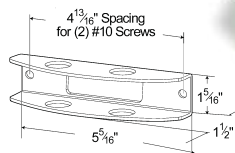

THIN-LINE LED LAMP GUARD

Separate external lamp guard • Cutaway to accept plug-in pigtail • For use with 4690 thin-line lamps

43074 Aluminum

Material: Aluminum
Finish: Aluminum

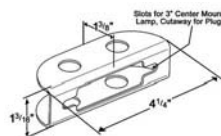

THIN-LINE 3" CENTER LAMP GUARD

Separate, external lamp guard • Cutaway to accept plug-in pigtail • Use with 4724 series lamps

43230 Aluminum

Material: Aluminum
Finish: Aluminum

LAMP GUARD FOR CLEARANCE / MARKER LAMPS

Separate external lamp guard • Cutaway to accept plug-in pigtail
 • For use with 4674-, 4709- and 4525-series lamps

43120 Aluminum

Material: Aluminum
 Finish: Polished

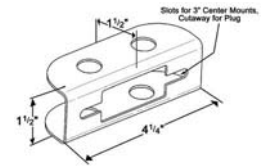

STEEL LAMP GUARD

For both lens and lamp • Fits any wiring • Fits single- and 2-bulb oval and square corner clearance / marker lamps 4678, 4679, 4543, 4670, 4671, 4526 and 4593

43144 Steel

Material: Steel
 Finish: Polished

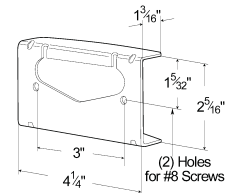

CHROME BUTTRESS-STYLE GUARD

Chrome-plated ABS • For use with 2 x 4 oval surface mounted lamps
 • Fits 4679, 4678 and 4677 marker lights

43673 Chrome
43673-5 Chrome, Retail Pack

Material: ABS
 Finish: Chrome

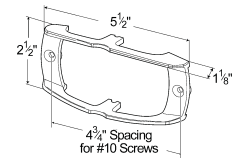

CORNER-MOUNTING BRACKET

Corner trailer mounting • Molded 9 1/2" radius base • PC-regulation mount for Turtleback® II

43030 White

Material: Polycarbonate
 Finish: White

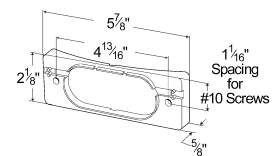

GROMMET FOR 4" ROUND LAMPS

Fits 4" round lamps • Requires 4 1/2" hole • Fits panel thickness up to 1/4"

91740 Open Grommet
91740-5 Open Grommet, Retail Pack new

KITS:
67150 Open Grommet (91740 + 67000)

Material: PVC
 Finish: Black

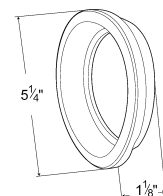

Pigtails, Brackets and Grommets

Spirales de Raccord, Bague de Montage et Supports Conectores / Soportes rígidos y flexibles

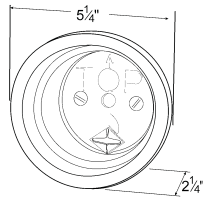

CLOSED-BACK GROMMET FOR 4" ROUND LAMPS

For open installations where splash plate is not used • Requires a 4 1/2" hole • Fits panel thickness up to 1/4"

91950 Closed Back Grommet

Material: PVC
Finish: Black

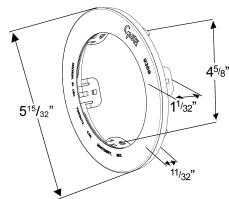

STAINLESS-STEEL SNAP-IN THEFT-RESISTANT FLANGE FOR 4" ROUND LED LAMPS

Flange is held in place by snap tabs (as opposed to standard screw holes) for a quicker, easier installation • Snap tabs on the flange lock the flange into place, keeping it from backing out of the hole • Foam gasket allows for mounting in materials from .120" to .250" thick, with a mounting hole size 4.50" diameter • No drilling to install, can help reduce installation time by more than 60%

93683 Stainless-Steel

Material: Stainless-Steel
Finish: Stainless

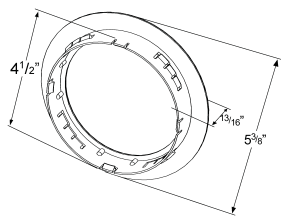

SNAP-IN THEFT-RESISTANT FLANGE FOR 4" ROUND LED LAMPS

Flange is held in place by snap tabs as opposed to standard screw holes, for a quicker, easier installation • Snap tabs on the flange lock the flange into place, keeping it from backing out of the hole • Flange is theft-resistant once snap tabs are in place • Foam gasket cushions flange from vibration and road shock • Panel thickness .120" to .250" thick mounting hole size 4.50" diameter

93550 Gray
93552 Black
93553 Chrome

Material: ABS
Finish: Black / Chrome

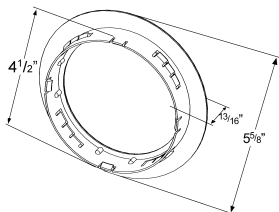

SNAP-IN THEFT-RESISTANT FLANGE FOR 4" ROUND INCANDESCENT LAMPS

Flange is held in place by snap tabs as opposed to standard screw holes, for a quicker, easier installation • Snap tabs on the flange lock the flange into place, keeping it from backing out of the hole • No drilling to install, can help reduce installation time by more than 60% • Foam gasket allows for mounting in materials from .120" to .250" thick, mounting hole size 4.50" diameter

93850 Gray **new**

Material: Polycarbonate
Finish: Gray

THEFT-RESISTANT MOUNTING FLANGE FOR 4" ROUND LAMPS

Easily snaps in place • Theft-resistant design locks lamp in place • Fits 4" round LED and incandescent lamps • Durable non-corrosive stainless-steel and polycarbonate versions • Mounting hole size 4 1/2" dia.

- 92510** White, Polycarbonate
- 92512** Black, Polycarbonate
- 92513** Chrome-Plated, ABS
- 92513-5** Chrome-Plated, ABS Retail Pack new
- 92511** Gray, Polycarbonate
- 43253** Stainless-Steel

SECURITY RING:
43343 Stainless-Steel

Material: Polycarbonate / Stainless-Steel / ABS
Finish: White; Gray; Black; Chrome; Stainless

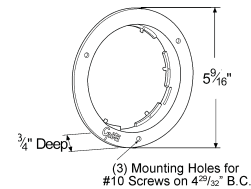
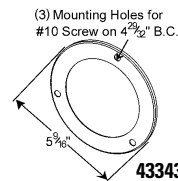

REFLECTIVE THEFT-RESISTANT FLANGE FOR 4" ROUND LAMPS

Fits 4" round S / T / T lamps • For use with LED lamps to achieve reflective requirements • Reduces materials, installation and maintenance costs by integrating the reflector into a flange

- 43702** Red

Material: Acrylic
FMVSS: A
Finish: Red

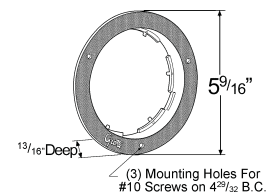

THEFT-RESISTANT BETTS* LIGHTING ADAPTER

Allows users to retrofit their Betts* brand lighting to Grote mounting dimensions • Has a built in theft resistant snap-in flange mounting • Retrofits to Grote 4" round sealed lamps and LEDs • Mounting hole size 4 1/2" diameter

- 93190** Gray

Material: Polycarbonate
Finish: Gray

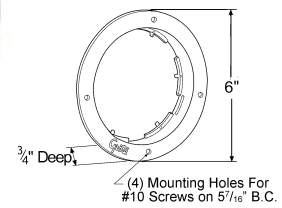

SURFACE MOUNT BRACKET FOR 4" LED LAMPS

Low-profile bracket allows for more headroom than similar surface mount incandescent lamps • Radius edges give greater bump deflection than standard surface-lamp mounting options • Surface-mount bracket is suitable for all Grote flat-backed, hard-wired 4" lamps for dome, backup, strobe and stop / tail / turn applications • Bracket accommodates hard wired lamps but can use male-pin or hard-shell connections if appropriate cutouts are made

- 94540** Gray new

Material: Polycarbonate
Finish: Gray

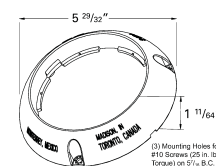

Pigtails, Brackets and Grommets

Spirales de Raccord, Bague de Montage et Supports Conectores / Soportes rígidos y flexibles

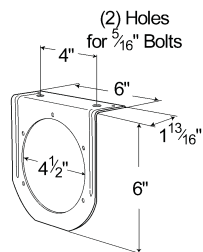

MOUNTING BRACKET FOR 4" ROUND LAMPS

Fits 4" round lamps • One 4 1/2" hole holds one standard recessed or grommet-mounted factory-sealed lamp • Use grommet 91740 for grommet-mount lamps

43572 Black

Material: Steel
Finish: Black Powder-Coated

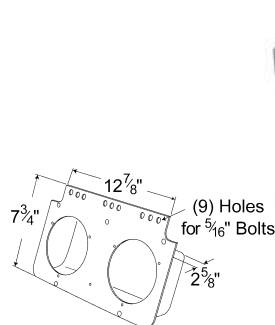

MOUNTING MODULE FOR 4" ROUND LAMPS

Closed-back rear-lamp module for lamps requiring 4-1/2" hole opening

43655 Yellow Zinc
51090 Gray

Material: Steel
Finish: Yellow Zinc / Gray Powder-Coated

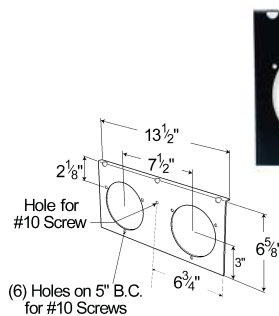

2-LAMP MOUNTING MODULE FOR 4" ROUND LAMPS

Two 4 1/2" holes to hold two standard recessed lamps or two grommet-mounted factory-sealed 4" round lamps plus one 2 1/2" center mount reflector

43642 Black, Powder-Coated

Material: Steel
Finish: Black

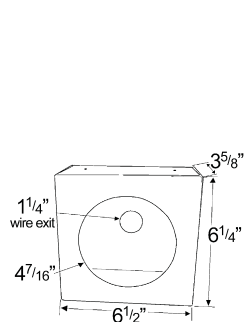

MOUNTING BOX FOR 4" ROUND LAMPS

Black enamel-coated steel construction • Use with 4" LED strobes or any 4" round lamp • Accepts lamps in grommet or theft-resistant flange mount

43732 Black

Material: Steel
Finish: Black

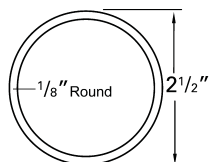

O-RING

Easy installation

94110 O-Ring for 46782, 46783 Lamps

SNAP RING FOR 4" ROUND LAMPS

Easily snaps lens to housing

- 99593** Use with 50222 and 50352
- 99595** Use with 50232 and 55092

Material: Stainless-Steel
Finish: Stainless



GROMMET FOR OVAL LAMPS

Fits oval lamps • Fits 2.5" x 6.76" oval hole • Fits panel thickness up to 1/4"

- 92420** Open Grommet
- 92420-5** Open Grommet, Retail Pack new
- 92720** Closed Back Grommet

- KITS:**
- 67151** Open Grommet (92420 + 67000)

Material: PVC
Finish: Black

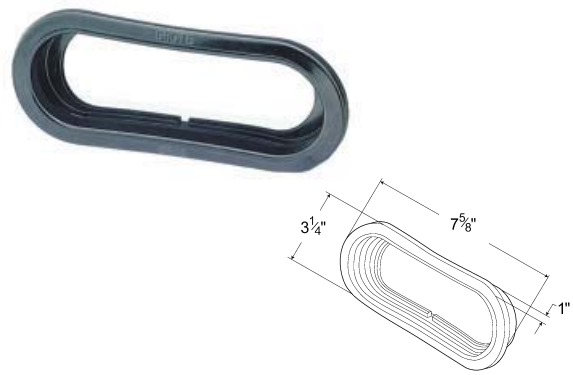

SURFACE-MOUNT OVAL LAMP ADAPTER BRACKET

Converts 7773 to grommet-mount-compatible • Fits oval lamps • Use with 92420 or 92720 grommet

- 93960** Black

Material: Polycarbonate
Finish: Black

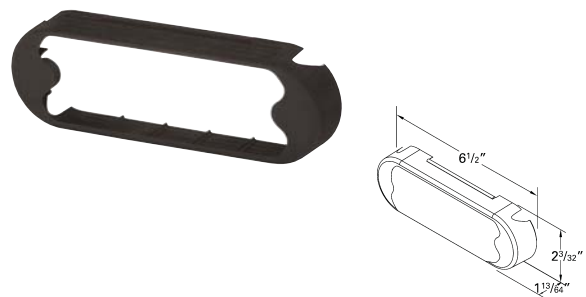

SURFACE-MOUNT SNAP-IN FLANGE FOR OVAL LAMPS

Allows for quick and easy surface-mount application • Designed to work with 5413, 5414, 5416, 5417 product lines only

- 42152** Black new
- 42153** Chrome new

Material: Polycarbonate
Finish: Black / Chrome



Pigtails, Brackets and Grommets

Spirales de Raccord, Bague de Montage et Supports Conectores / Soportes rígidos y flexibles

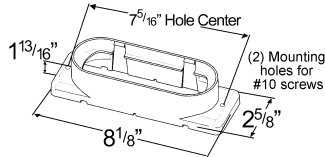

MOUNTING BRACKET FOR OVAL LAMPS

Flange incorporates rugged snap-in feature • Can be used with any Grote oval LED or incandescent lamp and many competitors' lamps • Ideal for adding LED strobe lamps to a vehicle

43172 Black

Material: Polycarbonate
Finish: Black

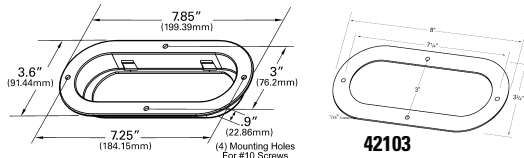

THEFT-RESISTANT MOUNTING FLANGE FOR OVAL LAMPS

Snap-in feature locks lamp in place to reduce chance of theft • Fits LED, Torsion Mount® III economy incandescent • Attractive add-on option improves the look of any rig or trailer • Security ring fits over existing oval theft resistant mounting flanges 4322 and 4372 series

- 43220** Gray, Polycarbonate
- 43222** Black, Polycarbonate
- 43223** Chrome-Plated, ABS
- 43723** Stainless-Steel

SECURITY RING:
42103 Stainless-Steel **new**

Material: Polycarbonate / Stainless-Steel / ABS
Finish: Gray / Black / Stainless / Chrome

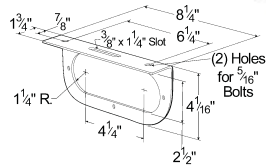

MOUNTING BRACKET FOR OVAL LAMPS

90° angle bracket • For use with oval lamps • Grommet required for mounting 92420

43362 Black

Material: Steel
Finish: Black Enamel

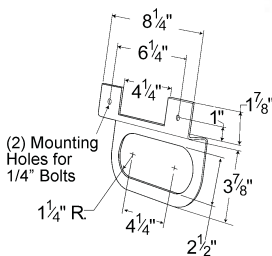

"Z" MOUNTING BRACKET FOR OVAL LAMPS

Heavy-gauge steel, baked black enamel finish • Grommet or flange required for mounting

43952 Black

Material: Steel
Finish: Black Enamel

MOUNTING BRACKET FOR OVAL LAMPS

Black enamel coated steel module • For use with 77263, LED strobes or any oval lamp

43100 Black

Material: Steel, 20 gauge
Finish: Black
Grommet: 92420

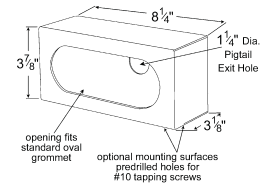

GROMMET FOR RECTANGULAR STOP / TAIL / TURN LAMPS

For use with 5220 and G450 rectangular S / T / T lamps • Requires 5 7/16" x 3 9/16" hole (with 1" radius corners) • Fits panel thickness up to 5/16"

94180 Mounting Grommet

Material: PVC
Finish: Black

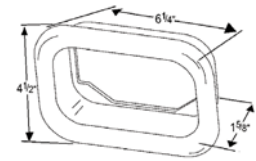

RECTANGULAR STOP / TAIL / TURN LAMP L BRACKET

Rugged 11 gauge steel construction • Black enamel coated finish • For use with 4750 and 4523 S / T / T lamps

43212 Mounting Grommet

Material: Steel
Finish: Black

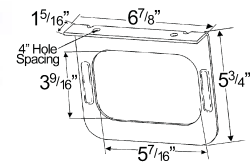

MOUNTING BRACKET FOR 7" LAMPS

Provides multiple mounting options for 7" lamps • Sturdy, rigid bracket will withstand the abuse of the daily grind

93982 Black new

Material: Steel
Finish: Black / Powder-Coated

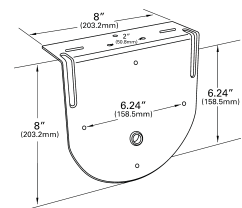

7" JUMBO MOUNTING BRACKET

Fits models 78002, 78003, 78303 and 78313 • Heavy-gauge steel, baked black enamel finish

43282 Black, Powder-Coated

Material: Steel
Finish: Black

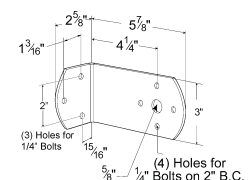

Pigtails, Brackets and Grommets

Spirales de Raccord, Bague de Montage et Supports Conectores / Soportes rígidos y flexibles

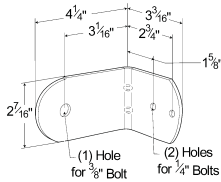

MOUNTING BRACKET

Detachable-angle mounting bracket for single- and double-face lamps

43292 Black, Powder-Coated

Material: Steel
Finish: Black

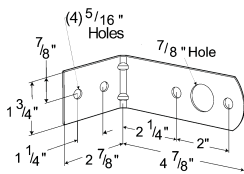

MOUNTING BRACKET

For right- or left-hand 2-stud class "A" pedestal lamps • Rigid, non-flex design

43112 Black, Powder-Coated

Material: Steel
Finish: Black



43942



43402

MOUNTING BRACKET

Can accommodate 4-pole up to 9-pole socket requirements • Made of anti-corrosive steel, painted black

43942 4, 5, and 6 pole socket bracket **new**

43402 7 and 9 pole socket bracket **new**

Material: Steel
Finish: Black



HYBRID SURFACE-MOUNT LED MID-TURN LAMP BEZEL

Fits 5349 lamps • Chrome-plated bezel resists corrosion

93773 Chrome

Material: Polycarbonate / ABS
Finish: Chrome

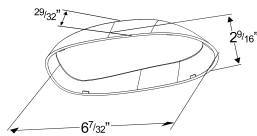

RECESSED FLUORESCENT LAMP PAN

Provides a rigid mounting surface for fluorescent lamps • Fits Grote's fluorescent lamp 61511 • Keeps insulation away from lamp

43540 Recessed Pan

Material: Aluminum
Finish: Polished

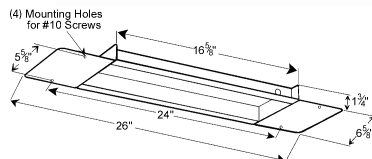

12" RECESSED MOUNTING PAN FOR 7" LED LAMPS

Provides a rigid mounting surface for LED lamps • Fits Grote® LED 61811 lamps • Grommet available for wire exit hole, 60-1000-06 • Keeps insulation away from lamp

43744 Recessed Pan **new**

Material: Aluminum
Finish: Aluminum

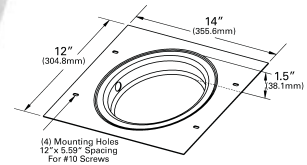

SLOW-MOVING VEHICLE EMBLEM BRACKET AND MOUNTING BRACKET

Easy installation • Use with slow moving vehicle emblem (71152); emblem itself is not included with this bracket not included

EMBLEM BRACKET:

43325 Steel

MOUNTING BRACKET:

43335 Steel

Material: Steel
Finish: Galvanized



43325



43335

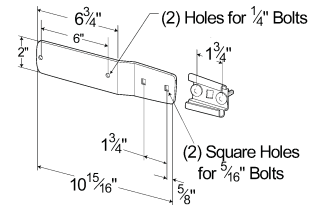

SELF-LEVELING BRACKET

Fits 7622, 7628 and 7633 series Roto-Beacons • Often used for dump-truck beds

76121 Black, Powder-Coated

Material: Steel
Finish: Black

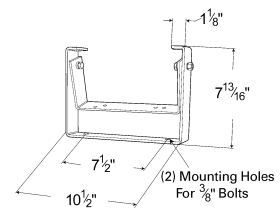

Pigtails, Brackets and Grommets

Spirales de Raccord, Bague de Montage et Supports Conectores / Soportes rígidos y flexibles



93602
93603

93602

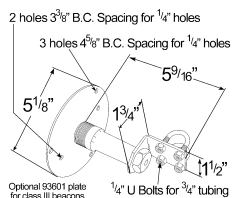

93601

STROBE AND BEACON MOUNTING BRACKETS FOR MIRROR BRACKETRY

93601 plate adapter for use with products that do not have a 1" pipe mount built-in (7604, 7710, 7701 style) • 93602 is 1/2" pipe adapter that changes 1" pipe mount to 1/2" for competitive strobes

93601 Mounting Plate Adapter

PIPE MOUNT:

93600 Bracket w / 1" Built-in Mount

93602 1"-1/2" Adapter

93603 1/2" Pipe Mount

Material: Aluminum / Steel / Brass
Finish: Gray / Stainless



STROBE MOUNTING KIT

For use with low, medium, and high profile strobe lamps • Has an adhesive magnet pad to prevent scratching of vehicle surface

97750 Magnet Kit and Lighter Plug

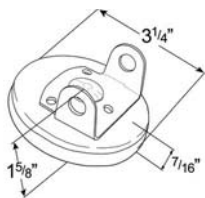

REPLACEMENT MAGNETIC MOUNT

Replacement magnetic mount for towing lamp kits • Can be used as a magnetic mount on PAR 36-rubber tractor and utility lamps • Has adhesive magnet pad to prevent scratching of vehicle metal underneath magnet
• 80-lbs pull magnet

MOUNTING HARDWARE:

43300 Magnetic Mount

Material: Steel
Finish: Chrome

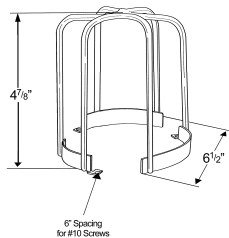

BRANCH GUARD

For use with low-, medium- and high-profile strobe lamps

FITS LOW PROFILE LAMPS:

43910 Black

FITS MEDIUM PROFILE LAMPS:

43550 Black

FITS HIGH PROFILE LAMPS:

99490 Black

Material: Steel
Finish: Black Enamel

HEAVY-DUTY ROOF BAR

62" length with 4" adjustments • Low-profile design minimizes wind resistance • Permanent installation for all vehicle types • Fits any roof contour • Constructed of 2 1/2" aluminum material • For use with 76903 bar lamp

43494 62" Bar

Material: Aluminum
Finish: Aluminum

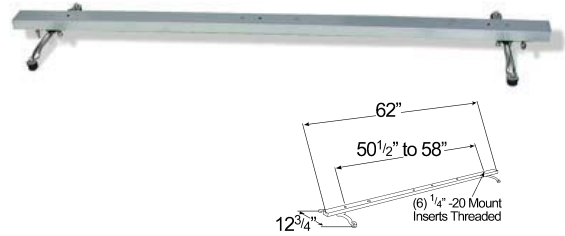

UNIVERSAL TWO-STUD LICENSE BRACKET

Fits 5053-, 5054-, 5085-, 5086-, 5088-, 5089-, 5094-, 5263-, 5371-, 5290-, 5291-, 5090-, 5091-, 5376-, 5099-, 5297- and 5372-series lamps

43262-5 Black, Retail Pack

Material: DURAMOLD®
Finish: Black



UNIVERSAL TWO-STUD NON-OFFSET MOUNTING BRACKET

Replacement for trailer kits 65312 and 65330-5 • Fits 5382 and 5249 lamps

93212 Black

Material: DURAMOLD®
Finish: Black

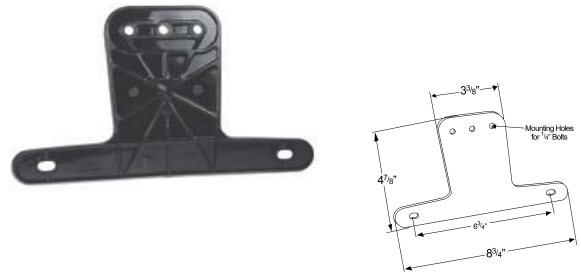

LICENSE BRACKET

2-stud license plate bracket • Fits 52972

43022 Black, Powder-Coated
43022-5 Black, Powder-Coated, Retail Pack

Material: Steel
Finish: Black

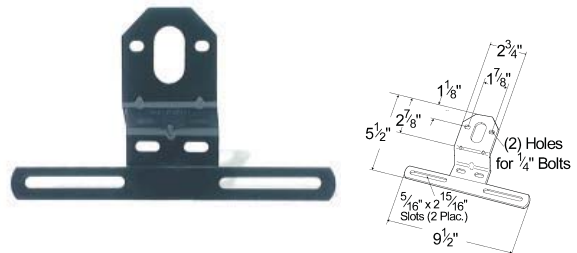

LICENSE BRACKET

For use with 5090-, 5091-, 5094-, 5095-, 5097-, 5099-, 5280-, 5281-, 5282-, 5283-, 5290-, 5291-, 5297-, 5260-, 5370-, 5371-, 5372- and 5376-series lamps

43272 Black, Powder-Coated
43272-5 Black, Powder-Coated, Retail Pack

Material: Steel
Finish: Black

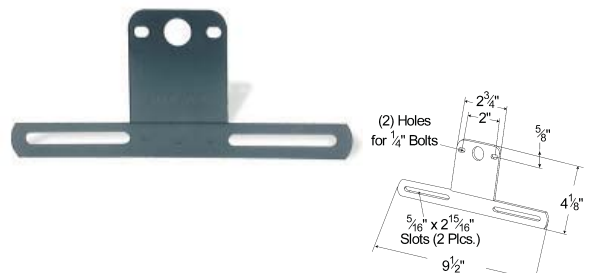

LICENSE BRACKET

For use with 5090-, 5091-, 5094-, 5095-, 5097-, 5280-, 5281-, 5282- and 5283-series lamps • Black enamel finish

43842 Black, Powder-Coated

Material: Steel
Finish: Black

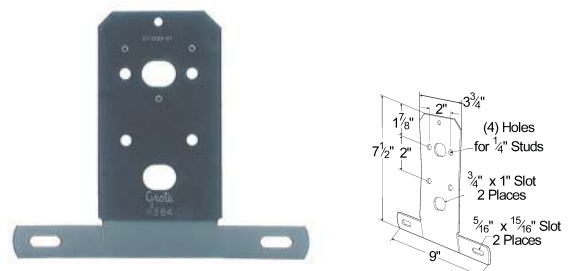

Pigtails, Brackets and Grommets

Spirales de Raccord, Bague de Montage et Supports Conectores / Soportes rígidos y flexibles

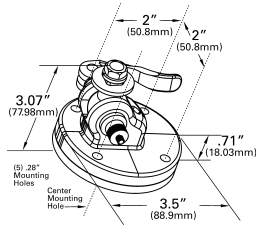

ADJUSTABLE BRACKET FOR TRILLIANT®

Adjustable and lockable bracket for the Trilliant® LED Whitelight® lamps

- More aiming control and more reliable than the standard bracket
- Cantilever locking mechanism stays in place in even the harshest environments

43652 Adjustable Bracket **new**

Material: Zinc
Finish: Black

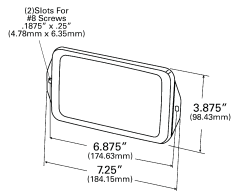

FLUSH-MOUNT WORK-LAMP BRACKET

Add-on bracket to make the Trilliant® Mini LED WhiteLight™ a flush-mount lamp

94690 Bracket **new**

Material: Stainless-Steel
Finish: Stainless

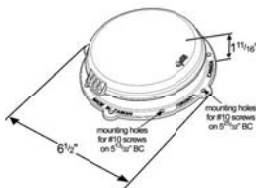

DOCUMENT HOLDER

Rugged construction • Chemical-resistant, Ray-Ban® colored lens now has a darker tint • Comes with document protector poly bag • Two mounting options for flexibility • Can be installed using pop-rivets

43901 Gray

Material: Polycarbonate
Finish: Gray / Smoke
Lens: Smoke 93351

Pigtails, Brackets and Grommets

Spirales de Raccord, Bague de Montage et Supports Conectores / Soportes rígidos y flexibles

211

PIGTAILS, BRACKETS AND GROMMETS

ALUMINUM PERMIT HOLDER

Heavy-formed, rustproof housing • Includes vinyl pouch

43424 Aluminum

Material: Aluminum w / Vinyl pouch
Accessory: Vinyl Pouch: 43441

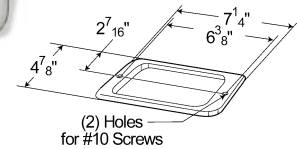

VINYL PERMIT HOLDER

Laminated for all-weather protection • Sealing zipper for easy insertion of paper

43411 Vinyl

Material: Vinyl / Aluminum
Finish: Green / Aluminum

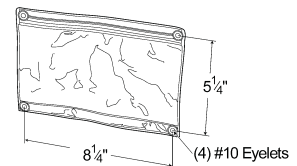

ELECTRICAL SEALANT

Special dielectric silicone compound seals out moisture, salt and corrosives; protects plug-ins and other electrical fittings

99580 1.25 Ounce Tube



ULTRA-SEAL CORROSION PREVENTIVE SEALANT

Cost-effective product prevents rust and corrosion • Good mechanical stability • Added tackifiers improve adhesion and resistance to washout

- Has a 25% higher non-conductivity rating compared to the competition
- Operating range -40°F to 302°F

99170 4 oz. (118 ml) Tube
99180 8 oz. (236 ml) Tub

RETAIL DISPLAY:

99170-1 Display (12 of 99170) Retail Pack



grote.com

211

Reflectors

Réfecteurs Reflectantes

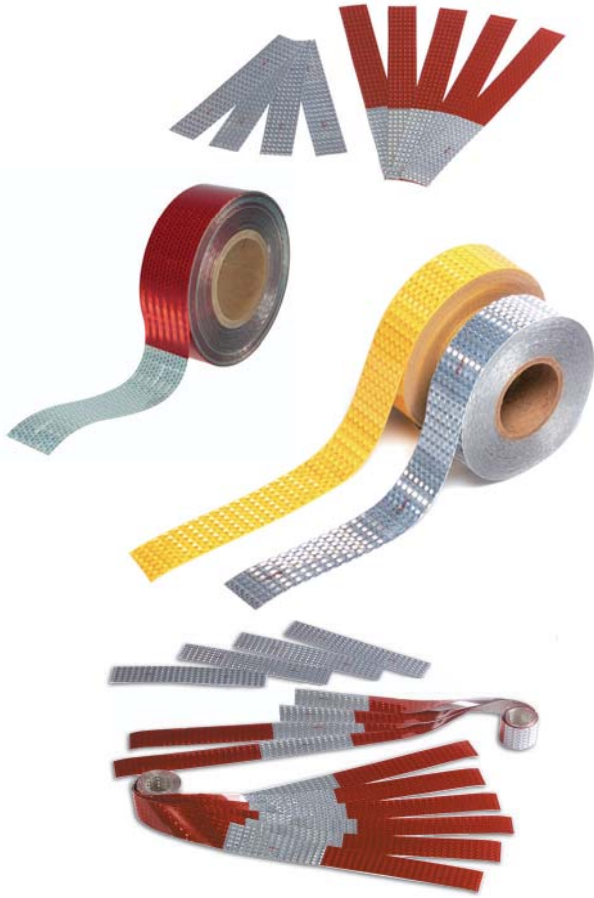

CONSPICUITY TAPE

Exceeds DOT requirements • Durable, impact and solvent resistant • Easy installation • Reflects light even in daytime • Bright prismatic appearance

ALTERNATING 7" SILVER / 11" RED:

- 40650** 2" x 150' Roll
- 40650-5** 2" x 18" (5) Strips, Poly Bag, Retail Kit
- 41160** 2" x 150' Roll
- 41080** 1 1/2" x 150' Roll
- 40980** 53-Ft. Trailer Kit: (4) 2" x 90" Red / Silver Strips, (4) 2" x 72" Red / Silver Strips, (2) 2" x 101" Red / Silver Strips, (4) 2" x 12" Silver Strips, Instruction Sheet, Retail Kit

ALTERNATING 6" SILVER / 6" RED:

- 41050** 2" x 150' Roll
- 41070** 1 1/2" x 150' Roll

SILVER:

- 40641** 2" x 150' Roll
- 40641-5** 2" x 12" (4) Strips, Poly Bag

WHITE:

- 40701** 1" x 150' Roll

SCHOOL BUS APPLICATIONS:

- 41133** Yellow, 2" x 150' Roll

FMVSS: DOT-C2

CONSPICUITY TAPE FOR RAIL CARS

Adhesive will adhere to cold surfaces • Reflects light even in daytime • Bright prismatic appearance

4" X 150' ROLL:

- 41271** White
- 41273** Yellow, Kiss-Cut

FRA-224



REFLECTIVE STRIPS

Sealed optics • Adhesive-backed and screw-on versions • Easily mountable on truck or trailer

12" STRIPS:

- 41121** Silver
- 41122** Red

Material: ABS / Acrylic
FMVSS: DOT-C

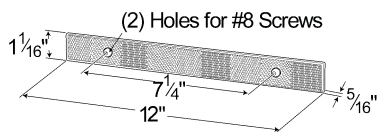

STICK-ON TAPE REFLECTORS

Adheres permanently to flat or curved surfaces • Exceeds DOT and SAE reflex requirements • Durable, impact-resistant

1 11/16" X 4 1/4" RECTANGULAR REFLECTOR:

- 41152** Red
- 41152-5** Red, Pair Pack, Retail Pack
- 41153** Yellow
- 41153-5** Yellow, Pair Pack, Retail Pack

2 15/16" ROUND REFLECTOR:

- 41142** Red
- 41142-5** Red, Pair Pack, Retail Pack
- 41143** Yellow
- 41143-5** Yellow, Pair Pack, Retail Pack

FMVSS: A

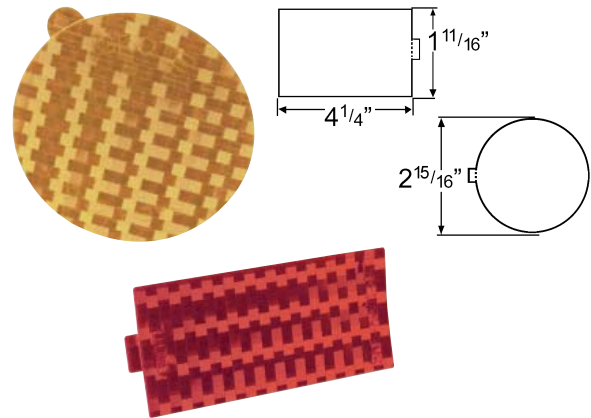

REFLECTIVE TAPE

Use in marking fence posts, mail boxes, etc. • 2" x 24" strips • Not for use as trailer conspicuity tape

- 40440-5** Red w / White, 1 Strip, Retail Pack
- 40460-5** Black w / Yellow, 1 Strip, Retail Pack

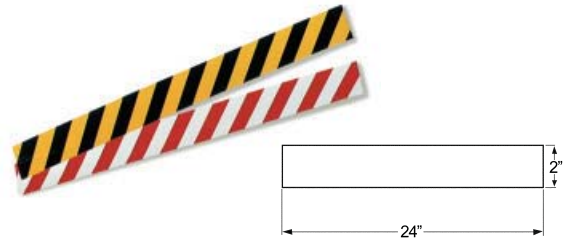

3 1/4" X 1 1/2" RECTANGULAR REFLECTORS

• Adhesive backing protects prism against dirt • Fits narrow rails and tight spaces • Firm-stick backing for instant bond and lasting adhesion

- 40302** Red
- 40303** Yellow

Material: Acrylic
FMVSS: A

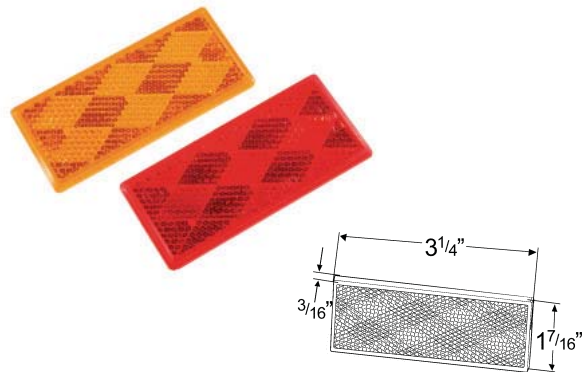

MINI STICK-ON RECTANGULAR REFLECTOR

Fits narrow rails and tight spaces • Mountable with two #8 screws (optional) • Firm-stick backing for instant bond and lasting adhesion

STICK-ON / SCREW MOUNTABLE:

- 40132** Red
- 40132-5** Red, Pair Pack, Retail Pack
- 40133** Yellow
- 40133-5** Yellow, Pair Pack, Retail Pack

Material: Acrylic
FMVSS: A

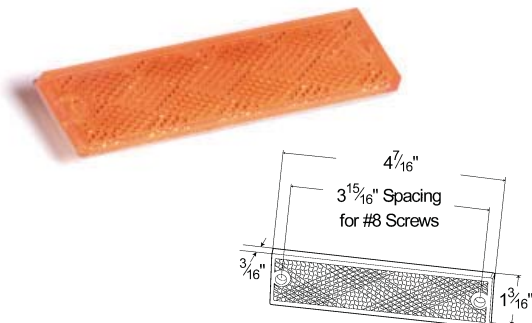

Reflectors

Réflecteurs Reflectantes

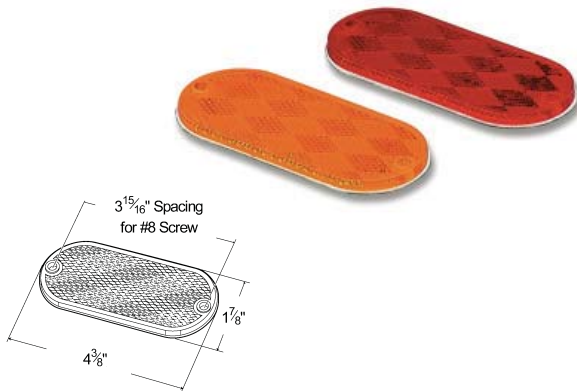

OVAL REFLECTOR

Fits in narrow channels

SCREW MOUNTABLE:

41042 Red
41043 Yellow

STICK-ON / SCREW MOUNTABLE:

41032 Red
41032-5 Red, Pair Pack, Retail Pack
41033 Yellow
41033-5 Yellow, Pair Pack, Retail Pack

Material: Acrylic
FMVSS: A

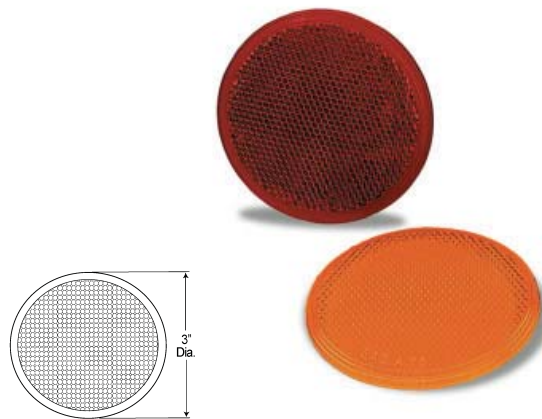

ROUND STICK-ON REFLECTOR

Adhesive backing protects prism against dirt • Firm-stick backing for instant bond and lasting adhesion

3" REFLECTOR:

40052 Red
40052-5 Red, Retail Pack
40053 Yellow
40053-5 Yellow, Retail Pack

2" REFLECTOR:

41002 Red
41003 Yellow

Material: Acrylic
FMVSS: A

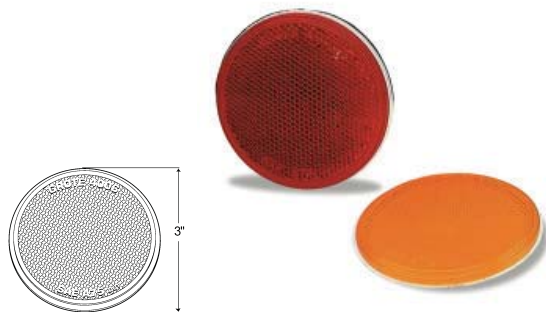

SEALED 3" ROUND STICK-ON REFLECTOR

Hermetically sealed • Firm-stick backing for instant bond and lasting adhesion

40062 Red
40063 Yellow

Material: Acrylic
FMVSS: A

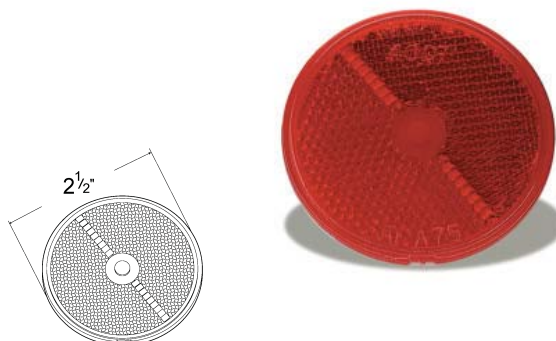

2 1/2" ROUND STICK-ON REFLECTOR

Adhesive backing protects prism against dirt • Fits small areas
• Firm-stick backing for instant bond and lasting adhesion

40072 Red
40072-5 Red, Pair Pack, Retail Pack
40073 Yellow
40073-5 Yellow, Pair Pack, Retail Pack

Material: Acrylic
FMVSS: A

SEALED CENTER-MOUNT REFLECTOR

Hermetically sealed • Simple installation with single #10 screw

2" ROUND:

- 41012** Red
- 41013** Yellow

2 1/2" ROUND:

- 40092** Red
- 40093** Yellow

3 1/2" ROUND:

- 40152** Red
- 40153** Yellow

Material: Acrylic
FMVSS: A

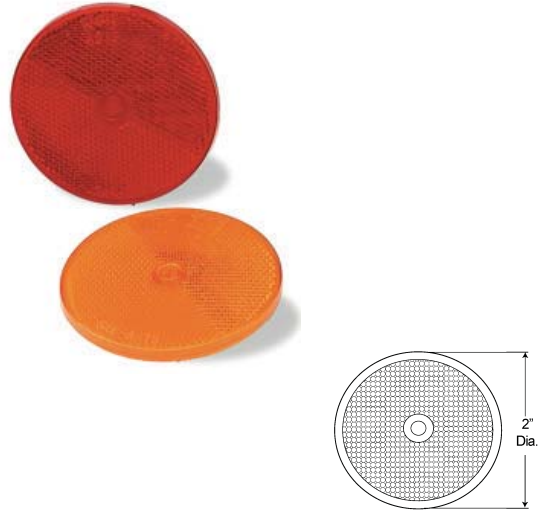

ALUMINUM 3" LENS TWO-HOLE MOUNTING REFLECTOR

Lens gasket cushions lens and protects prisms against dirt • Lightweight housing • Low profile

- 40232** Red
- 40232-5** Red, Retail Pack
- 40233** Yellow
- 40233-5** Yellow, Retail Pack

Material: Aluminum / Acrylic
FMVSS: A

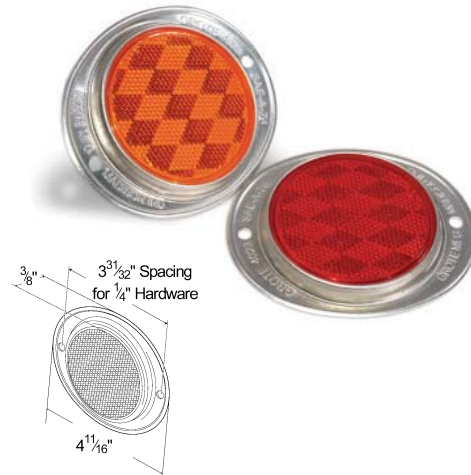

STEEL 3" LENS TWO-HOLE MOUNTING REFLECTOR

Extra-deep lens recessed for protection • Lens gasket cushions lens and protects prisms against dirt • Baked steel finish

- 40192** Red
- 40193** Yellow
- 82552** Red, Green Housing new
- 82553** Yellow, Green Housing new
- 82562** Red, Tan Housing new
- 82563** Yellow, Tan Housing new

Material: Steel / Acrylic
FMVSS: A
Finish: Gray, Military Green 34094, Desert Tan 33446



Reflectors

Réfecteurs Reflectantes

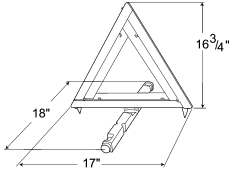

TRIANGLE WARNING KIT

Reflective up to 1/2 mile • Exceeds legal requirements • Weatherproof and impact-resistant • Weighted for stability • Kit of three triangle devices in carrying case

KITS:

71422 Three Triangles

Material: DURAMOLD®
FMVSS: 125, SAE: J774c-Type I

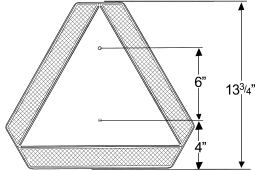

SLOW-MOVING VEHICLE EMBLEM

13 3/4" yellow-orange center for daytime warning • Outer 1 5/8" red reflex border for nighttime warning

71152 Orange and Red

Material: DURAMOLD®
SAE: J943a, ASAE: S276.3



TRAFFIC CONE

High visibility for traffic control • Fade-resistant, bright orange finish is molded of PVC to eliminate cracking and peeling

71440 Small Cone
71450 Large Cone

Material: PVC
Finish: Bright Orange

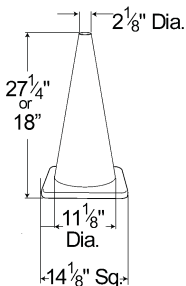

REPLACEMENT LENSES

		S / T / T		Front Park and Turn		Rear Side		Front Side	
		Left	Right	Left	Right	Left	Right	Left	Right
Cadillac*									
2001-2000	Escalade	85662-5	85672-5						
2000-1999	Escalade (Lens and Housing)	85352-5	85362-5						
2000-1999	Escalade (Early Design, Single HL)							86043°	86053°
Chevrolet*									
2002-1988	1500, 2500, 3500 Pickup (Early Design, Single HL)			86141°	86151°				
2001-1988	1500, 2500, 3500 Pickup (Without Trim, Sgl HL)							86043°	86053°
2000-1999	1500, 2500, 3500 Pickup	85642-5	85652-5						
1999-1988	1500, 2500, 3500 Pickup (Lens and Housing)	85352-5	85362-5						
1999-1988	1500, 2500, 3500 Pickup (Connector Plate Housing)	85450-5	85460-5						
1993-1988	1500, 2500, 3500 Pickup (Grey Trim, Dual HL)			86161°	86171°				
1993-1988	1500, 2500, 3500 Pickup (Lamp, Dual HL)							86063°	86073°
1993-1988	1500, 2500, 3500 Pickup (Reflector, Dual HL)							86083°	86093°
1991-1981	1500, 2500, 3500 Pickup (Chrome Trim)							85033-5	85043-5
1991-1981	1500, 2500, 3500 Pickup (No Chrome Trim)							86013°	86023°
1991-1973	1500, 2500, 3500 Pickup (Lens w / o Chrome Trim)	85232-5	85242-5						
1991-1973	1500, 2500, 3500 Pickup (Lens w / Chrome Trim)	85252-5	85262-5						
1991-1973	1500, 2500, 3500 Pickup (Housing Only)	86180°	86190°						
1991-1973	1500, 2500, 3500 Pickup (w / o Trim on Lens, w / Housing)	86492°	86502°						
1991-1973	1500, 2500, 3500 Pickup (Chrome Trim Lens, w / Housing)	86512°	86522°						
1989-1988	1500, 2500, 3500 Pickup (Black Trim, Dual HL)			86121°	86131°				
1980-1973	1500, 2500, 3500 Pickup (Chrome Trim)							85053-5	85053-5
1980-1973	1500, 2500, 3500 Pickup (No Chrome Trim)							85063-5	85063-5
1978-1973	1500, 2500, 3500 Pickup (Chrome Trim)					85052°	85052°		
1978-1973	1500, 2500, 3500 Pickup (No Chrome Trim)					85062°	85062°		
1972-1968	1500, 2500, 3500 Pickup					85972°	85972°	85973°	85973°
1972-1967	1500, 2500, 3500 Pickup	85552-5	85552-5						
1970-1965	4000 Tilt Cab			86573°	86573°				
Blazer									
2004-2002	Blazer	86552°	86562°						
2001-1995	Blazer	85682-5	85692-5						
2000-1992	Blazer (Lens and Housing)	85352-5	85362-5						
2000-1992	Blazer (Connector Plate Housing)	85450-5	85460-5						
1994-1992	Blazer (w / o Trim, Sgl HL)			86141°	86151°				
1994-1992	Blazer (Early Design, Single HL)							86043°	86053°
1993-1992	Blazer (Grey Trim, Dual HL)			86161°	86171°				
1993-1992	Blazer (Dual Headlamps)							86063°	86073°
1993-1992	Blazer (Reflector, Dual HL)							86083°	86093°
1993-1992	Blazer (Frt Lamp and Reflector, Dual HL)							86103°	86113°
1991-1981	Blazer (Chrome Trim)							85033-5	85043-5
1991-1981	Blazer (No Chrome Trim)							86013°	86023°
1991-1973	Blazer (Lens w / o Chrome Trim)	85232-5	85242-5						
1991-1973	Blazer (Lens w / Chrome Trim)	85252-5	85262-5						
1991-1973	Blazer (Housing Only)	86180°	86190°						
1991-1973	Blazer (w / o Trim on Lens, w / Housing)	86492°	86502°						
1991-1973	Blazer (Chrome Trim Lens, w / Housing)	86512°	86522°						
1980-1973	Blazer (Chrome Trim)							85053-5	85053-5
1980-1973	Blazer (No Chrome Trim)							85063-5	85063-5
Fleetside Pickup									
2000-1999	Fleetside Pickup	85642-5	85652-5						
1972-1967	Fleetside Pickup	85552-5	85552-5						
S-10 Blazer									
2001-1995	S-10 Blazer	85682-5	85692-5						
1994-1983	S-10 Blazer (w / o Trim)	85072-5	85082-5						
1994-1983	S-10 Blazer (Chrome Trim)	85172-5°	85182-5°						
1994-1983	S-10 Blazer (Black Trim)	85952°	85962°						
S-10 Pickup									
2003-1994	S-10 Pickup	85532-5	85542-5						
1994-1983	S-10 Pickup							85093-5	85103-5
1993-1983	S-10 Pickup			85313-5	85323-5				
1993-1982	S-10 Pickup (w / o Trim)	85072-5	85082-5						
1993-1982	S-10 Pickup (Chrome Trim)	85172-5	85182-5						
1993-1982	S-10 Pickup (Black Trim)	85952°	85962°						
Silverado									
2004-2003	Silverado	86532°	86542°						
2002-1999	Silverado	85642-5	85652-5						
Van									
1996-1985	Van	86202°	86212°					85983°	85983°
1993-1985	Van					85982°	85982°		
1987-1968	Van (Red)					85972°	85972°		
1987-1968	Van (Amber)							85973°	85973°

° = **new**

Lenses

Lentilles Micas

Chevrolet* Cont.

		S/T/T		Front Park and Turn		Rear Side		Front Side	
		Left	Right	Left	Right	Left	Right	Left	Right
Chevrolet*									
/GMC*									
2002-2000	Suburban	85662-5	85672-5						
1999-1992	Suburban (Lens and Housing)	85352-5	85362-5						
1999-1992	Suburban (w/o Trim, Sgl HL)			86141°	86151°				
1999-1992	Suburban (Early Design, Single HL)							86043°	86053°
1999-1992	Suburban (Connector Plate Housing)	85450-5	85460-5						
1993-1992	Suburban (Grey Trim, Dual HL)			86161°	86171°				
1993-1992	Suburban (Dual Headlamps)							86063°	86073°
1993-1992	Suburban (Lamp and Reflector, Dual HL)							86103°	86113°
1991-1981	Suburban (Chrome Trim)							85033-5	85043-5
1991-1981	Suburban (No Chrome Trim)							86013°	86023°
1991-1973	Suburban (Lens w/o Chrome Trim)	85232-5	85242-5						
1991-1973	Suburban (Lens w/o Chrome Trim)	85252-5	85262-5						
1991-1973	Suburban (Housing Only)	86180°	86190°						
1991-1973	Suburban (w/o Trim on Lens, w/Housing)	86492°	86502°						
1991-1973	Suburban (Chrome Trim Lens, w/Housing)	86512°	86522°						
1980-1973	Suburban (Chrome Trim)					85052°	85052°	85053-5	85053-5
1980-1973	Suburban (No Chrome Trim)					85062°	85062°	85063-5	85063-5
Chrysler*									
2004-2001	Town and Country	86432°	86442°						
2000-1996	Town and Country	85602-5	85612-5						
1995-1991	Town and Country	85472-5	85482-5						
1990-1984	Town and Country	85342-5	85332-5						
Dodge*									
2005-2005	Caravan	86472°	86482°						
2004-2001	Caravan	86432°	86442°						
2000-1996	Caravan	85602-5	85612-5						
1990-1984	Caravan	85342-5	85332-5						
2006-2005	Dakota	86452°	86462°						
2002-1997	Dakota	85782-5	85792-5						
1996-1987	Dakota (w/o Trim)	85392-5	85402-5						
1996-1987	Dakota (Chrome Trim)	85412-5	85422-5						
1996-1987	Dakota (Chrome Across Lens)	86302°	86312°						
1996-1987	Dakota (Chrome Trim and across Lens)	86322°	86332°						
2002-1998	Durango	85602-5	85612-5						
2005-2002	Ramcharger Pickup	86412°	86422°						
2001-1994	Ramcharger Pickup	85582-5	85592-5						
1993-1978	Ramcharger Pickup (Chrome Trim)	85432-5	85442-5						
1993-1978	Ramcharger Pickup (Black Trim)	86262°	86272°						
1993-1978	Ramcharger Pickup (Black Chrome Trim across lens)	86282°	86292°						
1993-1978	Ramcharger Pickup (Chrome Trim and across Lens)	86342°	86352°						
1977-1972	Ramcharger Pickup	85202-5	85192-5						
2005-2002	Trail Duster Pickup	86412°	86422°						
2001-1994	Trail Duster Pickup	85582-5	85592-5						
1993-1978	Trail Duster Pickup (Chrome Trim)	85432-5	85442-5						
1993-1978	Trail Duster Pickup (Black Trim)	86262°	86272°						
1993-1978	Trail Duster Pickup (Black Chrome Trim across Lens)	86282°	86292°						
1993-1978	Trail Duster Pickup (Chrome Trim and across Lens)	86342°	86352°						
1977-1972	Trail Duster Pickup (Chrome Trim)	85202-5	85192-5						
1993-1978	Van	85212-5	85222-5						
1977-1970	Van	86752°	86752°						
Ford*									
1996-1992	Bronco (Headlamps)			86221°	86231°				
1986-1980	Bronco	85132-5	85142-5					85013-5	85023-5
1986-1980	Bronco (Clear)			85941°	85941°				
1986-1980	Bronco (Yellow)			85943°	85943°				
1979-1978	Bronco	85152-5	85162-5			85002-5	85002-5	85003-5	85003-5
1977-1967	Bronco	86252°	86242°						
1977-1966	Bronco			86002°	86002°	86003°	86003°		
1991-1987	Bronco II	85292-5°	85302-5°						
1990-1989	Bronco II			86603°	86613°			86703°	86713°
1988-1983	Bronco II			86583°	86593°			85273-5	85283-5

° = new

Ford* Cont.		S/T/T		Front Park and Turn		Rear Side		Front Side	
		Left	Right	Left	Right	Left	Right	Left	Right
2003-1995	Econoline	85512-5	85522-5						
1994-1992	Econoline	85493-5°	85503-5°						
1991-1975	Econoline	85152-5	85162-5			85002-5	85002-5	85003-5	85003-5
1974-1973	Econoline					86002°	86002°	86003°	86003°
1974-1967	Econoline	86252°	86242°						
2006-2001	Escape	86680°	86690°						
2003-2000	Excursion	85512-5	85522-5						
2005-2002	Explorer	86660°	86670°						
2001-1998	Explorer	85742-5	85752-5						
1997-1995	Explorer	85722-5	85732-5						
1994-1991	Explorer	85372-5	85382-5	86603°	86613°			86703°	86713°
1992-	Ford F350-F750, Super Duty (Entire Lamp)	50992	50992						
1990-1977	Flareside Pickup (Lens Only)	91302	91302						
1990-1977	Flareside Pickup (LED-Entire Lamp)	G5212°	G5202°						
1979-1973	Flareside Pickup					86002°	86002°		
1979-1973	Flareside Pickup (Entire Lamp)	50972-5	50972-5						
2001-1998	Mountaineer	85742-5	85752-5						
1997-1995	Mountaineer	85722-5	85732-5						
2003-1997	Pickup	85622-5	85632-5						
1996-1992	Pickup	85562-5	85572-5						
1996-1992	Pickup (Headlamps)			86221°	86231°				
1991-1987	Pickup	85292-5°	85302-5°						
1986-1980	Pickup	85132-5	85142-5					85013-5	85023-5
1986-1980	Pickup (Clear)			85941°	85941°				
1986-1980	Pickup (Yellow)			85943°	85943°				
1979-1978	Pickup	85152-5	85162-5						
1979-1973	Pickup					85002-5	85002-5	85003-5	85003-5
1972-1967	Pickup	86252°	86242°						
2005-2001	Ranger	86642°	86652°						
2000-2000	Ranger	86622°	86632°						
1999-1998	Ranger	85802-5	85812-5						
1997-1993	Ranger	85702-5	85712-5	85762-5	85772-5				
1992-1989	Ranger			86603°	86613°			86703°	86713°
1992-1983	Ranger	85112-5	85122-5						
1988-1983	Ranger			86583°	86593°			85273-5	85283-5
GMC* / Chevrolet*									
2006-2002	Envoy	86762°	86772°						
2003-1997	Envoy	85682-5	85692-5						
2001-1995	Jimmy	85682-5	85692-5						
1994-1983	Jimmy			85313-5	85323-5			85093-5	85103-5
1991-1981	Jimmy (Chrome Trim)							85033-5	85043-5
1991-1981	Jimmy (No Chrome Trim)							86013°	86023°
1991-1973	Jimmy (Lens w / o Chrome Trim)	85232-5	85242-5						
1991-1973	Jimmy (Lens - w / Chrome Trim)	85252-5	85262-5						
1991-1973	Jimmy (Housing Only)	86180°	86190°						
1991-1973	Jimmy (w / o Trim on Lens, w / Housing)	86492°	86502°						
1991-1973	Jimmy (Chrome Trim Lens, w / Housing)	86512°	86522°						
1980-1973	Jimmy (Chrome Trim)					85052°	85052°	85053-5	85053-5
1980-1973	Jimmy (No Chrome Trim)					85062°	85062°	85063-5	85063-5
1972-1970	Jimmy	85552-5	85552-5						
2000-1999	Pickup	85642-5	85652-5						
2000-1988	Pickup (Lens and Housing)	85352-5	85362-5						
2000-1988	Pickup (w/o Trim, Sgl HL)			86141°	86151°				
2000-1988	Pickup (Reflector, Sgl HL)							86043°	86053°
2000-1988	Pickup (Connector Plate Housing)	85450-5	85460-5						
1993-1988	Pickup (Grey Trim, Dual HL)			86161°	86171°				
1993-1988	Pickup (Lamp and Reflector, Dual HL)	86103°	86113°						
1991-1981	Pickup (Chrome Trim)							85033-5	85043-5
1991-1981	Pickup (w/o Chrome Trim)							86013°	86023°
1991-1973	Pickup (Lens w / o Chrome Trim)	85232-5	85242-5						
1991-1973	Pickup (Lens - w / Chrome Trim)	85252-5	85262-5						

° = new

Lenses

Lentilles Micas

GMC*		S/T/T		Front Park and Turn		Rear Side		Front Side	
		Left	Right	Left	Right	Left	Right	Left	Right
1991-1973	Pickup (Housing Only)	86180°	86190°						
1991-1973	Pickup (w / o Trim on Lens, w / Housing)	86492°	86502°						
1991-1973	Pickup (Chrome Trim Lens, w / Housing)	86512°	86522°						
1989-1988	Pickup (Reflector, Dual HL)							86083°	86093°
1980-1973	Pickup (Chrome Trim)					85052°	85052°	85053-5	85053-5
1980-1973	Pickup (No Chrome Trim)					85062°	85062°	85063-5	85063-5
1972-1968	Pickup					85972°	85972°	85973°	85973°
1970-1967	Pickup	85552-5	85552-5						
2001-1995	S-15 Jimmy	85682-5	85692-5						
1994-1983	S-15 Jimmy			85313-5	85323-5			85093-5	85103-5
1994-1983	S-15 Jimmy (w / o Trim)	85072-5	85082-5						
1994-1983	S-15 Jimmy (Chrome Trim)	85172-5	85182-5						
1994-1983	S-15 Jimmy (Black Trim)	85952°	85962°						
1994-1983	S-15 Pickup							85093-5	85103-5
1994-1983	S-15 Pickup (w / o Trim)	85072-5	85082-5					85093-5	85103-5
1994-1983	S-15 Pickup (Chrome Trim)	85172-5	85182-5						
1994-1983	S-15 Pickup (Black Trim)	85952°	85962°						
1993-1983	S-15 Pickup			85313-5	85323-5				
2004-2003	Sierra	86532°	86542°						
2000-1999	Sierra	85642-5	85652-5						
2000-1988	Sierra (w / o Trim, Sgl HL)			86141°	86151°				
1993-1990	Sierra (Grey Trim, Dual HL)			86161°	86171°				
1993-1988	Sierra (Dual Headlamps)							86063°	86073°
2003-1994	Sonoma	85532-5	85542-5						
1993-1983	Sonoma (w / o Trim)	85072-5	85082-5						
1993-1983	Sonoma (Chrome Trim)	85172-5	85182-5						
1993-1983	Sonoma (Black Trim)	85952°	85962°						
1993-1982	Sonoma			85313-5	85323-5			85093-5	85103-5
1996-1985	Van	86202°	86212°			85982°	85982°	85983°	85983°
1987-1968	Van					85972°	85972°	85973°	85973°
2002-2000	Yukon (Chevy Tahoe)	85662-5	85672-5						
1999-1992	Yukon (Chevy Tahoe) (Lens and Housing)	85352-5	85362-5						
1999-1992	Yukon (Chevy Tahoe) (w / o, Sgl HL)			86141°	86151°				
1999-1992	Yukon (Chevy Tahoe) (Early Design, Single HL)							86043°	86053°
1999-1992	Yukon (Chevy Tahoe) (Connector Plate Housing)	85450-5	85460-5						
1993-1992	Yukon (Chevy Tahoe) (Grey Trim, Dual HL)	86161°	86171°						
1993-1992	Yukon (Chevy Tahoe) (Dual Headlamps (Yukon))							86063°	86073°
1993-1992	Yukon (Chevy Tahoe) (Reflector, Dual HL (Yukon))							86083°	86093°
Izuzu*									
2000-1996	Hombre	85532-5	85542-5						
Jeep*									
2001-1997	Cherokee	86370°	86380°						
1996-1984	Cherokee	86390°	86400°						
1995-1987	CJ-5, CJ-7, Scrambler, Wagoneer, Wrangler						85993°	85993°	
1980-1976	CJ-5, CJ-7, Scrambler, Wagoneer, Wrangler (Red)					86032°	86032°		
1980-1976	CJ-5, CJ-7, Scrambler, Wagoneer, Wrangler (Yel)							86033°	86033°
2006-1976	CJ-5, CJ-7, Scrambler, Wrangler (Entire Lamp)	50972-5	50972-5						
2006-1976	CJ-5, CJ-7, Scrambler, Wrangler (Lens Only)	91302	91302						
2006-1976	CJ-5, CJ-7, Scrambler, Wrangler (LED-Entire Lamp)	G5212°	G5202°						
1998-1993	Grand Cherokee	86360°	86740°						
1996-1984	Wagoneer	86390°	86400°						
1986-1976	Wagoneer (Clear)			86781°	86781°				
1986-1976	Wagoneer (Yellow)			86783°	86783°				
Nissan*									
2002-1998	Pathfinder	85902	85912						
1998-1996	Pathfinder	85882	85892						
1995-1987	Pathfinder	85922	85932						

° = new

Oldsmobile*

		S/T/T		Front Park and Turn		Rear Side		Front Side	
		Left	Right	Left	Right	Left	Right	Left	Right
2001-1996	Bravada	85682-5	85692-5						
1994-1983	Bravada (w/ o Trim)	85072-5	85082-5						
1994-1983	Bravada (Chrome Trim)	85172-5	85182-5						
1994-1983	Bravada (Black Trim)	85952°	85962°						
1994-1982	Bravada						85093-5	85103-5	
1993-1991	Bravada			85313-5	85323-5				
Plymouth*									
1980-1972	Power Wagon	85202-5	85192-5						
1993-1978	Van	85212-5	85222-5						
1977-1970	Van	86752°	86752°						
2000-1996	Voyager	85602-5	85612-5						
2000-1996	Voyager	85782-5	85792-5						
1995-1991	Voyager	85472-5	85482-5						
1990-1984	Voyager	85342-5	85332-5						
Toyota*									
2002-2001	Tacoma	85842-5	85852-5						
2000-1995	Tacoma	85822-5	85832-5						
2004-2003	Tundra	86720°	86730°						
2002-2000	Tundra	85862-5	85872-5						

° = new

REPLACEMENT LENS ASSEMBLIES



85002-5, 85003-5



85013-5, 85023-5



85033-5, 85043-5



85052



85053-5, 85063-5



85062



Without Trim: 85072-5, 85082-5
With Trim: 85172-5, 85182-5



85093-5, 85103-5



85112-5, 85122-5



85132-5, 85142-5



85152-5, 85162-5



85172-5, 85182-5



85192-5, 85202-5



85212-5, 85222-5



Without Trim: 85232-5, 85242-5
With Trim: 85252-5, 85262-5

REPLACEMENT LENS ASSEMBLIES



85273-5, 85283-5



85292-5, 85302-5



85313-5, 85323-5



85332-5, 85342-5



85352-5, 85362-5



85372-5, 85382-5



85392-5, 85402-5



85412-5, 85422-5



85432-5, 85442-5



85450-5, 85460-5



85472-5, 85482-5



85493-5, 85503-5



85512-5, 85522-5



85532-5, 85542-5



85552-5



85562-5, 85572-5



85582-5, 85592-5



85602-5, 85612-5



85622-5, 85632-5



85642-5, 85652-5



85662-5, 85672-5



85682-5, 85692-5



85702-5, 85712-5



85722-5, 85732-5



85742-5, 85752-5



85762-5, 85772-5



85792-5, 85782-5



85812-5, 85802-5



85822-5, 85832-5



85842-5, 85852-5

REPLACEMENT LENS ASSEMBLIES



85862-5, 85872-5



85882, 85892



85902, 85912



85922, 85932



85941

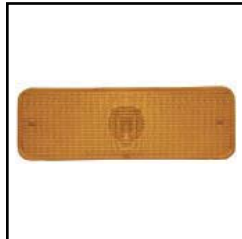

85943



85972



85973



85982

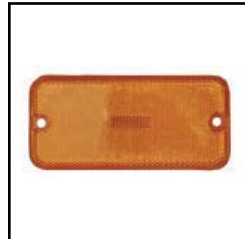

85983



85993



85952, 85962

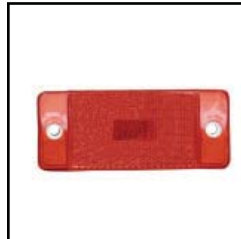

86002

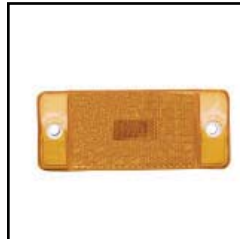

86003



86013, 86023



86032

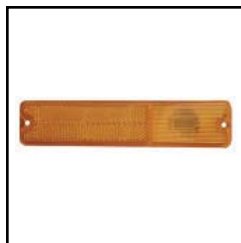

86033



86043, 86053



86063, 86073



86083, 86093



86103, 86113



86141, 86151



86161, 86171



86121, 86131



86180, 86190



86202, 86212



86221, 86231



86252, 86242



86282, 86292



86262, 86272

REPLACEMENT LENS ASSEMBLIES



86342, 86352



86370, 86380



86390, 86400



86360, 86740



86322, 86332



86302, 86312



86412, 86422



86432, 86442



86452, 86462



86472, 86482



86492, 86502



86512, 86522



86532, 86542



86573



86583, 86593



86603, 86613



86622, 86632



86642, 86652



86680



86703, 86713



86752



86762, 86772



86781



86783

REPLACEMENT LENSES

Lens Model Number	Fits Lamp	Lens Model Number	Fits Lamp	Lens Model Number	Fits Lamp	Lens Model Number	Fits Lamp	Lens Model Number	Fits Lamp	Lens Model Number	Fits Lamp
90011	62151	90232 (Cont.)	50862-5	90652	52482	91302 (Cont.)	53702	92062	G5300	93005 (Cont)	77675
	63001		55220		52492		53712		G5300-5		77685
90012	50222		55232	90742	51042	91302	53722	92063	G5300-5		77735
	50232		55242		51102		53762	92162		93013	77013
	50262		55280		51142-5	91311	62151	92163	46803	93015	77015
	50272		55290		51192		62201	92172	46862	93043	64093-5
	50352	90233	50630		51242-5	91482	50852	92173	46863	93053	64213-5
	50502		55220		51342-5		50862	92183	46433	93131	64371-5
	52522		55233		52002		50872		46813	93151	64541-5
	55032		55243		52082	91502	55410		47183		64551-5
	55092		55253		52112		55420	92193	46823	93163	63451-4
	55132		55280		52122		55430	92313	64163-5		63441-4
	55202		55290	90743	52112		55440	92382	52362		63401-4
90013	55033	90235	50635		52122		55450		52372		63431-4
	55133		55285	90752	51042		55460	92402	65340-5		63461-4
90022	50422		55295		51102		55470	92432	46882		63471-4
	50572		50655		51192	91503	55410		49112		63455-4
	50582		55225		51242-5		55420	92433	46883	93171	64481-5
	55172		55235		51342-5		55430	92453	76033		64501-5
90052	45012	90252	50852		52002		55440	92611	61371	93252	45512
	45172		50862		52082		55450	92691	47051		45522
90053	45013		50882		52112		55460	92692	47052	93283	76043
	45173		50892		52122		55470	92693	47053		76063
90072	45662	90301	45021-5	90762	50242	91513	55340	92761	62291		76053
	45712	90302	45022		50342		55410	92762	53132	93383	76963
	47262		45032		52612		55420	92763	53133	93392	46002
	47252		45122		52732		55430	92773	45993	93491	61651
90073	45663		49002		52752		55440	92792	52302		61671
	45713	90303	45023		55112		55450		52312		61641
	47263		45033		55122		55452	92833	76463		61611
	47253		45123		55532		55460	92841	76903	93532	45522
90092	78002	90305	45025-5		55552		55462	92883	76803		45612
	78150	90342	50532	90922	46282	91572	45262		76923	93533	45653
	78152		50542		46292		45432		76933		45573
90093	78003		50712		46892		49072	92885	76805		45613
	78150		50722		46892		49072		76935		45613
	78153	90352	76082	90923	46283	91573	45263	92892	52022		45913
	78303	90353	76083		46293		45433		52062		45843
90103	78003	90355	76085		46893		49073	92893	52023	93651	60431
	78103	90363	76243	91042	46302	91581	60311		52063		60441
90121	61081	90371	76203		46312		63051	92901	61511		61451
90122	46492-5	90372	76222	91043	46303	91582	53000	92943	47243	93652	47532
	46702		76283		46313		53020		47363		45762
	49072	90373	76203	91101	61091		53052	92993	77123		45782
90123	46493-5		76223		61161		56000		77703	93653	45762
	46703		76283	91112	46392		56020		77723		45782
	49073	90375	76205		46392-5		56032		77503	93701	7764x
90133	45333		76225		50532		56042	92995	77692		7765x
90143	45383		76285		50532-5		56052		77612		7766x
90142	45382	90383	76163		50542	91583	53000		77632		7767x
90152	45252		76183		50542-5		53010	93001	77671		7768x
	49062		76193	91113	49393		53020		77641		7771x
	45672	90385	76165		46393-5		53023		77711		7773x
90153	45253		76185	91122	46442		56000		77731	93723	77473
	45673	90393	16062	91152	50532		56010	93002	77682		77483
90162	45412		16063		50542		56020		77642	93891	61791
	45222		16172		46392	91683	46543		77662	93923	61793
	49042		16173	91153	46393	91961	46791		77652	94082	46632
90163	45413		16223	91172	46782	91962	46782		77712	94083	46633
	45223	90401	61031		46792		G4602		77672	94092	46642
90172	45462		61221	91173	46783		G4602-5		77732	94093	46643
	45442	90482	55340		46793	91963	46783		77743	99802	46332
90173	45463	90483	55340	91302	50902		46793	93003	77733	99803	46333
	45443		64241		50912		G4603		77643	99832	78322
90202	45932		64251		50942	91964	46784		77663	99833	78333
	46712		64261-4		50952		46794		77653	99842	56072
90203	45933		64271		50972		46785		77713		50132
	46713		64281		50992	91965	46795		77133	99843	56073
90221	62011		64291-4		52602	91992	46772		77593	99863	56083
	62021	90512	50402		52802	91993	46773		77673	99871	56071
90232	50630		50412		52812	92031	77101		77683	99872	56072
90232	50652	90642	52462		52832	92032	77102	93005	77645	99912	46322
	50662		52472		52902	92033	77103		77665	99913	46323
	50852		51982		52912		77203		77655		
	50852-5		51992		52972	92035	77105		77715		
	50862										

Lenses

Lentilles Micas

L E N S E S

REPLACEMENT LENSES



90011, 90012,
90012-5, 90013



90022



90051, 90052,
90053



90062, 90063

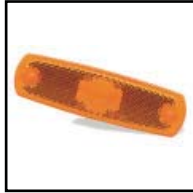

90072, 90073



90092, 90093



90103



90121, 90122,
90123, 90122-5,
90123-5



90133



90142, 90143



90152, 90153,
90152-5, 90153-5



90162, 90163



90172, 90173



90202, 90203,
90202-5, 90203-5



90221



90232, 90233,
90235



90252



90301, 90302,
90302-5, 90303,
90305



90342, 90342-5



90352, 90353,
90355



90363



90371, 90372, 90373,
91323 LEXAN,
90375



90383, 90385



90393



90401



90481, 90482,
90483



90512



90642



90652



90752



90742, 90743



90761, 90762



90922, 90923



91042, 91043



91101

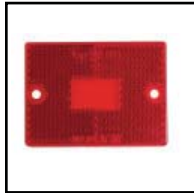

91112, 91113

REPLACEMENT LENSES



91122

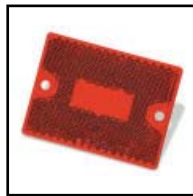

91152, 91153



91172, 91173



91302



91311



91482

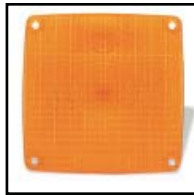

91502, 91503



91513



91572, 91573



91581, 91582,
91583



91683



91961, 91962, 91963,
91964, 91965, 91962-5,
91963-5



91992, 91993



93013, 93015



92031, 92032,
92033, 92035



92062, 92063



92162, 92163



92172, 92173



92183



92193



92313



92382

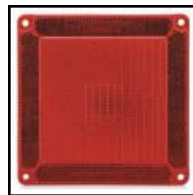

92402



92432, 92433



92453



92611

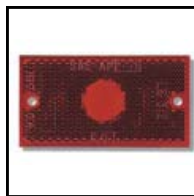

92691, 92692, 92693



92761, 92762,
92763



92773



92792



92833

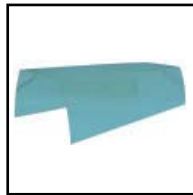

92841



92883, 92885



92892, 92893

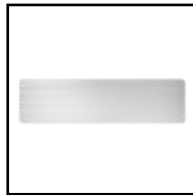

92901

REPLACEMENT LENSES



92943



92993, 92995



93001, 93002,
93003, 93005



93043



93053



93131



93151



93163



93171



93252



93283



93383



93393



93491

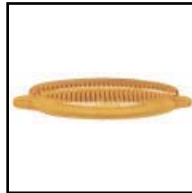

93531, 93532, 93533



93651, 93652,
93653



93701



93723



93923



94082, 94083



94092, 94093



99802, 99803

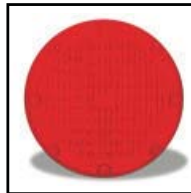

99832, 99833



99842, 99843



99863

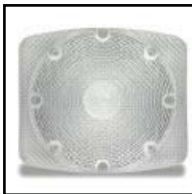

99871, 99872



93891



99912, 99913

MECHANIC'S LED FLASHLIGHT

Popular black finish on impact-resistant aluminum body • Bright 1-Watt LED uses 3 AA batteries • Retail packaged for visual impact at point of sale • Removable head and flexible attachment allow for hands-free use so the user can shine light where it is needed • Can be used as a handheld flashlight, cross hatched handle improves grip • Extension may be posed to allow for hands free purposes and provides a light source for hard-to-reach areas • Order 4 pieces and receive shelf point-of-purchase display

98001-5 Black, Retail Pack **new**

Finish: Black
Volts / Amps: 4.5V / .22A

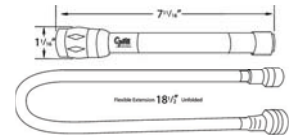

WIRE AND CABLE INSTALLATION AND REPAIR KIT

Kit includes: 9" heavy duty cable cutter (84-9088), cable tie tension and cutter tool (83-6509), heavy duty rotary cable stripper / splitter (83-6515), heavy-duty wire stripper / cutter 22-10 gauge (83-6512), 22-10 gauge ratchet terminal crimping tool (83-6511)

83-6553 Repair Kit **new**



ELECTRICAL TERMINATION AND REPAIR KIT

Kit includes: flameless heat gun (83-6508), cable tie tension and cutter tool (83-6509), heavy-duty rotary cable stripper / splitter (83-6515), heavy duty wire stripper (83-6512), 22-10 gauge ratchet style terminal crimping tool (83-6511)

83-6552 Repair Kit **new**



RATCHET CRIMPING TOOL

Ratchet tool properly crimps heat shrink and crimp solder and seal terminals • Specially designed die ensures a clean crimp that protects the heat shrink jacket from over crimping • 22-8 gauge is the largest crimp range in the industry • Ergonomic design for easy use; a must have for any mechanic, installer or repair professional

83-6519 22-8 Gauge Tool **new**



Tools and Repair

Outils et réparation Herramientas y accesorios para reparaciones eléctricas



INSULATED / NON-INSULATED RATCHET TERMINAL CRIMPER

Crimps insulated and non-insulated terminals 22-10 gauge • Ergonomic handle for safety and ease of use • High-end hand-crimping tool

83-6511 22-10 Gauge **new**



CRIMPER STRIPPER AND CUTTER

Crimps insulated and non-insulated terminals 22-10 gauge • Self-adjusting wire stripper for 26-10 gauge wire • Built in cutter • Makes a clean cut and crimp without damaging the conductor • Cushion grip for comfort • Adjustable stopper for a clean strip every time • 8" long

83-6512 Heavy Duty Tool **new**



WIRE STRIPPER (OEM)

Stripping tool with precision blades • Self-adjusting wire stripper for 26-8 gauge wire • Makes a clean strip without damaging the wire strands • Cushion-grip for comfort

83-6513 26-8 Gauge **new**



PVC AND IGNITION TERMINAL CRIMPER AND WIRE STRIPPER

10" long • For professional crimps on electrical terminals and ignition wires • Strips wire 22-10 gauge

83-6518 Crimping Tool **new**



CRIMPER AND CUTTER "ECONOMY"

8" long • Cuts and strips primary wire 22-10 gauge sizes • Crimps insulated and non-insulated terminals 22-10 gauge • Sure grip vinyl handle for safety

83-6510 22-10 Gauge **new**



PACKARD-STYLE OPEN-BARREL CRIMPER (OEM)

Used for open-barrel OEM Packard-style connectors • Can crimp non-insulated terminals 22-10 gauge • Heavy duty construction • Ergonomic design • 10" Long

84-9449 Crimping Tool **new**

TERMINAL REMOVER-WEATHER PACK (OEM)

Use to release most Packard*, GM*, Ford* and Chrysler* OEM terminals from their insulated housings • OEM approved • OEM PN 12014012

84-9450 Terminal Remover



CABLE SLITTER / STRIPPER

Slits and strips round battery and trailer cables • Self-adjusting cutting depth • Makes a clean strip without damaging wire strands • Blade swivels for longitudinal / spiral cuts

83-6515 Cable Stripper **new**



GUN STYLE CABLE TIE TENSIONER AND CUTTER

Cable tie tension and cut-off tools reduce operator fatigue and speed assembly • Ergonomic design fits the operators hand comfortably • Cushion grip for comfort • Quick tension adjustability for a flush "cut-off" • Equipped with a hook for easy hanging

83-6527 Light-Duty: 18-50 lbs **new**

83-6528 Heavy-Duty: 18-250 lbs **new**



CABLE TIE TENSIONER AND CUTTER "TWISTER TOOL"

Compact tensioning tool enables cinching and cutting • For cable ties ranging from 18 lbs - 50lbs tensile strength • Twisting action leaves a clean edge to prevent chaffing of wires • Lightweight ergonomic design • 7" Long

83-6509 Cable Tie Cutter **new**



FLAMELESS HEAT GUN

Portable, self-igniting, multi-function heat tool • Comes with an attachable heat deflector, cooling tray and replacement orifice • The wide nozzle has a high-output, long-life catalyst • Ready to use in 15 seconds • Adjustable heat settings • Cordless and flameless • OEM approved • Continuous operating temperature: (480°F to 930°F) • Maximum Heat: 1400°F • Gas container capacity: 20 ml • Recommended butane: triple refined; (not included)

83-6508 Heat Gun **new**



Tools and Repair

Outils et réparation Herramientas y accesorios para reparaciones eléctricas



BUTANE-POWERED MICRO-TORCH

Self-igniting trigger switch with safety lock • Adjustable flame • Powered by refillable fuel cell • 20-minute run time • Maximum Temperature Rating: 2500°F • Butane not included

83-6500 Micro Torch **new**



HEAT GUN

Two heat settings; 120 volt, 10 amp • Lightweight (11lb) • 3-wire ground cord set • UL and CUL listed • Thermoplastic case • Minimum Temperature Rating: 500°F • Maximum Temperature Rating: 1000°F

83-6501 Heat Gun



DUAL-WALL, ADHESIVE-LINED "HOT-MELT" HEAT-SHRINK TUBING KIT

4:1 shrink ratio • Forty, 6" black dual wall heat shrink pieces: (12) 84-5006, (12) 84-5007, (10) 84-5008, (6) 84-5009 • 6-compartment re-closable box • Reorder chart on inside cover

83-6535 Kit **new**



DUAL-WALL, FLEXIBLE, ADHESIVE-LINED HEAT SHRINK TUBING KIT

3:1 Shrink Ratio • Fifty, 6" black flexible dual wall heat shrink pieces, (12) 84-4015, (12) 84-4016, (12) 84-4017, (6) 84-4018, (6) 84-4019, (2) 84-4020 • 6 compartment re-closable box • Reorder chart on inside cover

83-6537 Kit **new**



RED / BLACK, DUAL-WALL, HEAT-SHRINKABLE TUBING KIT

Combination of fifty, 6" red and black dual-wall heat-shrink pieces, six each of 84-4006, 84-6106, 84-4005, 84-6105, 84-4000, 84-6100, 3 each of 84-4001, 84-6101, 84-4002, 84-6107, one each of 84-4003, 84-6103 • 3:1 Shrink Ratio • 6-compartment re-closable plastic box • Reorder chart on the inside cover

83-6505 Kit **new**

DUAL-WALL, BLACK, HEAT-SHRINKABLE TUBING KIT

3:1 shrink ratio • Fifty, 6" black dual-wall heat-shrink pieces (12) 84-4006, (12) 84-4005, (12) 84-4000, (6) 84-4001, (6) 84-4002, (2) 84-4003 • 6-compartment re-closable plastic box • Reorder chart on inside cover

83-6502 Kit **new**



SINGLE WALL, BLACK HEAT SHRINK TUBING KIT

2:1 Shrink Tubing • 50, 6" black dual wall heat shrink pieces 84-5010 (12), 84-5011 (12), 84-5012 (12), 84-5013 (6), 84-5014 (6), 845015 (2) • 6-compartment re-closable plastic box • Re-order chart on inside cover

83-6545 Kit **new**



CRIMP, SOLDER & SEAL TERMINAL AND CONNECTOR ASSORTMENT KIT

120 of the most popular heat shrink crimp, solder and seal terminals and connectors: - rings (50), butts (40), spades (10) and quick disconnects (20) • 20-18, 16-14 and 12-10 gauges • 12-compartment re-closable plastic box with reorder chart

83-6542 Kit **new**



HEAT-SHRINK, SOLDER TERMINAL AND CONNECTOR ASSORTMENT KIT

120 of the most popular solder and seal terminals and connectors • Includes rings (50), butts (50), spades (10) and quick disconnects (20) • 22-18, 16-14 and 12-10 gauges • 12-compartment re-closable plastic box with reorder chart on the inside cover

83-6539 Kit **new**



HEAT-SHRINK TERMINAL AND CONNECTOR ASSORTMENT KIT

120 of the most popular heat shrinkable crimp splices and terminals • Includes (50) ring, (40) butt, (10) spade and quick (20) disconnect terminals in various gauges • 12-compartment plastic box with reorder chart on the inside cover

83-6503 Kit **new**



Tools and Repair

Outils et réparation Herramientas y accesorios para reparaciones eléctricas



NYLON TERMINAL AND CONNECTOR ASSORTMENT KIT

120 of the most popular Nylon terminals and connectors • Includes: (50) rings, (40) butts, (10) spades and (20) quick disconnects • 22-18, 16-14 and 12-10 gauges • 12 compartment re-closable plastic box with reorder chart on the inside cover

83-6538 Kit **new**



VINYL & NYLON TERMINAL AND CONNECTOR ASSORTMENT KIT

Kit contains 650 of the most popular automotive electrical terminals and accessories • Assorted gauges (22-18, 16-14, 12-10) and stud sizes (#6 - 1/4") • Matrix chart on inside lid describes piece parts, provides illustrations and details individual re-order part numbers

83-6540 Kit **new**



AUTO ELECTRIC REPAIR KIT

208 electrical tools and components • Voltage tester and test leads • Assorted ring, butt, spade and quick-disconnect wire terminals • Terminal crimping tool • Primary wire • Cable ties, shrink tubing and nylon wire clamps • Glass and ATO emergency fuses and a fuse puller • Battery brush • Miniature screwdrivers

83-6550 Kit **new**



ECONOMY TERMINAL KIT

50 assorted vinyl terminals and connectors, 22-10 gauge • (5) 84-2180, (5) 84-2380, (5) 84-2580, (5) 84-2303, (5) 84-2104, (5) 84-2304, (5) 84-2191, (5) 84-2391, (5) 84-2187, (5) 84-2387, (1) 83-6510

83-6520 Kit **new**



ALL PURPOSE TERMINAL KIT

37 pieces: 2 miniature screwdrivers, electrical pliers and circuit tester, assorted wire terminals and a heavy-duty terminal crimping tool

83-6530 Kit **new**

“WEATHER PACK” TERMINAL AND CONNECTOR REPAIR KIT (OEM)

Kit includes 250 assorted pieces: assorted 22-14 GA terminals; 1, 2 and 4 cavity nylon housings; 22-18 and 16-14 GA cables seals • Sturdy plastic container keeps all connectors in one location • Easy-to-use reference reorder chart included • Use Grote OEM crimping tool 84-9449 and extractor tool 84-9450 for superior connection and repair (tools sold separately)

83-6536 Kit new



DOOR HINGE REPAIR KIT

Replacement for 87250, 87860, 87240, 87220, and 87850 • Kit contains: 1 Brass Hinge Pin, 1 Door and 1 Spring

99680 Repair Kit



LAMP AND HARNESS TESTERS

Troubleshoot lamp or wiring problems in minutes with these handy tools

87890 Lamp Tester and Harness for S / T / T and C / M lamps
87891 Circuit Chaser for 7-Pin Receptacle

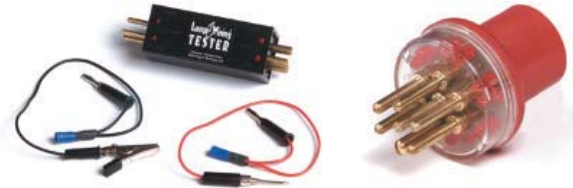

7-PIN RECEPTACLE INSERT REPAIR KIT

Replacement pin kit for 87140

97900 Repair Kit new



DOOR HINGE REPAIR KIT

Replacement door kit for 87140

97910 Repair Kit new



Military Lighting

Éclairage pour usage militaire Lámparas para uso militar

LED

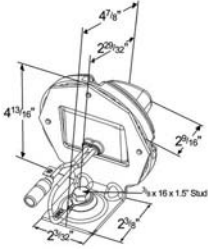

LED BLACKOUT DRIVING LAMP

Operates from 10- to 34-Volts to accommodate 14- and 28-Volt systems

- Durable lightweight polycarbonate lens and housing
- Circuit board design eliminates the threat of detectable lamp EMI
- Improved optics for more useful light output than previous designs
- Complies with MILSTD1179, MILSTD461E and follows STANAG4381 guidelines
- Molded colors: Green 34094, Tan 33446, Black 37031

- 82135** Blackout, Desert Tan ● new
82485 Blackout, Desert Tan, No Bracket ● new
82005 Blackout, Military Green ● new
82635 Blackout, Military Green, No Bracket ● new
82145 Blackout, Black ● new

Material: Polycarbonate / Steel
 Finish: Desert Tan / Military Green / Brown / Black
 Volts / Amps: 14-28V / .015A (Blackout Drive)
 Accessory: 82005 = NSN6220-01-542-7774, 82135 = NSN6220-01-542-7765, 82145 = TACOM drawing 12518338

LED

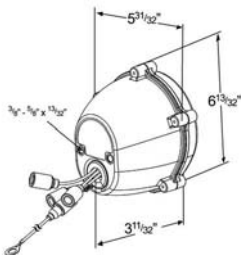
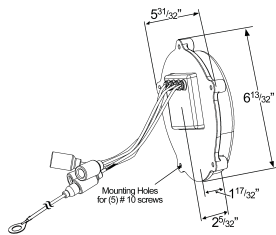

FRONT TURN / PARK, COMPOSITE LED LAMP WITH BLACKOUT FUNCTION

Operates from 10- to 34-Volts to accommodate 14- and 28-Volt systems

- Designed with standard military connectors to interface with MS27144-2
- Bucket-mount version can easily be removed / installed with standard and Phillips screwdrivers
- Yellow, zinc-plated steel hardware
- Textured lens to reduce glare
- Designed to comply with FMVSS108 and MILSTD1179; also follows STANAG 4381 guidelines
- Lamp for use on vehicles 80" or wider

SURFACE MOUNT:

- 82153** Yellow, Desert Tan ● new
82013 Yellow, Military Green ● new
82203 Yellow, Black ● new

WITH BUCKET:

- 82193** Yellow, Desert Tan ● new
82033 Yellow, Military Green ● new
82163 Yellow, Black ● new

HMMWV APPLICATIONS:

- 82313** Yellow, Desert Tan ● new
82303 Yellow, Military Green ● new
82593 Yellow, Black ● new

Material: Polycarbonate / Nylon
 Finish: Desert Tan / Military Green / Black
 Volts / Amps: 14V / .81A (I) / .16A (P)
 Volts / Amps: 28V / .415A (I) / .088A (P)
 Volts / Amps: 14V - 28V / .012A (Blackout Marker)
 Volts / Amps: 14V / 1.10A (I-HMMWV)
 Volts / Amps: 28V / .995A (I-HMMWV)
 Accessory: 82593 = TACOM drawing 12518339; 82153 = NSN6220-01-544-5900; 82013 = NSN6220-01-544-5833; 82193 = NSN6220-01-544-5905; 82033 = NSN6220-01-544-5896

LED REAR STOP /TAIL /TURN COMPOSITE LAMP WITH BLACKOUT FUNCTION

Operates from 10- to 34-Volts to accommodate 14- and 28-Volt systems
 • Designed to use military connectors to interface with MS27144-2
 • Bucket mount can be easily installed / removed with standard and Phillips screwdrivers • Durable polycarbonate lens, housing and bucket • Yellow, zinc-plated steel hardware • Textured lens to reduce glare • Designed to comply with FMVSS108 and MILSTD1179 Standards as well as follows STANAG4381 guidelines • Molded housing colors: Green 34094, Tan 33446, Black 37031 • Lamp for use on vehicles 2032 mm or wider



SURFACE MOUNT:

- 82172** Red, Desert Tan ● new
- 82022** Red, Military Green ● new
- 82222** Red, Black ● new

WITH BUCKET:

- 82212** Red, Desert Tan ● new
- 82042** Red, Military Green ● new
- 82182** Red, Black ● new

HMMWV APPLICATIONS:

- 82332** Red, Desert Tan ● new
- 82322** Red, Military Green ● new
- 82602** Red, Black ● new

Material: Polycarbonate / Nylon
 Finish: Desert Tan / Military Green / Black
 Volts / Amps: 14V / .205A (I, S) / .029A (T)
 Volts / Amps: 28V / .110A (I, S) / .024A (T)
 Volts / Amps: 14V - 28V / .0116A (Blackout Tail / Stop)
 Volts / Amps: 14V / .205A (I-HMMWV)
 Volts / Amps: 28V / .110A (I-HMMWV)
 Accessory: 82062 = TACOM drawing 12518337,
 82172 = NSN6220-01-544-5789, 82022 = NSN6220-01-544-5796,
 82212 = NSN6220-01-544-5775, 82402 = NSN6220-01-544-5793

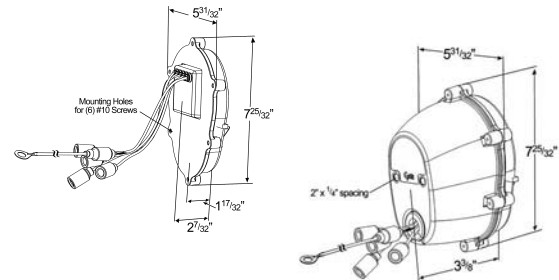

MILITARY HMMWV RETROFIT KIT

One part number to order for complete kit: consists both Front and Rear Composite Lamps and the Blackout Drive Lamp • No painting of lamps necessary; Tan, Green and Black kit match military color chips • Lamps are a direct replacement drop-in; no alterations to the vehicle are needed

- 82340-5** Military Green ● new
- 82350-5** Desert Tan ● new
- 82640-5** Black ● new



Material: Polycarbonate / Nylon
 Finish: Military Green (34094), Desert Tan (33446), SOCOM Black (37031)

MILITARY-STYLE DIE-CAST ALUMINUM CLEARANCE / MARKER LAMPS

Compliant with FMVSS 108 • 14-gauge jacketed wire • Military Green housing color 34094 • 5.1" long housing will fit inside "bucket" installations • Can be grounded via mounting screw • Mounting pad included
 • Replaces 12338610-1/2 and MS35423-1/2 • Easy to install; can be mounted directly without disassembly, unlike competitive models
 • Designed with standard military connectors to interface with MS27144-2

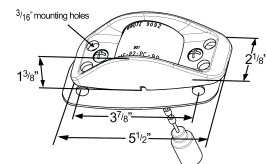

- 82062** Red, Military Green ● new
- 82063** Yellow, Military Green ● new

Material: Aluminum / Acrylic
 FMVSS: P2, PC
 Finish: Military Green
 Bulb: 464 Volts / Amps: 28V / .17A / 4.76-Watt
 Lens: Red: 90922, Yellow: 90923

These items may be subject to U.S. export control laws. Export of such items may require prior authorization from the U.S. Government, including the U.S. Commerce Department's Bureau of Industry and Security or the State Department's Directorate of Defense Trade Controls. Unauthorized export, re-export, or diversion contrary to U.S. law is prohibited.

Military Lighting

Éclairage pour usage militaire Lámparas para uso militar

LED

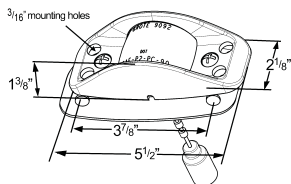

MILITARY-STYLE DIE-CAST ALUMINUM CLEARANCE / MARKER LED LAMP

Compliant with FMVSS 108 • 14-gauge jacketed wire • Military Green 34094 or Desert Tan 33446 housing color • 5.1" long housing will fit inside "bucket" installations • Can be grounded via mounting screw
 • Mounting pad included • Replaces 12338610-1/2 and MS35423-1/2
 • Easy to install; can be mounted directly without disassembly, unlike competitive models • Designed with standard military connectors to interface with MS27144-2

- 82102** Red, Desert Tan ● new
82103 Yellow, Desert Tan ● new
82112 Red, Military Green ● new
82113 Yellow, Military Green ● new

Material: Aluminum / Acrylic
 FMVSS: P2
 Finish: Military Green / Desert Tan
 Volts / Amps: 24V / .053A
 Lens: Red: 90922, Yellow: 90923

LED

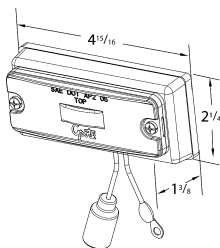

LOW PROFILE LED CLEARANCE / MARKER LAMPS WITH INTEGRATED REFLECTOR

Multi-volt circuitry functional on either 14- or 28-Volt electrical system
 • LEDs provide long life and low amperage draw • Utilizes standard military connectors to interface with MS27144-2 • Low-profile, durable housing • Bracket utilizes screws that can be removed / tightened with either a standard or Phillips screwdriver

- 82442** Red, Lamp Only with Gasket ● new
82443 Yellow, Lamp Only with Gasket ● new
82122 Red, Green Kit ● new
82232 Red, Tan Kit (82442 + 82490) ● new
82762 Red, Black Kit (82442 + 82492) ● new
82123 Yellow, Green Kit ● new
82233 Yellow, Tan Kit (82443 + 82490) ● new
82763 Yellow, Black Kit (82443 + 82492) ● new

Material: Polycarbonate / ABS
 FMVSS: J592, J5594, P2, A
 Finish: Military Green-34094, Desert Tan-33446
 Volts / Amps: 13.5V or 28V / .06A
 Bracket: Tan 82490; Black 82492

MILITARY-STYLE SURFACE MOUNT LED DOME LAMPS

Multi-volt versions operate on a variety of systems giving you ultimate flexibility • Standard military connectors and fasteners for easy retrofit and replacement • Replaceable lens • Lamps 82081, 82082 and 82085 use TACOM plugs • Lamps 82370, 82390, 82080, 82380 and 82400 use Amp-style plugs • Lamp circuitry protects against excess current

- 82071** White, Black, High Output, 9V-30V ● new
- 82081** White, Black 9V-30V ● new
- 82085** Blue, Black, 9V-30V ● new
- 82370** White / Red, Black, 10V-16V ● new
- 82390** White / Blue, Black, 10V-16V ● new
- 82080** White / Red, Black, 10V-32V ● new
- 82380** White / Red, Black, 18V-32V ● new
- 82400** White / Blue, Black, 18V-32V ● new

Material: Polycarbonate / Aluminum
 Finish: Gray / Black
 Volts / Amps: 82071 - 9V / .65A; 30V / .115A
 Volts / Amps: 82081 - 9V / .342A; 30V / .094A
 Volts / Amps: 82080 - 12.8V / .250A; 25.6V / .140A
 Volts / Amps: 82085 - 30V / .142A; 12.8V / .210A; 25.6V / .1A
 Volts / Amps: 82370, 82390 - 14V / .235A
 Volts / Amps: 82380, 82400 - 25.6V / .125A
 Lens: Clear 90401



MILITARY STYLE LED MAP LIGHT

Military connectors: female plug MS 27144-2 and male plug MS 27142-3
 • Red version for night-vision goggle compatibility in tactical mode
 • Airplane-style "eye" can be positioned to place light where needed
 • On / Off switch on the base of lamp • Operates from 10- to 30-Volt to accommodate 14- or 28-Volt systems

- 82091** White ● new
- 82092** Red, High Output ● new

Material: Polycarbonate / Steel
 Finish: Black
 Volts / Amps: 82091- 10V / .135A; 30V / .050A
 Volts / Amps: 82092- 10V / .110A; 30V / .040A



3" ROUND REFLECTOR WITH GASKET

Recessed lens for extra protection • Lens gasket cushions lens and protects prisms against dirt and moisture

- 40162** Red, Green Base new
- 40163** Yellow, Green Base new

FMVSS: A
 Finish: Military Green 34094



MILITARY STYLE STEEL HOUSING REFLECTORS

Extra deep lens recessed for protection • Lens gasket cushions lens and protects prisms against dirt • Available in Military Green or Desert Tan for multiple theater application

- 82552** Red, Green Housing new
- 82553** Yellow, Green Housing new
- 82562** Red, Tan Housing new
- 82563** Yellow, Tan Housing new

Material: Steel / Acrylic
 FMVSS: A
 Finish: Military Green 64094, Desert Tan 33446



These items may be subject to U.S. export control laws. Export of such items may require prior authorization from the U.S. Government, including the U.S. Commerce Department's Bureau of Industry and Security or the State Department's Directorate of Defense Trade Controls. Unauthorized export, re-export, or diversion contrary to U.S. law is prohibited.

European Approved Lighting

Éclairage Européen Approuvé Lámparas con aprobación europea

LED



46173

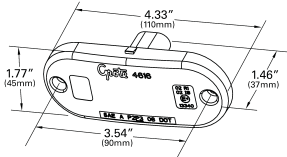

EU-SERIES OVAL LED MARKER LAMP

Mounts direct or uses "L" bracket (42222) • Integral super-seal terminal system for robust connections • Circuit board encapsulated and protected in epoxy sealant

- 46161** Front Position, Clear, Amp Connector ● new
- 46162** Rear Position, Red, Amp Connector ● new
- 46163** Side Marker, Yellow, Amp Connector ● new
- 46173** Side Marker, Yellow, Amp Connector w / Bracket (46163 + 42222) ● new
- 42222** Bracket Only

Material: Acrylic / ABS
 Finish: Red / Yellow / Clear
 Volts / Amps: 9V - 33V / .065A at 13.5V
 Bracket: 42222

LED

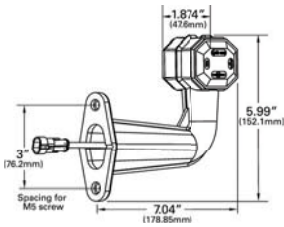

EU-SERIES STALK OCTAGON LED LAMP

Integral super-seal connector on the harness

- 46180** Left-Hand Bent Arm ● new
- 46190** Right-Hand Bent Arm ● new
- 46200** Straight Arm ● new

Material: Rubber / Polycarbonate
 Finish: Black
 Volts / Amps: 9V - 33V / .038A at 12V / .039A at 24V

LED

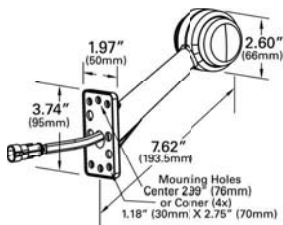

EU-SERIES STALK ROUND LED LAMP

Integral super seal connector on harness • Includes side marker function

- 46230** Bent-Arm, Left-Hand Stalk ● new
- 46240** Bent-Arm, Right-Hand Stalk ● new
- 46250** Bent-Arm, Left-Hand Stalk w / End Lamp ● new
- 46260** Bent-Arm, Right-Hand Stalk w / End Lamp ● new

Material: Rubber / Polycarbonate
 Volts / Amps: 12V - 24V / .046A at 12V / .055A at 24V

EU-SERIES STOP / TAIL / TURN LAMP

Multi-function stop / tail / turn lamp module with reflex • Integral connector molded into housing • Standard functions include: stop, turn, rear position, side marker, fog, reverse and rear reflex license (54402 / 54412)

- 54402** Left-Hand Tail Lamp w / License Function ● new
- 54412** Right-Hand Tail Lamp w / License Function ● new
- 54422** Left-Hand Tail Lamp ● new
- 54432** Right-Hand Tail Lamp ● new

Material: Polycarbonate / Acrylic
 Finish: Red / Yellow
 Volts / Amps: 24V

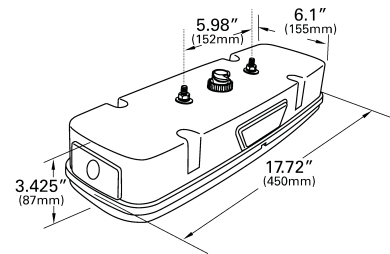

EU-LED LICENSE LAMP

Hermetically sealed lamp prevents water intrusion • Hard-wired with AMP connector • Indexed, snap-fit mounting to brackets

- 65820** 12-Volt new
- 65830** 24-Volt ● new

Material: Polycarbonate
 Finish: Clear
 Bulb: 12V / .033A
 Bulb: 24V / .024A
 Bracket: 43962

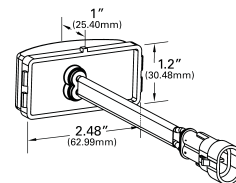

LIMITED WARRANTY

Grote Industries, Inc. ("Grote") warrants its products to be free from defects in material and workmanship under normal use and service as set forth in this Limited Warranty. THIS LIMITED WARRANTY is the final, complete and exclusive expression of warranty to the purchaser and cannot be modified except in writing signed by an authorized officer of Grote.

GENERAL ONE-YEAR LIMITED WARRANTY

Subject to the following conditions, Grote warrants to the original purchaser only (and not to anyone else) of each new product made by Grote that any part thereof which proves to be defective in material or workmanship within one year from the date of manufacture by Grote will, at Grote's option, be repaired or replaced without charge upon return to Grote of the defective product, provided any defect in the product is brought to the attention of Grote within the warranty period, who alone will be authorized to furnish or arrange for repairs or replacements within the terms of this limited warranty.

The above limited warranty does not apply, and no warranty, either expressed or implied, shall be applicable (a) to damage resulting from accident, alteration, misuse or abuse; (b) if the product is not installed, operated and maintained according to procedures recommended by Grote; (c) if the serial number, date code, or other identifying marks affixed to the product by Grote are removed, obliterated or defaced. In no case shall the warranty be extended to defects in materials, components (which includes but is not limited to bulbs), or services furnished by third parties nor to the installation of the product performed by third parties, except those performed by or on behalf of Grote authorized distributors. If any repairs are made, or any other parts are replaced during the warranty period, by any distributor other than a Grote distributor, in accordance with service manuals, parts, accessories, or attachments other than authorized by Grote for use in Grote's products, the purchaser shall pay for such repairs or parts without recourse against Grote; and Grote shall be relieved of responsibility for fulfillment of the warranty with respect to parts or components of all repairs, alterations, or replacements so made.

INSTALLATION GUIDELINES:

Grote Systems - Grote lamp assemblies and harness products are designed to function as a complete system; therefore, this limited warranty shall not extend to failure of any Grote products caused by the use of incompatible lamp assemblies, harness products or other components.

Heat - All electronic and lighting products produce heat. The installer is responsible for assurance that the application of the component will not result in contact with flammable material.

Surface Mount - The following procedures need to be practiced to ensure proper installation: The lamp should be placed on a level unobstructed surface. Number 10 screws should be tightened to 25 in. pounds of torque. Only Grote ULTRA-BLUE-SEAL® pigtails should interface with all Grote lamps. These guidelines will ensure the products will function and last as they were designed. Deviations from these guidelines will void any warranty.

Design Voltage and Current - Current is provided as an approximate value and is listed for the design voltage of the lamp. The design voltage of the lamp may vary. Customers should contact Grote Industries if detailed information is required.

IN CONSIDERATION OF THE EXPRESS WARRANTY AND OTHER TERMS HEREIN CONTAINED, THE PURCHASER AGREES THAT PURCHASER'S EXCLUSIVE REMEDY AND GROTE'S SOLE LIABILITY ON ANY CLAIM, WHETHER IN TORT, CONTRACT

OR WARRANTY, SHALL BE LIMITED TO, AT GROTE'S OPTION, REPAIR OR REPLACEMENT OF A DEFECTIVE PRODUCT. NO OTHER REMEDY (INCLUDING BUT NOT LIMITED TO INCIDENTAL OR CONSEQUENTIAL DAMAGES FOR THE LOST PROFITS, LOST SALES, INJURY TO PERSON OR PROPERTY; OR ANY OTHER INCIDENTAL LOSS OR DAMAGES) SHALL BE AVAILABLE TO PURCHASER. IN NO EVENT, AND FOR NO CAUSE WHATSOEVER, INCLUDING ANY BREACH OR DEFAULT BY GROTE, SHALL GROTE HAVE ANY MONETARY LIABILITY TO PURCHASER IN EXCESS OF THE PRICE PAID BY PURCHASER FOR THE PRODUCT IN QUESTION.

THIS LIMITED WARRANTY SUPERSEDES ALL OTHER EXPRESSED OR IMPLIED WARRANTIES, INCLUDING THE IMPLIED WARRANTY OF MERCHANTABILITY AND THE IMPLIED WARRANTY OF FITNESS FOR A PARTICULAR PURPOSE, AND OF ALL OTHER OBLIGATIONS OR LIABILITIES ON THE PART OF GROTE. NO DEALER, DISTRIBUTOR OR OTHER REPRESENTATIVE OF THE COMPANY IS AUTHORIZED TO CHANGE THIS WARRANTY IN ANY WAY OR TO GRANT ANY OTHER WARRANTY.

Any affirmation of fact or promise made by Grote shall not be deemed to create an expressed warranty that the products shall conform to the affirmation or promise. Any description of the product is for the sole purpose of identifying such product and shall not be deemed to create an express warranty that the product shall conform to the description. Any sample or product model is for illustrative purposes only and shall not be deemed to create an express warranty that the whole of the products shall conform to the sample or model. Furthermore no affirmation or promise, or description, sample or model shall be deemed a part of the basis of the bargain between Grote and the purchaser.

Grote assumes no responsibility that title conveyed to the purchaser is good or the transfer of title to the products is rightful, or that the products shall be delivered free from any security interest or other lien or encumbrance of any third party, or free from any rightful claim of any third party by way of infringement or otherwise.

NON-TRANSFERABLE

THIS WARRANTY SHALL EXTEND ONLY TO THE ORIGINAL PURCHASER AND IS NON-TRANSFERABLE.

EXCEPTIONS

The general one-year (1) limited warranty shall apply but shall be altered as set forth below for the following products:

- (1) Grote Torsion Mount® Blue Chip Series Lamps shall be subject to a three-year (3) limited warranty.
- (2) All Grote Sealed Lamps (12-Volt only) shall be subject to a two-year (2) limited warranty unless otherwise stated.
 - A) Grote Economy sealed lamps shall be subject to a one-year (1) limited warranty.
- (3) Conspicuity Tape shall be subject to a limited warranty. Please refer to the Grote web site for warranty time frame by part number.
- (4) Grote LED Products are subject to the terms set forth below under "Special LED Limited Warranty."
- (5) Grote ULTRA-BLUE-SEAL® Male-Pin Wire Harnesses shall be subject to a seven-year (7) limited warranty.
- (6) Grote ULTRA-BLUE-SEAL® Female-Pin (Standard) Harnesses shall be subject to a five-year (5) limited warranty.
- (7) Grote makes no warranty whatsoever with respect to bulbs and fluorescent tubes in lamp assemblies.

SPECIAL LED LIMITED WARRANTY

Grote LED lamps are covered by the Grote Special LED Limited Warranty and are warranted to be free from defects in workmanship and / or material only for the specified time frames listed below. Grote will replace any Grote LED lamp to the original purchaser if the Grote LED lamp fails due to defects in workmanship and / or materials during the warranty time frame specified below:

THE LED LIMITED WARRANTY DOES NOT APPLY TO SEVERE APPLICATIONS such as off-road vehicles or construction equipment. These applications are examples for the purpose of illustration only; these examples are not intended to, and in fact do not, constitute an exhaustive list of "severe applications."

- (1) Grote LED lamps are to REMAIN INTACT, FREE FROM PHYSICAL ABUSE, SUBJECT TO PROPER INSTALLATION WITHOUT MODIFICATION AND MUST BE USED ONLY WITH GROTE-APPROVED WIRING ACCESSORIES. ANY VIOLATION OF THESE CONDITIONS WILL VOID THIS LED LIMITED LAMP WARRANTY. For guidance regarding proper installation, please see above under "Surface Mount Installation Guidelines."
- (2) ANY DAMAGE DUE TO CHEMICALS OR INCOMPATIBLE CLEANERS WILL VOID THIS WARRANTY.
- (3) Grote LED lamps are designed to work in conjunction with the Grote ULTRA-BLUE-SEAL® trailer wiring system, including Grote factory-molded pigtailed for use with the Grote ULTRA-BLUE-SEAL® trailer wiring system. Therefore, Grote LED lamps have a Limited Warranty based on the following criteria:

A – Grote SuperNova® high-performance LED lamps are covered by a ten-year (10) Limited Warranty when installed with male-pin, hard-shell or patented double-seal pigtail connectors.

- 1) Grote SuperNova® high performance LED lamps are covered by a three-year (3) Limited Warranty when installed with hard wire bullet connectors.

B – Grote Hi Count® LED lamps (part numbers that begin with a G) are covered by a two-year (2) Limited Warranty.

C – Grote WhiteLight™ LED lamps are covered by a three-year (3) Limited Warranty.

D – Grote Select™ high-value LED lamps are covered by a two-year (2) Limited Warranty and Grote's exclusive Performance Advantage Plus Extended Warranty Program, which is three-year (3) Limited Warranty when installed with Grote ULTRA-BLUE-SEAL® patented double-seal pigtail connectors.

E – Grote LED lamps that are hard wired and use standard bullet terminal / receptacle type connections are covered by a three-year (3) Limited Warranty.

F – Grote Warning and Hazard LED's are covered by a two-year (2) Limited Warranty.

- 1) Battery Operated Warning and Hazard LED's are covered by a one-year (1) Limited Warranty

G – Other Grote LED lamps for FMVSS applications excluding SuperNova®, MicroNova®, WhiteLight™ and Hi Count® are covered by a two-year (2) Limited Warranty.

H – Other Grote LED lamps (non-FMVSS) are covered by a one-year (1) Limited Warranty.

LED Brand Category	Termination Style						
	Male-Pin	Hard-Shell	Female-Pin	Hardwire w / Bullet Connect.	Hardwire	Patented Double-Seal Pigtail	Battery Operated
Grote SuperNova®	10	10	N/A	3	N/A	10	N/A
Grote MicroNova®	N/A	N/A	N/A	3	N/A	N/A	N/A
Grote Hi Count®	N/A	N/A	2	N/A	2	N/A	N/A
Grote WhiteLight™	3	3	3	3	3	N/A	N/A
Grote Select™	N/A	N/A	2	N/A	N/A	3	N/A
Grote Warning and Hazard LEDs	2	N/A	N/A	2	2	N/A	1
Grote LEDs (FMVSS)	2	N/A	2	2	2	N/A	N/A
Grote LEDs (non-FMVSS)	N/A	N/A	N/A	1	1	N/A	1

Number represents the years of warranty from manufacture date

QUALITY SYSTEMS:

Products within the catalog may be manufactured under various quality system certifications. If a customer requires particular quality certifications on specific products, he or she may contact Grote Industries for detailed information.

END USER RESPONSIBILITY:

Each user bears full responsibility for making his or her own determination as to the suitability of Grote materials, products, recommendations, or advice for their own particular use. Each user is ultimately responsible to identify and perform tests and analyses necessary to ensure that its finished parts incorporating Grote products will be safe and suitable for use under end-user conditions. Nothing in this or any other document, nor any oral recommendation or advice, shall be deemed to alter, vary, supersede, or waive any provision of this Limited Warranty or this Disclaimer, unless any such modification is specifically agreed to in writing signed by a Grote Industries Representative.

INTELLECTUAL PROPERTY:

No statement contained herein concerning a possible or suggested use of any material, product or design is intended, or should be construed, to grant any license under any patent or other intellectual property right of Grote Industries or any of its subsidiaries or affiliates covering such use or design, or as a recommendation for the use of such material, product or design in the infringement of any patent or other intellectual property right.

The information in this catalog is deemed correct at the time of publication and is provided in good faith. There may be inaccuracies due to legislative changes, competitive part number changes, technological advances or typographical errors. Customers should contact Grote Industries for updated information.

WARRANTY RETURN AND REPLACEMENT INSTRUCTIONS

To be eligible for limited warranty consideration, either contact your Grote sales representative or call Grote customer service at 800.628.0809. (In Canada call 800.268.5612.) Upon issuance of a returned goods authorization number, return the failed product, freight prepaid to: Warranty at Grote Industries, Inc., 2600 Lanier Drive, Madison, Indiana 47250. In Canada, return product, freight prepaid to: Warranty at Grote Industries Co., 230 Travail Road, Markham, Ontario L3S 3J1. Any product covered under the terms of the respective limited warranty will be replaced directly to the original consumer / purchaser only. Items received by Grote will not be returned unless accompanied by a specific written request. The product to be returned will be those items not covered under the warranty and will be returned to sender freight collect.

CONSUMER RIGHTS IN VARIOUS STATES

This warranty gives you specific legal rights, and you may have other rights that vary from state to state. Some states do not allow limitations on how long an implied warranty lasts, so the above limitations may not apply to you. Furthermore, some states do not allow the exclusion or limitation of incidental or consequential damages so the above limitation or exclusion may not apply to you.

Effective January 1, 2009

MAXXIMA-TO-GROTE INTERCHANGE

Maxima PN	Grote Form, Fit and Function	Grote Fit and Function
M09100R	G3002	
M09100Y	G3003	
M09105R	G3092	
M09105Y	G3093	
M11201R	G1082	
M11201Y	G1083	
M11260R	G1032	
M11260Y	G1033	
M11300Y	G1033	
M11300R	G1032	
M11300RCL	G1042	
M11300WCL		60561
M11300YCL	G1043	
M20311R	G5052	
M20311Y	G5053	
M20320R	G1502	
M20320Y	G1503	
M20330R	G2102	
M20330Y	G2103	
M20350R	G1902	
M20350Y	G1903	
M20355	G1902+43783	
M20356		G1902+43780
M20357		G1902+43780
M20358		G1902+43783
M20370WCL	77461	
M20370YCL	77463	
M20391R		G2102
M20391Y		G2103
M42100R	G4002	
M42100Y	G4003	
M42120R	G4002+43253	
M42201R	G4502	
M42201Y	G4503	
M42220	G5082-5	
M42322R	54342	
M42322Y	54343	
M42323R	54342+93552	
M42324	62691	
M42326	62691+93522	
M42328R/Y	G5300	
M42332R/Y	G5530	
M42333R/Y	G5540	
M42500R		55992
M42500Y		55993
M42700R	77352	
M42700Y	77353	
M42705Y	77443	
M43253	43253	
M43253CH	43343	
M43900	67150	
M49700	94180	
M50100-B	91400	
M50102	92070	
M50103	43463	
M50105	43823	
M50300-B	92120	
M50303	43823	
M50310	43673	
M50312		43074
M50400-B	91740	
M50410	43343	
M50600-B	92420	
M50900	67090	

MAXXIMA-TO-GROTE INTERCHANGE

Maxima PN	Grote Form, Fit and Function	Grote Fit and Function
M50900-X	67090-3	
M50950	67001	
M50950-X	67001-3	
M50951	66850	
M56100R	G4002	
M63100R	G6002	
M63100Y	G6003	
M63200R	77362	
M63200Y	77363	
M63322R	54172	
M63322Y	54173	
M63323R	54172+43222	
M63323Y	54173+43222	
M63324	62751	
M63325	62751+43222	
M90061R	53442	
M90081Y	55983	
PLB-625		63561

PETERSON-TO-GROTE INTERCHANGE

Peterson PN	Grote Form, Fit and Function	Grote Fit and Function
45	43424	
320	55450	
321	55460	
326	55470	
335	56020	
337	56000	
400	60001	
408		64441
413	50232	
425	50232	
428	50872	
435	60151	
436		60011
438	60101	
440	52302	
442	50912	
445	50972	
449	71422	
459		71152
500	48072	
507	64931	
508	64561	
510		64340
511	64340	
554	44810	
557	44820	
558	44750	
559	44800	
570	44530	
571	44540	
573	44690	
574	44700	
576	44710	
577	44720	
579		44730
591	18252-5	
592		
594		18103-5
595	18103-5	
596	18153-5	

Peterson PN	Grote Form, Fit and Function	Grote Fit and Function
598	18302-5	
605	28162	
606	12111-5	
607	12272-5	
608	16032	
609		12101
615	16244	
616	16092	
617	16021	
654	28032	
655	28042	
666	26012-5	
667		26021-5
780	73040	
781	73090	
799		99880
800	18252-5	
801		
805		18302-5
810	28323-5	
815	28393-5	
820	28092-5	
821	28093-5	
822	28472-5	
823	28473-5	
830	12073	
831	12112-5	
832	12113-5	
833	12263-5	
1841	44134	
1941	44421	
2757	53833	
3132		50642
3342	53052	
3352	53020	
3372	53000	
4591	71152	
4651	41160	
4671	41200	
5109		43292
5404	82-1040	
7991		77263
10609	43673	
12607	68100	
13918	94110	
14209		43690
14218	91410	
14249	67050	
14318	91400	
14418	92070	
14609		43690
14618	92120	
15009	43970	
15010	43980	
15018	92520	
15409	43990	
15410		43783
15449	66201	
16249	67001	
16309	43690	
41021		99595
41107	68170	
41307	68130	
42109	43362	
42118	92420	
42149		67010
42409		92510

Peterson PN	Grote Form, Fit and Function	Grote Fit and Function
42609	43572	
42610	43655	
42618	91740	
42809	43272	
43149	67010	
44009	43262-5	
44015		92792
44525		91302
45171	43411	
55141	82-2161	
77709		43450
79910		67061
150091	43380	
160491		66931
160492	66930	
160493		66940
162491	66850	
162493	66851	
421491		66843
431491	67000	
10015A		90163
10015R		90162
100A		45413
100R		45412
10215A		90163
10215R		90162
1043R	49042	
104A	45413	
104R	45412	
106A	45933	
106R	45932	
10715A		92433
10715R		92432
1073R	49112	
107WA	46883	
107WR	46882	
10815A		90203
10815R		90202
108WA	46713	
108WR	46712	
10915A		90133
11015A		90303
11015B		90305-5
11015C		90301
11015R		90302
111R	49002	
117A		45993
11815A	91683	
118A	46543	
119A		45173
119R		45172
120A		46003
122A		46283
122R		46282
123A	46283	
123R	46282	
12415A	90923	
12415R	90922	
124A	46893	
124R	46892	
12625A	92693	
12625C	92691	
12625R	92692	
13025A		91043
13025R		91042
130A	46303	
130R	46302	

PETERSON-TO-GROTE INTERCHANGE

Peterson PN	Grote Form, Fit and Function	Grote Fit and Function
13415A		90123
13415R		90122
135A	45263	
135R	45262	
13615A	90153	
13615R	90152	
136-3R	49062	
136A	45253	
136R	45252	
13815A		91963
13815R		91962
138A	46793	
138R	46792	
14218K	94000	
142A	45813	
142R	45812	
14318K	94010	
143A	45833	
143FA	45833 + 43162	
143FR	45832 + 43162	
143R	45832	
145A	47013	
145R	47012	
146A	45823	
146FA	45823 + 43152	
146FR	45822 + 43152	
146R	45822	
150A	46413	
150R	46412	
15409K	43850	
15410K		43783 + 66891
154A	46743	
154C	60301	
154KA		45093
154KR		45092
154R	46742	
155A		46833
155R		46832
15625A		92163
15625R		92162
156A		46803
156R		46802
158A		47073 + 66911
158R		47072 + 66911
160A	49253	
160R	49252	
162A	47123	
162R	47122	
164A	47113	
164R	47112	
2636A		46413 + 91380 + 67050
2636R		46412 + 91380 + 67050
2637A	45093	
2637R	45092	
2668A	55573	
2668R	62171	
30625A		92763
30625C		92761
30625R		92762
3132RA	50630	
313AA	55223	
313R	55242	

Peterson PN	Grote Form, Fit and Function	Grote Fit and Function
32615A		91503
32615R		91502
338-15A		90233
338-15R		90232
352A	52513	
352R	52512	
393A		53133
394C	60361	
41015A		90013
41015C		90011
41015R		90012
41025A		90013
41025R		90012
41524V	62321	
415K	62331	
415K24V	62321 + 91740 + 67010	
416K	62251	
417KR		53312 + 91740 + 66830
417R		53312
417TA		53413
418KR		53182 + 66830
418R		53182
418SA		77353
418SR		77352
418TA		53513
420KR		53962 + 92420 + 66830
420R		53962
421AEF	55773	
421AER	55772	
421KA	52573	
421KR	52572	
421R	52892	
422R	52922+64930	
423KR		53622 + 66830
423R		53622
426A	52923	
426A24V	52153	
426AEF	55573	
426AEF24V		52153
426AER	55572	
426AER24V		52152
426KA	52783	
426KR	52782	
426R	52922	
426R24V	52152	
427KR	52682	
427R24V		
428S	50862	
428W	50852	
430L		51042
430R		51042
436SX	60011	
44015R		92792
440L	52312	
442L	50902	
461R		40352-1
461RSK	40352-1	
465K		40650-5
467K		40641-5
503HF	63151-5	
503HT	63171-5	
504HF	63181-5	
504HT	63201-5	
505K	64260-4	

Peterson PN	Grote Form, Fit and Function	Grote Fit and Function
5076V	64981	
507F		64991
507LU	64930	
508LU		64931
5406P	82-1011	
5406S	82-1016	
5407P	82-1001	
5407S	82-1002	
5515A		91153
5515R		91152
6080	12173	
608X	16033	
616W	16091	
617X	16023	
617XH	16053	
619W	16021	
653X	28083-5	
654X	28033	
655X	28043	
657C		28373-5
657X	28373-5	
666W	26001-5	
667X	26323	
746A		77103
746B		77105
746R		77012
753A	76813	
753MA	76813+43090	
754A		76223
754B	76225	
754R	76222	
755A		76223
755B		76225
755R		76222
756A	76163	
756MA	76183	
759A	76243	
759B	76245	
759R	76242	
763A	76183	
76625A	92033	
766A	77101	
7691A		77103
7691B		77105
7691C		77101
7691R		77102
769A		77103
769B		77105
769C		77101
769MA		77203
769R		77102
77415A		92453
77415B		92455
77415R		92452
775A		76823
789A		77093
789B		77095
789C		77091
789MA		77903 + 97750
789R		77092
790A		77093
790B		77095
790C		77091
790R		77092
793A		77053
793B		77055
793C		77051

PETERSON-TO-GROTE INTERCHANGE

Peterson PN	Grote Form, Fit and Function	Grote Fit and Function
793R		77052
794A1	43100	
794A2	43100	
799K		52010
812L	28433-5	
812R	28423-5	
813L	28412-5	
813R	28402-5	
814L	28413-5	
814R	28403-5	
834L		12263-5
834R		12263-5
95A		46413 + 43370
95R		46412 + 43370
96A		46413 + 43380
96R		46412 + 43380
B10015A		90163
B10015R		90162
B10609	43673-3	
B10715A		92433
B10715R		92432
B10815A		90203-3
B10815R		90202-3
B13415A		90123-3
B13415B		
B13415C		90121
B13415R		90122-3
B13815A		91963-3
B13815B		91964
B13815C		91961
B13815G		91965
B13815R		91963-3
B14217	91880-3	
B14218	91410-3	
B14249	67050-3	
B14318	91400-3	
B14418	92070-3	
B14609		43690-3
B14618	92120-3	
B15018	92520	
B160491	66930-3	
B160492	66931-3	
B160493		66940
B16249	67001-3	
B162491	66850	
B162493	66851-3	
B33415A		91583
B33415R		91582
B33815A		90233
B33815B		90235
B33815R		90232
B41015R		90012-3
B41107	68170	
B41307	68130	
B42118	92420-3	
B42149		67010
B421491		66843
B42618	91740-3	
B42809	43272-3	
B43149	67010-3	
B431491	67000-3	
B44009	43262-5	
B45	43424-3	
B460A	40193-3	

Peterson PN	Grote Form, Fit and Function	Grote Fit and Function
B460R	40192-3	
B470A	41023-3	
B470R	41022-3	
B472A	40233-3	
B472R	40232-3	
B475A	40053-3	
B475R	40052-3	
B476A	40153-3	
B476R	40152-3	
B477A	41013-3	
B477A	40093	
B477R	41012-3	
B477R	40092	
B479A	41043-3	
B479R	41042-3	
B480A	41033-3	
B480R	41032-3	
B481A		41003-3
B481R	40072	
B481R		41002-3
B486A		40153-3
B486R		40152-3
B487A	40133-3	
B487R	40132-3	
B489A		41153
B489R		41152
B490A	41143	
B490R	41142	
B491A	41153	
B491R	41152	
B5400A		82-1031
B5400B		82-1032
B5425Y	68420-3	
B560		83-2383
B570	44530-3	
B603	12004	
B603L	12014	
M100A		45413
M100R		45412
M102A	45413-3	
M102R	45412-3	
M1043R	49042-3	
M104A	45413-3	
M104R	45412-3	
M106A	45933-3	
M106R	45932-3	
M1073R	49112	
M107WA	46883-3	
M107WR	46882-3	
M108WA	46713-3	
M108WR	46712-3	
M110A	45023-3	
M110C	45021-5	
M110R	45022-3	
M114A		46393-3
M114R		46392-3
M115A		46393-3
M115R		46392-3
M118A	46543	
M119A		45173
M119R		45172
M120A	46003-3	
M120R	46002-3	
M122A		46893
M122R		46892
M122XA	46893-3	
M122XR	46892-3	

Peterson PN	Grote Form, Fit and Function	Grote Fit and Function
M124A	46893-3	
M124R	46892-3	
M126A	47053	
M126C	47051	
M126R	47052	
M130A	46303-3	
M130R	46302-3	
M133A	47263-3	
M133R	47262-3	
M135A	45263-3	
M135R	45262-3	
M136A	45253-3	
M136R	45252-3	
M138A	46793-3	
M138B		46793-3+91965-3
M138C	46791-3	
M138G		46793-3+91964-3
M138R	46792-3	
M139A	46783-3	
M139R	46782-3	
M142A	45813-3	
M142R	45812-3	
M143A	45833-3	
M143FA	45833 + 43162	
M143FR	45832 + 43162	
M143R	45832-3	
M145A	47103-3	
M145R	47102-3	
M146A	45823-3	
M146C	45821-3	
M146FA	45823 + 43152	
M146FR	45822 + 43152	
M146R	45822-3	
M150A	46413-3	
M150C	60261-3	
M150R	46412-3	
M150W	60271-3	
M152A	46413-3	
M152BKA		45083-3
M152BKR		45082-3
M152R	46412-3	
M153A	47083-3	
M153R	47082-3	
M154A	46743-3	
M154R	46742-3	
M155A		46833-3
M155R		46832-3
M156A		46803-3
M156R		46802-3
M1581A		47073-3
M1581R		47072-3
M158A	47073 + 66910	
M158R	47072 + 66910	
M160A	47243-3	
M160R	47242-3	
M161A	47093-3	
M161R	47092-3	
M162A	47123-3	
M162R	47122-3	
M163A	47233-3	
M163FA		47203
M163FR		47202
M163R	47232-3	
M164A	47113-3	
M164FA		47113 + 43152

Technical Information

Information Technique Información técnica

PETERSON-TO-GROTE INTERCHANGE

Peterson PN	Grote Form, Fit and Function	Grote Fit and Function
M164KR		47112 + 43152
M164R	47112-3	
M165A	47113-3	
M165FA	47113-3+43152-3	
M165FR	47112-3+43152-3	
M165R	47112-3	
M306A	53133	
M306R	53132	
M343A	53853-3	
M352A	52513-3	
M352KA	52543-3	
M385S	61671-3	
M387S		61371
M389S		61091-3
M390S		61161-3
M391		61491-5
M392C		62021
M393C	62291	
M394C	60361-3	
M400	60001-3	
M408		64441
M4102	50352	
M411C	60311	
M411SC	62201-3	
M413	50232-3	
M41307	68130	
M413S	52522	
M415	62271-3	
M41524V	62321	
M416	62231	
M417R		53312-3
M417R		53312-3
M417R2		52352-3
M417TA		53413-3
M418R		53182-3
M418R		53182-3
M418R2		53292-3
M418TA		53513-3
M420R		53962-3
M420R2		53962-3
M421A	52893-3	
M421HR		
M421KA		
M421KR		
M421R	52892-3	
M423R		53622-3
M423R2		53622-3
M424R	52692-3	
M425	50232-3	
M425S	52522-3	
M426A	52773-3	
M426KR	53012-3	
M426R	52772-3	
M426R24V		52152-3
M427R	52672	
M428	50872-3	
M428S	50862-3	
M428W	50852-3	
M433S		61221-3
M434	61501	
M435	60151	
M436	60001	
M436B	60081	
M437	60251	

Peterson PN	Grote Form, Fit and Function	Grote Fit and Function
M439		60001
M440	52302-3	
M440L	52312-3	
M441	52302	
M441L	52312	
M452	52442	
M452L	52452	
M456L	52482	
M456L	52492	
M504HF	63181-5	
M504HT	63201-5	
M507	64931	
M508	64561	
M517		64201
M525		64721
M525S		64161-5
M526		64181-5
M540		68420-3
M544	65420-5	
M545	68420-3	
V102A	45413-5	
V102R	45412-5	
V10609	43673-5	
V10715A		92433
V10715R		92432
V1073R	49112-5	
V1076A	65093-5	
V1076R	65092-5	
V107WA	46883-5	
V107WR	46882-5	
V10815A		90203-5
V10815R		90202-5
V108WA	46713-5	
V108WR	46712-5	
V109A		45333
V11015A		90303
V11015B		90305-5
V11015R		90302-5
V110A	45023-5	
V110R	45022-5	
V114A		46393-5
V114R		46392-5
V118A	46543-5	
V118KA		46543-5
V120A		46003
V122XA	46893-5	
V122XR	46892-5	
V126A	47053	
V126C	47051	
V126R	47052	
V128A	45933-5	
V128R	45932-5	
V131A	454135	
V131R	454125	
V132A	46983-5	
V132R	46982-5	
V133XA		47263
V133XR		47262
V13415A		90123-5
V13415R		90122-5
V135A	45263	
V135R	45262	
V136A	45253-5	
V136R	45253-5	
V13815A		91963-5
V13815R		91962-5
V138A	46793-5	
V138R	46792-5	

Peterson PN	Grote Form, Fit and Function	Grote Fit and Function
V139A	46783	
V139R	46782	
V142A	45813-5	
V142R	45812-5	
V143A	45833	
V143R	45832	
V146A	45823-5	
V146R	45822-5	
V150A	46413-5	
V150KA	46422-5	
V150KR	46423-5	
V150R	46412-5	
V153KA	47083 + 43980 + 67001	
V153KR	47082 + 43980 + 67001	
V158KA	47073 + 66910	
V158KR	47072 + 66910	
V160KA	47243 + 66930	
V160KR	47242 + 66930	
V161KA	65203	
V161KR	65202	
V162KA	47123 + 91400 + 67001	
V162KR	47122 + 91400 + 67001	
V164KA	47113 + 92120 + 67001	
V164KR	47112 + 92120 + 67001	
V306A	53133	
V306R	53132	
V3132		50642-5
V3132RA	50630	
V313AA	55223	
V313R	55242	
V3342	53052	
V3352	53020	
V3372	53000	
V3392	50652	
V384	61641	
V384S	61651	
V385S	61671	
V390S		61161
V391C	61491-5	
V392C		62021-5
V408		64441
V41015R		90762
V4102	50352	
V410R	50352	
V413	50232-5	
V417KR	53312 + 91740 + 66830	
V417KR2	53252 + 91740 + 66830	
V417KTA	53413 + 91740 + 66830	
V418KR	53182+66830	
V418KR2	53292 + 66830	
V418KTA	53513 + 66830	
V420KR	53962 + 92420 + 66830	
V420KR2	53962 + 92420 + 66830	
V421KR	52572	
V421R	52892-5	
V423KR	53622 + 66830	
V423KR2	53622 + 66830	
V426KR		52782

PETERSON-TO-GROTE INTERCHANGE

Peterson PN	Grote Form, Fit and Function	Grote Fit and Function
V426R	52772-5	
V428	50872-5	
V42809	43272-5	
V428S	50862-5	
V428W	50852-5	
V434	61501	
V435	60151	
V436SX	60011-5	
V438	60101-5	
V440	52302-5	
V44009	43262-5	
V44015		92792
V440L	52312-5	
V445	50972-5	
V452		51932
V452L		51933
V472A	40233-5	
V472R	40232-5	
V472R	40232	
V475A	40053-5	
V475A	40053	
V475R	40052-5	
V475R	40052	
V480A	41033-5	
V480R	41032-5	
V483A		40303
V483R		40302
V487A	40133	
V487R	40132	
V500		48072
V507	64931-5	
V5152	64003-5	
V5172	64061-5	
V5182		64401-5
V5192	64093-5	
V52009	43870-5	
V52010	68460-5	
V52040	44840-5	
V52041	44870-5	
V5262		63511-5
V5271	64213-5	
V5291		64301-5
V530	64481-5	
V5302		64481-5
V531	64501-5	
V5312		64501-5
V5322		64581-5
V537	64141	
V538	64591	
V539	64131	
V540	65370-5	
V5400A		82-1031
V5400B		82-1032
V5404	82-1040	
V5425Y	68540-5	
V543	65312-5	
V544	65440-5	
V547	65330-5	
V5522	64003-5	
V555		65402-4
V5572	64301-5	
V5592	64631-5	
V560	84-2383	
V5621		63511-5

Peterson PN	Grote Form, Fit and Function	Grote Fit and Function
V5631	64311-5	
V5641		64631-5
V5651	64581-5	
V5661	64061-5	
V5671	64351-5	
V5681	64401-5	
V570	44530-5	
V580	64171	
V5822	64371-5	
V5832	64631-5	
V5862	64381-5	
V599	12312-5	
V600	12201-5	
V602	12164-5	
V603	12004-5	
V603L	12014-5	
V766MA	77203	
V771A		76183
V771B		76185
V771R		76182
V773A		76083
V774A	76033	
V774B	76035	
V774R	76032	
V808	10083-5	
V809		28032
V809F		28162
V809X		28033
VH549	92701-5	
VH550	90861-5	
VH551	90971-5	

TRUCK-LITE-TO-GROTE INTERCHANGE

Truck-Lite PN	Grote Form, Fit and Function	Grote Fit and Function
32		40302
37	41160	
41	40232	
43	40192	
45		40072
47		40152
50	43411	
52		40092
54	41032	
57	40152	
102	44170.00	
131		82-2151
132	82-2116	
172	44530	
173	44540	
182	44690	
183	44700	
191	44460	
262	44810	
263	44820	
264	44893	
266	44730	
270	44020	
275	44010	
276	44030	
282	44710	
283	44720	
285	44891	
318	43090	43610
319	43090	43420
333		76032

Truck-Lite PN	Grote Form, Fit and Function	Grote Fit and Function
387	76121	
528	52492	
529	52482	
541	50862	
542		50852
544		50862
548	53132	
550	44320	
552	44310	
552	44310	
00790		43970
00791	94233	
00793	43980	
797	71152	
798	71422	
00801	42180	
00802		43970+67050
00808		49172
00815	49122	
1050	G1032	
1051	G1042	
1052	45832	
1075	G1082	
1150	46322	
1155	G5052	
1203	46782	
1204		46782+43673
1211		46792
1213	46792	
1215	49082	
1216		49082
1222	46712	
1259	45262	
1264	45932	
1501	45412	
1507	46882	
1520	45512	
1555	45672	
1560	G1502	
1570	46982-5	
1571	47052	
1960	G1902	
2110		50882
2112	50882	
2150	G2102	
2660	G4602	
2701	56052	
2702	53052	
2750	G5300	
2752	G5543-5	
2753	G5530-5	
2756	G5540-5	
2801	56020	
2803	53020	
3050	G3002	
3075	G3092	
3616	52612	
3701		56052
3702		53052
3763	53032	
3802	56000	
3812	53000	
3850		55220
4013	50912	
4014	50902	
4015	50952	
4016	50942	

Technical Information

Information Technique Información técnica

TRUCK-LITE-TO-GROTE INTERCHANGE

Truck-Lite PN	Grote Form, Fit and Function	Grote Fit and Function
4017	50952	
4018	50942	
4023	52912	
4024	52902	
4025	52812	
4026	52802	
4027	50972	
4028	50992	
4050	G4002	
4051	G4022	
4091		52063
4094		52062+66905
4550	G4502	
4742	55410	
4754	55420	
4805	55470	
4854	55430	
4855	55440	
5013	53712	
5014	53702	
6050	G6002	
6051	G6012	
6500	78322	
6502	50132	
6503	56072	
7038	12201-5	
7039	12004	
7044	12014	
7048	12164	
7217	28393-5	
7218	28393-5	
7223	12263-5	
7224	12263-5	
7225	29423	
7226	29433	
7268		122635-5
7269	12263-5	
7518	28423-5	
7519	28433-5	
7555		28473-5
7557	28473-5	
7575	28373-5	
7576	28402-5	
7577	28403-5	
7596	28882-5	
7597	28872-5	
7598	28862-5	
7599	28852-5	
7618	18302-5	
7619		18302-5
8810	92980	
8820	92970	
9101	68110	
9102	68170	
9103	68170	
9105	68110	
9107	68110	
9160	68080	
9162	68080	
9179	43673	
9180	94110	
9199	43112	
9288	43482	
9291	43872	

Truck-Lite PN	Grote Form, Fit and Function	Grote Fit and Function
9296		43112
9464	68680	
9465		66826
9470		68680
9702	43090	
10400		42180
10401	94010	
10402	65520	
10403		91880
10404	94000	
10410	43430	
10412	91890+67050	
10414	93750+67050	
10700	91400	
10702	92070	
10704	91410	
10708	91880	
10713	91400	
10714	92070	
10718		92070
10720		42180
10722	91890	
10725	93750	
10728		42180
10729	43512	
10730	43522	
10731		42180
10732	49140	
10738	43760	
14700		
14701	93402	
15011	60460	
15012		60460
15013		60460
15040	65790	
15041		65790
15042		01-6061-70
15043		01-6061-70
15053	65790	
15054	65790	
15055		65790
15058		65790
15059		65790
15060		65790
15205	60601	
15208		60261
15226	60601	
15227	60601	
15401	43380	
15404	43970	
15405	43980	
15406	43970	
15407	43980	
15408		43970
15409	43980	
15412	43370	
15413	43370	
15414	43370	
15415		46740
15416		46740
15417		46740
15418		46740
15702	91380	
15720		43380
15727	43370	
15728	43380	
15729	43380	

Truck-Lite PN	Grote Form, Fit and Function	Grote Fit and Function
15730	43380	
15733	43370	
15736	42162	
19206	60291	
19720	43780	
19721	43850	
19723		43120
19724	43120	
19726		43850
19729		43850
19736		43120
19739		43850
19740		43850
19748	43783	
30400		42180
30401	92120	
30402	92150	
30403		42180
30404	93760	
30405	93760	
30407	93760	
30410		43690
30700	92120	
30701	92120	
30702	92120	
30704	92150	
30711		92120
30720		42180
30721	43690	
30722	43690	
30727	43690	
30728	43532	
30729		93760
30730		43690
30731		43690
33710	42110	
33711		42110
35720	43230	
40003	61431	
40004	62181	
40011	62720 + 91740 + 67010	
40012	62321 + 91740 + 67010	
40023	61451 + 92511 + 67010	
40044	62221	
40071	62221 + 92512 + 67013	
40084	62221	
40203	61051	
40204	62271	
40211	62720	
40212	62321	
40223	61451+92511	
40224	62271+92511	
40227	61451	
40244	62211	
40260	62211+92512	
40261	62211+92511	
40262	62271+92512	
40403	67150	
40626	51032	
40627	51022	
40637	51032	
40638	51022	
40700	91740	

TRUCK-LITE-TO-GROTE INTERCHANGE

Truck-Lite PN	Grote Form, Fit and Function	Grote Fit and Function
40701		91740
40715	43462	
40719	43572	
40720	43572+92512	
40721		51052
40722		51052
40725	51090	
40726	43572+92512	
40742		51052
40743		51052
40746		51052
40747		51052
40756	51052	
40757	51052	
40819	91740	
40844	62421	
40850	50830	
42722	43022	
44705	43343	
44708		43343
44709		43343
44710		91740
45004		62381
45024		62381
45204		62381
45700	94180	
45701	91480	
45720		43212
45721	43212	
50100		82-5604
50878	87140	
50879	87150	
60403	67151	
60700	92420	
60701	92420	
60704	92720	
60708		92420
60709		92720
60720	43362+43222	
60722	43362	
60723		43362+43222
60724		43362
60728		43362
60729		43362
60730	43362	
60731	43100	
60733	43952	
70300	55232	
70311	50630	
77825	84-9449	
80201		64123
80202		64111
80203		64411
80204		63161-5
80205		63151-5
80206		63171-5
80207		63151-5
80208		63151-5
80209		63171-5
80304	62331	
80340	62021	
80342		62151
80344	62201	
80345	62151	

Truck-Lite PN	Grote Form, Fit and Function	Grote Fit and Function
80350	61821	
80351	61831	
80352	61821	
80353	61831	
80360	64931	
80361	64561	
80364	64441	
80368	64123	
80374		64111
80375	64931	
80388	63171-5	
80389	63171-5	
80394	63171-5	
80395	63151-5	
80396	63151-5	
80397	63161-5	
80418	61511	
80427		61161
80438	64561	
80444	61371	
80482	61161	
80490	61031	
80491	64901	
80492	64901	
80493	64141	
80500	64311-5	
80510	64401-5	
80511	64531-5	
80512	64213-5	
80513	64401-5	
80514	64531-5	
80515	64401-5	
80516	64531-5	
80517	64581-5	
80519	64213-5	
80520		63481 (x2) +68460-5
80525		64581-5
80526	64851-5	
80527	64581-5	
80560	92701-5	
80563	90861-5	
80564	90900	
80565	99780-5	
80574	44870-5	
80589	63481	
80593	68460-5	
80594	44870-5	
80595	43872	
80596	42-9003-HWB	
80597	42-9004-HWB	
80598	42-9005-HWB	
80599	42-9006-HWB	
80600	42-9007-HWB	
80720	43262-5	
80800	64261-4	
80805	63451-4	
80810	64241	
80820	64251	
80830	68680	
80831	68680	
80839	68680	
80848	63381	
80849	63391	
80888	63441-4	
80893		63451-4
81331	55470	

Truck-Lite PN	Grote Form, Fit and Function	Grote Fit and Function
81360		63561
81371		63561
81374		63561
81380	63551	N/A
92100		53582
92101		53582
92560	77013	
92702	99850	
92716	44740	
92900	73040	
92901	73040	
92902	73110	
92903		73030
92904		73030
92905		73080
92907	44421	
92909	73190	
92910		73040
92911		73110
92914	73230	
92916	73220	
92918		73230
92921	73180	
92922	73190	
92923	73080	
92924	73090	
92925	44421	
92926	73200	
92927	73030	
94609	66930	
94706	66860	
94707	66861	
94718		66931
94727	66981	
94729	66981	
94736	66931	
94759	66862	
94766	66861	
94782	66932	
94789	66860	
94802		67090
94882		67090
94902	67001	
94909	67001	
94916	67001	
94919	67001	
94920	67001	
94923	66190	
94924	67001	
94925	67010	
94926	67000	
94937	84-1000	
94938	84-1000	
94940	68380	
94961	67011	
94964	66840	
94972	66801	
94991	67014	
94992	67014	
94993	67090	
95001	66860	
95051	66200	
95220	66861	
95306	66931	
95400	84-1039	
95410	66931	
95424		66861

Technical Information

Information Technique Información técnica

TRUCK-LITE-TO-GROTE INTERCHANGE

Truck-Lite PN	Grote Form, Fit and Function	Grote Fit and Function
96106	66911	
96107	67002	
96108	66842	
96930	66360	
96932		66360
96934		66360
96935		66360
96936		66360
97002	99502	
97003	44421	
97005	66931	
97006	66931	
97017	00460	
97018	00470	
97020	00180	
97100	87890	
97101	87891	
97127	00931	
97128	99080	
97137	00830	
97151	87110	
97153	87111	
97160	87100	
97161	87101	
97171	00840+00841	
97172	00840+00842	
97173	00840+00843	
97174	00840+00844	
97175	00840+00845	
97176	00840+00846	
97201	44010	
97231	44010	
97235	44030	
97252	HELP	
97254	44080	
97270	44010	
97272	44030	
97283	44090	
97300	44040	
97302	44060	
97360	72010-5	
97361	72050-5	
97362	72100-5	
97363	72110-5	
97384	28763	
97602	12073	
97603	12072	
97606		12272-5
97609		12020
97610		12020
97611	28032	
97612	28031	
97614	12813	
97615		12813
97618	28033	
97619	28032	
97620	28031	
97621	28043	
97622	28042	
97623	28041	
97624	16284	
97625	16294	
97626	16304	
97627	16244	

Truck-Lite PN	Grote Form, Fit and Function	Grote Fit and Function
97628		16244
97629		16244
97632	16043	
97634	16043	
97635	16043	
97636	16142	
97637		16273
97638	16273	
97639	16153	
97649	16092	
97651	16102	
97653	12073	
97654	12072	
97655	12113-5	
97656	28763	
97659	12263-5	
97660	12111-5	
97664		28481
97665	28481	
97666	22002	
97667	28493	
97668		28453
97669	28451	
97678	28093-5	
97680	28091-5	
97681	28323-5	
97682	28323-5	
97686	28443	
97688	28491	
97693	16123+22013	
97695		22013+22233
97718	11303	
97719	10012	
97720	10002	
97721		10012
97722	10002	
97725	22233	
97726	22232	
97730	10083	
97731	10045	
97732	10113	
97733	11293	
97748	10623	
97750	28473-5	
97794	12193-5	
97799	93351	
97800	12263-5	
97802	28032	
97803	16033	
97804	16032	
97805	12111-5	
97806	16091	
97807	12071	
97808	16101	
97809	16053	
97811	16092	
97812	16023	
97814	12173	
97815	16033	
97816	16032	
97817	12173	
97818	16102	
97819	28033	
97820	28032	
97821	28031	
97822	16123	
97823	10173	
97827	16223	

Truck-Lite PN	Grote Form, Fit and Function	Grote Fit and Function
97828	10433	
97829	22193	
97831	12272-5	
97835	12020	
97836	16123	
97837	16053	
97840	97840	
97843	22013	
97845	29060	
97846	28453	
97849	10173	
97850	28293-5	
97852	28093-5	
97860	16023	
97861	16273	
97862	28493	
97863	12010	
97865	28763	
97866	16153	
97869	16023	
97872	28033	
97912	84-3006	
97940	99180	
97944	99170	
97955	66080	
97956	84-4004	
97960	43901	
97980	64930	
98013	99170	
98100	40641	
98101	40650	
98107	41080	
98110	41133	
98126	40641	
98127	41050	
98131	40980	
98132	40970	
98134	40980	
98136	40650-5	
98142	40980	
98146	41210	
98153	41121	
98155		41121
98165	41133	
98168	41133	
10004R		42180+67050
10004R3		42180-3 + 67050-3
10004RP		42180-3 + 67050-3
10004Y		45812 + 42180 + 67050
1001AD		45023-5
1001D		45022-5
10028R	45072	
10028R1		45072
10028Y	45073	
10028Y1		45073
10050R	47472	
10050R1		47472
10050R3	47472-3	
10050Y	47123	
10050Y1		47473
10050Y3	47473-3	
10051R		47472
10051R1		47472
10051R3		47472-3
10051Y		47473

TRUCK-LITE-TO-GROTE INTERCHANGE

Truck-Lite PN	Grote Form, Fit and Function	Grote Fit and Function
10051Y1		47473
10051Y3		47473-3
10075R		G1032 + 91400 + 66850
10075R3		G1032-3 + 91400-3 + 66850-3
10075Y		G1033 + 91400 + 66850
10075Y3		G1033-3 + 91400-3 + 66850-3
10076R		46142 + 91400 + 66850
10076R1		46142 + 91400 + 66850
10076Y		46143 + 91400 + 66850
10076Y1		46143 + 91400 + 66850
10079R		47122 + 43160 + 66850
10079Y		47123 + 43160 + 66850
10085R	47242	
10085R1		47242
10085Y	47243.00	
10085Y1		47243
10086R		46142 + 91400 + 66850
10086Y		46143 + 91400 + 66850
10089R		46142 + 43160 + 66850
10089Y		46143 + 43160 + 66850
10090R		47122 + 43160 + 66850
10090R1		47122 + 43160 + 66850
10090Y		47123 + 43160 + 66850
10090Y1		47123 + 43160 + 66850
10091R		46142 + 43160 + 66850
10091Y		46143 + 43160 + 66850
10092R		46142 + 43160 + 66850
10092Y		46143 + 43160 + 66850
10202C	45811	
10202C3	45811-3	
10202MB	45812-1+45813-1	
10202R	45812	
10202R1	45812-5	
10202R3	45812-3	
10202Y	45813	
10202Y1	45813-5	
10202Y3	45813-3	
10203B	45025-5	
10203R	45322	
10203Y	45323	
10204R	45182	
10204Y	45183	
10205R	45832	

Truck-Lite PN	Grote Form, Fit and Function	Grote Fit and Function
10205R1		45832
10205R3	45832-3	
10205Y	45833	
10205Y1		45833
10205Y3	45833-3	
10208R	45832	
10208R3	45832-3	
10208Y	45833	
10208Y3	45833-3	
10209C	45811	
10209C3	45811-3	
10212Y	78343	
102-3	44170-3	
10250R	47122	
10250R3	47122-3	
10250Y	47123	
10250Y3	47123-3	
10251R	47122 + 43160	
10251R3	47122-3+43160-3	
10251Y	47123+43160	
10251Y3	47123-3+43160-3	
10276R	G1082	
10276Y	G1083	
10276Y1	G1083-5	
10286R	G1002	
10286Y	G1003	
10288R	G1002+43162	
10288R3	G1002-3+43162-3	
10288Y	G1003+43162	
10288Y3	G1003-3+43162-3	
10289R	G1002+43160	
10289Y	G1003+43160	
10375R	47122	
10375Y	47123	
10379R		47122+43160
10379Y		47123+43160
10385R	46142	
10385Y	46143	
10389R		46142+43160
10389Y		46143+43160
10391R		46142+43162
10391Y		46143+43162
10401-3	94100-3	
1050-3	G1032-3	
1050A	G1033	
1050A-3	G1033-3	
1051-3	G1043-3	
10519R	45042	
10519R1		45042
10519Y	45043	
10519Y1		45043
1051A	G1043	
1051A-3	G1043-3	
10520R	45812+93750	
10520Y	45813+93750	
1052-3	45832-3	
10525R	45072	
10525R1		45072
10525Y	45073	
10525Y1		45073
1052A	45833	
1052A-3	45833-3	
10700-3	92120-3	
10702-3	92150-3	
10704-3	91410-3	
10729-3	43512-3	
10744R	49142	

Truck-Lite PN	Grote Form, Fit and Function	Grote Fit and Function
10744R3	49142-3	
1075-3	G1082-3	
1075A	G1083	
1075A-3	G1083-3	
1150-3	46322-3	
1150A	46323	
1150A-3	46323-3	
1155-3	G5052-3	
1155A	G5053	
1155A-3	G5053-3	
1203-3	46782-3	
1203A	46783	
1203A-3	46783-3	
1204A	46783+43673	
1211-3	46792-3	
1211A	46793	
1211A-3	46793-3	
1211AD	46793-5	
1211D	46792-5	
1211W	46791	
1213A	46793	
1216A	49073	
12200R	46092	
12200R3	46092-3	
12200Y	46093	
12200Y3	46093-3	
1222A	45933	
1259-3	45262-3	
1259A	45263	
1259A-3	45263-3	
1259AD	45263-5	
1259D	45262-5	
1264-3	45932-3	
1264A	45933	
1264A-3	45933-3	
1264AD	45933-5	
1264D	45932-5	
1312A	45333	
1312A-3	45333-3	
1313A	46003	
1320A	45543	
1320A-3	46543-3	
1320AD	46543-5	
1350A		45333
1365A	46003	
14200R	45232	
14200Y	45233	
14700-3	93400-3	
15006R	46412+43370	
15006Y	46413+43370	
15008R		46412+43370
15008Y		46413+43370
15011-1		60261+43960
15011-3	60261-3+43960-3	
15013-1		60261+43960
1501A		
15033R	G1502	
15033R1	G1502-5	
15033Y	G1503	
15033Y1	G1503-5	
15040-1		65790
15040-3	65790-3	
15041-1		65790
15050R	49182	
15055-1		49182
1506-3		45252-3
1506A		45253

Technical Information

Information Technique Información técnica

TRUCK-LITE-TO-GROTE INTERCHANGE

Truck-Lite PN	Grote Form, Fit and Function	Grote Fit and Function
1506A-3		45253-3
1506AD		45253-5
1506D		45252-5
1507A	46883	
1507AD	46883-5	
1507D	46882-5	
1508R	49112	
15200C	60271	
15200C3	60271-3	
15200R	46412	
15200R1	46412-5	
15200R3	46412-3	
15200Y	46413	
15200Y1	46413-5	
15200Y3	46413-3	
15201R	45162	
15201Y	45163	
1520-3	45512-3	
15205-3	65790-3	
15208-3	60271	
1520A	45513	
1520AD	45513-5	
1520AHT	45523	
1520D	45512-5	
1520HT	45522	
15250R	47082	
15250R3	47082-3	
15250Y	47083	
15250Y3	47083-3	
15401-3	43380-3	
15506R	47872-5	
15506R1	47872-5	
15506Y	47873-5	
15506Y1	47873-5	
15507R	47872-5	
15507Y	47873-5	
1555A	45253	
1560-3	G1502-3	
1560A	G1503	
1560A-3	G1503-3	
1570A	91113	
1571A	47053	
1571AD		47053
1571D	47052	
15741R		49172
15741R3		49173-3
15745R	49172	
15745Y	49173	
172-3	44530-3	
18050R	47732	
18050R3	47732-3	
18050Y	47733	
18050Y3	47733-3	
18090R	47732	
18090Y	47733	
18300R	47732	
18300R1		47732
18300Y	47733	
18300Y1		47733
18DB	41180	
19002R	45092	
19002R1		45092
19002R3	45092-3	
19002Y	45093	

Truck-Lite PN	Grote Form, Fit and Function	Grote Fit and Function
19002Y1		45093
19002Y3	45093-3	
19006R	G1902+43850	
19006R1		G1902-5+43850
19006Y	G1903+43850	
19006Y1		G1903-5+43850
19009R		45092
19009R1		45092
19009Y		45093
19009Y1		45093
19020R	G1902	
19020Y	G1903	
19031R		65202
19031R1		65202
19031Y		65203
19031Y1		65203
19032R	47092	
19032Y	47093	
19036R		65202
19036R1		65202
19036Y		65203
19036Y1		65203
19037R	65202-3	
19037Y	65203-3	
19200C	60301	
19200R	46742	
19200R1	46742-5	
19200R3	46742-3	
19200Y	46743	
19200Y1	46743-5	
19200Y3	46743-3	
19205Y	78393	
19206-3	60291-3	
19250R	G1902	
19250R3	G1902-3	
19250Y	G1903	
19250Y3	G1930-3	
19275R		47492
19275Y		47493
19350R		47492
19350Y		47493
19375R	47492	
19375Y	47493	
1960-3	G1902-3	
1960A	G1903	
1960A-3	G1903-3	
19680A	78473	
19721-3	43850-3	
19739-3		43850-3
21001R	46072	
21001R1		46072
21001R3	46072-3	
21001Y	46073	
21001Y1		46073
21001Y3	46073-3	
21002R	46072	
21002R1		46072
21002R3	46072-3	
21002Y	46073	
21002Y1		46073
21002Y3	46073-3	
21004C	60031	
21005R	46342	
21005Y	46343	
21051R	47072	
21051R1		47072
21051Y	47073	

Truck-Lite PN	Grote Form, Fit and Function	Grote Fit and Function
21051Y1		47073
21056R	47352	
21056Y	47353	
21075R	47032	
21075R1		47032
21075Y	47033	
21075Y1		47033
21080R	47072	
21080Y	47073	
21090Y	47073	
21091Y	47073	
21092Y	47073	
21093Y	47073	
21094Y	47073	
21095Y	47073	
21096Y	47073	
21200R	46832	
21200R3	46832-3	
21200Y	46833	
21200Y3	46833-3	
21201R	46872	
21201R3	46872-3	
21201Y	46873	
21201Y3	46873-3	
21204C	60331	
21210Y	78363	
21251R	47072	
21251R3	47072-3	
21251Y	47073	
21251Y3	47073-3	
21256R	47352	
21256Y	47353	
21271R	54002	
21275R	47162	
21275Y	47163	
21501R	46832	
21501R3	46832-3	
21501Y	46833	
21501Y3	46833-3	
2150-3	G2102-3	
21506R	46832+66910	
21506Y	46833+66910	
21507R	46872+66910	
21507Y	46872+66910	
2150A	G2103	
2150A-3	G2103-3	
21880R	47072	
21880Y	47073	
22002Y	53063	
22002Y3	53063-3	
22004Y		53063
22004Y3		53063
22006R		54012
22006Y		53063
22006Y3		53063-3
22016Y		53163
22202Y	53063	
22202Y3	53063-3	
25062Y		46003
25750Y	47063	
25760Y		46543
25762Y	46003	
25765Y	46913	
25784Y	46913	
262-3	44810-3	
26250R	47262	
26250Y	47263	

TRUCK-LITE-TO-GROTE INTERCHANGE

Truck-Lite PN	Grote Form, Fit and Function	Grote Fit and Function
26251R		47262
26251R1		47262
26251Y		47263
26251Y1		47263
262D		44810
26311R	46282	
26311Y	46283	
26315R	45012	
26315R3	45012-3	
26315Y	45013	
26315Y3	45013-3	
263-3	44820-3	
26331-1	60101-5	
26331-3	60101-3	
26335-1		60011-5
26335-3	60001-3	
26336-1	60251-5	
26353R	46332	
26353Y	46333	
26354R	46322	
26354Y	46333	
26393C	60361	
26394C	60361	
2660-3	G4602-3	
2660A	G4603	
2660A-3	G4603-3	
26741R	49002	
26760Y	45993	
26760Y3	45993-3	
26762Y	92773	
26765Y	46453	
26765Y1	46453-5	
26765Y3	46453-3	
26771R	46322	
26771R3	46322-3	
26771Y	46323	
26771Y1		46323
26771Y3	46323-3	
26900R	45262	
26900Y	45263	
26901R	45262	
26901Y	45263	
26902R	45262	
26902Y	45263	
2701A	56053	
2702A	53053	
270-3	44010	
2750-3	G5300-3	
2752-3		G5543-5
2753-3		G5530-5
2756-3		G5540-5
29002R	46832+66910	
29002Y	46833+66910	
29003R	46872	
29003Y	46873	
29004C	60031	
29202R	46832	
29202R3	46832-3	
29202Y	46833	
29202Y3	46833-3	
29203R	46872	
29203R3	46872-3	
29203Y	46873	
29203Y3	46873-3	

Truck-Lite PN	Grote Form, Fit and Function	Grote Fit and Function
29204C	60331	
29204C3	60331-3	
30001R	45822+42180	
30001Y	45823+42180	
30070R	65282	
30070Y	47113 + 92120 + 67050	
30071R	47112 + 43690 + 67050	
30071Y	47113 + 43690 + 67050	
30075R		46132 + 92120 + 67050
30075Y		46133 + 92120 + 67050
30080R		46132 + 43150 + 67050
30080Y		46133 + 43150 + 67050
30085R		46132 + 92120 + 67050
30085Y		47133 + 92120 + 67050
30086R	65282	
30086R1		65282
30086Y	47113 + 92120 + 67050	
30090R	46132 + 42180 + 67050	
30090R1		46132 + 42180 + 67050
30090Y	46133 + 42180 + 67050	
30090Y1		46133 + 42180 + 67050
30091R	G3002 + 43150 + 67050	
30091Y	G3003 + 43150 + 67050	
30200C	45821	
30200C3	45821-3	
30200R	45822	
30200R1	45822-5	
30200R3	45822-3	
30200Y	45823	
30200Y1	45823-5	
30200Y3	45823-3	
30201R	47102	
30201R3	47102-3	
30201Y	47103	
30201Y3	47103-3	
30203Y		47102
30204R	45822+43690	
30204Y	45823+43690	
30206R	45202	
30206Y	45203	
30221R	45562	
30221R3	45562-3	
30221Y	45563	
30221Y3	45563-3	
30222R	45822+42180	
30222R3	45822-3 + 42180-3	
30222Y	45823 + 42180	
30222Y3	45823-3 + 42180-3	
30230Y	48333	
30257Y	78333	

Truck-Lite PN	Grote Form, Fit and Function	Grote Fit and Function
30257Y3	78333-3	
30264Y	78433	
30269Y	78433+43150	
30270R	47112	
30270Y	47113	
30271Y	78433	
30272R	47112+43150	
30272Y	47113+43150	
30275R	46132	
30275R3	46132-3	
30275Y	46132	
30275Y3	46132-3	
30276R	47212	
30276Y	47213	
30279R	42132 + 42180 + 67050	
30279Y	42133 + 42180 + 67050	
30285R	G3002	
30285R3	G3002-3	
30285Y	G3003	
30285Y3	G3003-3	
30288R	G3002 + 43152 + 67050	
30288Y	G3003 + 43152 + 67050	
30289R	G3002 + 43152 + 67050	
30289Y	G3003 + 43152 + 67050	
30375R	46132	
30375Y	46133	
30379R	46132 + 43150 + 67050	
30379Y	46133 + 43150 + 67050	
30385R	47112	
30385Y	47113	
30386R	47112 + 43150 + 67050	
30386Y	47113 + 43150 + 67050	
30401-3	65282	
3050-3	G3002-3	
30503R	45062	
30503R1		45062
30503Y	45063	
30503Y1		45063
30504R	45562	
30504R1		45562
30504Y	45563	
30504Y1		45563
3050A	G3003	
3050A-3	G3003-3	
30700-3	92120-3	
30729-3	93760-3	
3075-3	G3092-3	
3075A	G3093	
3075A-3	G3093-3	
307A	77103	
313A	77203	
328D	73140-5	
32A		40303
33050R		47962
33050R3		47962-3
33050Y		47963
33050Y3		47963-3
33051R		47952

Technical Information

Information Technique Información técnica

TRUCK-LITE-TO-GROTE INTERCHANGE

Truck-Lite PN	Grote Form, Fit and Function	Grote Fit and Function
33051Y		47953
33250R		49202
33250R3		49202
33250Y		49203
33250Y3		49203
333A	76033	
333AD	76033	
333B	76035	
333G	76034	
35001R	65512	
35001R1		65512
35001R3	65512-3	
35001Y	65513	
35001Y1		65513
35001Y3	65513-3	
35075R	47462	
35075Y	47463	
35080R	47242	
35080Y	47243	
35200R	47242	
35200R3	47242-3	
35200Y	47243	
35200Y3	47243-3	
35375R	47462	
35375Y	47463	
35720-1		43230
35740R	49212-5	
35880R	47242	
35880Y	47243	
3613W	60311	
3691W	60311	
3693W	60311	
3711B	50652-3	
37-3	41160-3	
3753AD		55243
3753D		55242
3754D	50642-5	
3755A		55243
3755D		55243
3756D		55242
3850AA		55223
3850D		55223-5
40001R	52772	
40001Y	52773	
40002R	52782	
40002R1		52782
40002R3	52782-3	
40002Y	52783	
40002Y1		52783
40002Y3	52783-3	
40003-3	61451-3	
40004-1		62451
40004-3	62451-3	
40006R	53100 + 91740 + 67002	
40008R	65292	
40008Y	52153 + 91740 + 67000	
40009R		65292
40009R3		65292-3
40009Y		52153 + 91740 + 67000
40009Y3		52153-3 + 91740-3 + 67000-3

Truck-Lite PN	Grote Form, Fit and Function	Grote Fit and Function
40015R	52672	
40015R3	52672-3	
40022R	52772 + 92511 + 67000	
40022R3	52772-3 + 92511-3 + 67000-3	
40022Y	52773-3 + 92511-3 + 67000-3	
40023-3	61451-3 + 92511-3 + 67000-3	
40028R	53012	
40028R1	53012-5	
40028R3	53012-3	
40028Y	53013-5	
40028Y3	53013-3	
40029R	53612	
40029R3	53612-3	
40029Y	52923 + 91740 + 67000	
40029Y3	52923-3 + 91740-3 + 67000-3	
40041Y	52783	
40042R	52782	
40042R3	52782-3	
40042Y	52783	
40044-3	52783-3	
40048R	52682	
40048R3	52682-3	
40058R	53612	
40098R	52952 + 91740 + 67000	
40098Y	52953 + 91740 + 67000	
40201R	52772	
40201R3	52772-3	
40201Y	52773	
40201Y3	52773-3	
40202R	52772	
40202R1	52772-5	
40202R3	52772-3	
40202Y	52773	
40202Y3	52773-3	
40203-3	61051-3	
40204-3	62431-3	
40205R	55712	
40206C		61051
40206C3		61501-3
40206R	52770	
40206R3	52770-3	
40209R	52152	
40209R3	52153	
40209Y	52153	
40209Y3	52153-3	
40215R	52672	
40215R3	52672-3	
40222R	52772+92511	
40222R3	52772-3+92511-3	
40222Y	52773+92511	
40226R	52672+92511	
40229R	53612	
40229R3	53612-3	
40229Y	52923+92511	
40232R	52152+43702	
40233R	52772+92512	
40233R3	52772-3+92512-3	
40233Y	52773+92512	
40233Y3	52772-3+92512-3	

Truck-Lite PN	Grote Form, Fit and Function	Grote Fit and Function
40234R	52922+92512	
40234R3	52922-3+92512-3	
40237R	52152+92511	
40237Y	52153+92511	
4023Y106	52912	
40241R	52952	
40241Y	52953	
40242R	52592	
40242R3	52952-3	
40242Y	52953	
40242Y3	52953-3	
40244-3	62171-3	
40248R	52672	
40248R3	52672-3	
4024Y106	52902	
40258R	52772+92511	
40258R3	52772-3+92511-3	
40258Y	52773+92511	
40259R	52772+92512	
40262-3	62271-3+92512-3	
4027-3	50972-3	
40282R	52922	
40282R3	52922-3	
40282Y	52923	
40282Y3	52923-3	
40403-3	67150	
4050-3	G4002-3	
4050A	G4003	
4050A-3	G4003-3	
4051-3	G4022-3	
4051A	G4023	
4051A-3	G4023-3	
4060C	62691	
4060C-3	62691-3	
40700-3	91740	
40715-3		43642-3
40720-1		43572+92512
40720-3		43572-3+92512+3
40725-3	51090-3	
40756-3	51032-3	
40757-3	51022-3	
40898R	52952	
40898Y	52953	
4091A	52063	
4093A	52063	
41-3	40232-3	
41A	40233	
41A-3	40233-3	
41AD	40233-5	
41D	40232-5	
425WD		60011-5
426W	60011	
42722-3	43022-3	
43-3	40192-3	
433WD		60151-5
434WD	60151-5	
435W		60081
43A	40193	
43A-3	40193-3	
43AD		40193
43D		40192
44001Y	53413 + 91740 + 66815	
44001Y1		53413 + 91740 + 66815

TRUCK-LITE-TO-GROTE INTERCHANGE

Truck-Lite PN	Grote Form, Fit and Function	Grote Fit and Function
44001Y3	53413-3 + 91740-3 + 66815-3	
44002R	53312 + 91740 + 66815	
44002R1		53312 + 91740 + 66815
44002R3	53312-3 + 91740-3 + 66815-3	
44003Y	53413 + 91740 + 66815	
44003Y1		53413 + 91740 + 66815
44018Y	52163 + 91740 + 66815	
44021Y	53453	
44022R	53542	
44023Y		53323
44024Y		53323
44026R	53182	
44027Y		53543
44030R	53452	
44030R1		53452
44030R3	53452-3	
44032R	53272	
44032R1		53272
44032R3	53272-3	
44034R	53252+93683	
44036R	54032	
44036R1		54032
44036R3	54032-3	
44038R	54032	
44040C	65541	
44041C	62391 + 91740 + 66842	
44042C	61601	
44044C	62671	
44045C	62391 + 43343 + 66842	
44046C	61601	
44071Y	53553 + 91740 + 66815	
44082R	53312 + 91740 + 66815	
44092R	53552 + 91740 + 66815	
44092R3	53552-3 + 91740-3 + 66815-3	
44101R	77352	
44101Y	77353	
44102R	77352 + 91740 + 66815	
44102Y	77353 + 91740 + 66815	
44103R	77352+66815	
44103Y	77353+66815	
44104R	77352+66815	
44104Y	77353+66815	
44140C	62551 + 91740 + 66861	
44141C	62391 + 917400 + 66842	
44144C	62671+66842	
44145C	62391 + 43343 + 66842	

Truck-Lite PN	Grote Form, Fit and Function	Grote Fit and Function
44146C	62391 + 92512 + 66842	
44180C	62101	
44181C		62101 + 92511 + 66862
44182C		62101 + 92512 + 66862
44184C		62101 + 91740 + 66862
44201Y	53413	
44202R	53313	
44203Y	53313	
44203Y3	53313-3	
44205C	62551	
44206C	62671	
44207C	61581	
44211R	77352	
44211Y	77353	
44212R	77352	
44212Y	77353	
44213R	77352	
44213Y	77353	
44214R	77352	
44214Y	77353	
44216R	77192	
44216Y	77193	
44221Y	55123	
44222R	53542	
44223Y		53323
44224Y		53323
44226R	53182	
44226R3	53182-3	
44227Y	55133	
44231Y	55113	
44233Y	53323	
44235C	62671	
44236C	62391+43343	
44237C	61601	
44239C	62391+92510	
44240C	62391+92512	
44253R	52162	
44266R	52162+92512	
44273Y	52163	
44276Y	522163+92512	
44302R	53552	
44302R3	53552-3	
44308C	61141	
44322R	54032	
44322R3	54032-3	
44326R	54022	
44326R3	54022-3	
44328R		54032
44334R	54042	
44339C	61971	
44344C		62101 + 92511 + 66862
44345C		62101 + 92510 + 66862
44346C		62101 + 92512 + 66862
44347C		62101 + 67006
44348C		62101 + 66862 + 92512
44349C		62101 + 92510 + 66862
44350C		62101
44350R	53532	

Truck-Lite PN	Grote Form, Fit and Function	Grote Fit and Function
44351R	54342	
44351R3	54342-3	
44353R	53552	
44355R	53532	
44356R	53552 + 92510 + 66862	
44357R	54342+92510	
44359R	53272 + 92510 + 66862	
44360R	53532+92510	
44361R	53552 + 92511 + 66862	
44362R	54342 + 92511 + 67090	
44363R	53552 + 92511 + 66862	
44366R	53272	
44390R	65432-4	
44390R1	65432-4	
44705-1	43343	
44705-3	43343-3	
44871Y	53313	
44877Y		53313+92511
44878Y		53313+92511
44881Y	53413	
44882R	53312	
44883R	53542	
44883R3	53542-3	
44887Y	53543	
44888Y	55133	
44953R	53532+92512	
44954R		53532+92511
44956R		53532+92511
44957R		53532+92511
44958R	53272	
44959R	53532	
44960R		53532
44972R		53532
44973R		53532
44974R	53252	
44975R		53532+92510
44976R		53532+92510
44978R		53532+92510
44979R		53532+92510
44980R	53282	
44982R	53552	
44982R3	53552-3	
44983R	54032	
44986R	54022	
44988R	53552+92510	
44990C		62101
44991C		62101+92511
44992C		62101+92512
45001R	52232 + 94180 + 67000	
45001Y	52233 + 94180 + 67000	
45002R	52232 + 94180 + 67000	
45002Y	52233 + 94180 + 67000	
45021Y	52203 + 94180 + 67000	
45021Y3	52203-3 + 94180-3 + 67000-3	
45022R	52232 + 94180 + 67000	

Technical Information

Information Technique Información técnica

TRUCK-LITE-TO-GROTE INTERCHANGE

Truck-Lite PN	Grote Form, Fit and Function	Grote Fit and Function
45022R3	52232-3 + 94180-3 + 67000-3	
45032R		G4502+67000
45071Y	G4503	
45071Y3	G4503-3	
45072R	G4502	
45072R3	G4502-3	
45201R	52232	
45201Y	52233	
45202R	52202	
45202R3	52202-3	
45202Y	52203	
45202Y3	52203-3	
45251Y	52233	
45252R	52202	
45262R	G4502	
45272R	G4502	
45-3	40072-3	
4550-3	G4502-3	
4550A	G4503	
4550A-3	G4503-3	
45700-3	94180-3	
45701-3	94180-3	
45A	40073	
45A-3	40073-3	
45ATD	40073-5	
45TD	40072-5	
47-3	40052-3	
47A	40053	
47A-3	40053-3	
47ATD	40053-3	
47TD	40052-5	
49202R	53102	
49202R3	53102-3	
49203C	62211	
49203C3	62211-3	
5013K	53712	
5015K	53722	
5023Y102	53712	
50385 0336	66101	
52-3	41012-3	
52A	41013	
52A-3	41013-3	
530DK	65300-5	
5315Y101	53702	
5316Y101	53712	
533DK	65370-5	
534-3	52312-3	
534D	52312-5	
535-3	52302-3	
535D	52302-5	
537A	44370	
540D	50852-5	
54-3	41032-3	
548-3	53132-3	
548D	53132-5	
549AD	53133-5	
549SWD	61491-5	
54A	41033	
54A-3	41033-3	
54ATD	41033-5	
54TD	41032-5	
55555-1	65312	
57-3		40152-3

Truck-Lite PN	Grote Form, Fit and Function	Grote Fit and Function
57A		40153
57A-3		40153-3
580DK	65402-4	
580K	65402-4	
60001R	53092	
60001Y	53093	
60002R	53092	
60002R1		53092
60002R3	53092-3	
60002Y	53093	
60002Y3	53092-3	
60004C	62231	
60015R		52512 + 92420 + 67000
60015Y	52253	
60015Y1		52253
60015Y3	52253-3	
60022Y	52573	
60022Y3	52573-3	
60050R	53122	
60050R1		53122
60050R3	53122-3	
60052R	53592	
60052R1		53592
60056R	53622	
60072Y	53593	
60072Y1		53593
60075Y	53123	
60075Y1		53123
60083R	53092	
60083Y	53093	
60084C	62231	
60085R	53122	
60092C	62521 + 92420 + 67010	
60094Y	53123	
60094Y1		53123
60096Y	53593	
60096Y1		53593
60097Y	53623	
60115Y	52323 + 92400 + 67002	
60115Y1		52323 + 92400 + 67002
60117Y		52353
60117Y1		52353
60120R	77362 + 92420 + 66815	
60120Y	77363 + 92420 + 66815	
60120Y1		77363 + 92420 + 66815
60122R	77362 + 92420 + 66815	
60122Y	77363 + 92420 + 66815	
60122Y1		77363 + 92420 + 66815
60124R	77362+66815	
60124Y	77363+66815	
60124Y1		77363+66815
60126R	77362+66815	
60126Y	77363+66815	
60126Y1		77363+66815
60201R	55772	
60201R3	55772-3	

Truck-Lite PN	Grote Form, Fit and Function	Grote Fit and Function
60201Y	55773	
60201Y3	55773-3	
60202R	52892	
60202R1	52892-5	
60202R3	52892-3	
60202RB	52892-1	
60202Y	52893	
60202Y3	52893-3	
60204C	62231	
60204C3	62231-3	
60215R	52512	
60215R3	52512-3	
60215Y	52193	
60215Y3	52193-3	
60250R	53962	
60250R3	53962-3	
60252R	53592	
60252R3	53592-3	
60253R	52072	
60255Y	52073	
60256R	53622	
60264R	52072	
60272Y	53593	
60275Y	53963	
60276Y	53623	
60283R	52182	
60283R3	52182-3	
60283Y	52183	
60283Y3	52183-3	
60284C	62521	
60284C3	62521-3	
60290Y	53963	
60291Y	52593	
60291Y3	52593-3	
60292Y	53623	
60298Y		52073+43220
60315Y	52323	
60317Y		52353
60360R	77362	
60360Y	77363	
60362R	77362	
60362Y	77363	
60364R	77362+43222	
60364Y	77363+43222	
60366R	77362+43222	
60366Y	77363+43222	
6050-3	G6002-3	
6050A	G6003	
6050A-3	G6003-3	
6051-3	G6012-3	
6051A	G6013	
6051A-3	G6013-3	
6060C	62751	
6060C-3	62751-3	
60700-3	92420-3	
60720-1		43362
60720-3	43362-3	
60722-3		43362-3
60802R	52892	
60802Y	52893	
60804C	62231	
60872Y	53593	
60885R	53962	
60891Y	53963	
60892Y	53963	
610W	63151-5	

TRUCK-LITE-TO-GROTE INTERCHANGE

Truck-Lite PN	Grote Form, Fit and Function	Grote Fit and Function
610WD	63151-5	
620H	64930	
620W	64931	
620W-3	64931-3	
620W-4	64921	
627WD	63231-5	
628WD	63221-5	
629WD	63211-5	
630H	64940	
630W	64471	
630W-3	64471-3	
630W-4	64491	
632W	64941	
633W	64941	
6500A	56073	
6501A	56083	
6503A	56072	
6600A		77693
6601A		77713
6602PS	99880	
66050R	54162 + 92420 + 66815	
66050R1		54162 + 92420 + 66815
66052R	54162 + 43220 + 66815	
66052R1		54162 + 43220 + 66815
66054R		54162 + 43220 + 66816
66056R	54162 + 43222 + 66815	
6606PS	99080	
66082R	54162 + 43220 + 66816	
66085R	54162 + 92420 + 66815	
66205C	62061	
66205C3	62061-3	
66206C	62061+43222	
66206C3	62061-3+43222-3	
66250R	54162	
66252R	54162 + 43220 + 66815	
66254R		54162 + 43220 + 66815
66256R	54162 + 43222 + 66815	
6660PS	99880	
66882R	54162 + 43220 + 66815	
66885R	54162	
6810A	77693	
6811A	77713	
6859A	76083	
69003C	62261	
69202Y	52533	
69202Y3	52533-3	
69203C	62241	
69203C3	62241-3	
70300-1		56000
70310R	50642	
70330R	55232	

Truck-Lite PN	Grote Form, Fit and Function	Grote Fit and Function
70330Y	55243	
7038D	12201-5	
7039D	12004-5	
7044-3	12014-3	
798-3	71422-3	
80162C	61921	
80164C		61921
80250C	61881	
80250C3	61881-3	
80251C	61611	
80251C3	61611-3	
80253C		61611
80302R	50222	
80302R1		50222
80302R3	50222-3	
80322R	50542	
80324R	50532	
80334R	50232	
80334R3	50232-5	
80335R	52522	
80336R	52612	
80336R1	50232-5	
80339R	50502	
80344-3	62151-3	
80350-3	61821-3	
80351-1		61831
80351-3	61831-3	
80360-1	64931-5	
80360-3	64931-3	
80360-B	64931-1	
80394-3	63231-3	
80396-3	64891-3	
80423C	60311	
80462R	50892	
80463R	50882	
80482-1	61091-5	
80800-3	63451-3	
80893-3		63451-4
80893-P		63451-4
81300R	50232	
81301R	52522	
81312Y		55430+91513
81360-3		63561-3
81360-P		63561-3
81374-3		63561-3
81380-3	63551-3	
8861-3	99912-3	
8861A	99913	
8861A-3	99913-3	
8900A	94093	
8933A	90203	
9004A	90303	
9004W	90301	
9007A	91963	
9007A-3	91963-3	
9007B	91965	
9007G	91964	
9007W	91961	
9016A	91583	
9016W	91581	
9029A	90013	
90325Y	56083	
90326R	78322	
90326Y	78323	
9079A	91503	
9082A	93253	

Truck-Lite PN	Grote Form, Fit and Function	Grote Fit and Function
9087A	90142	
9093A	90123	
91002R	50132	
9101-3	68130	
9102-3	68170	
91241Y	55983	
91242R	55982	
91243Y	55993	
91244R	55992	
91271Y	55983	
91271Y3	55983-3	
91272R	53422	
91272R3	53422-3	
91273Y	55993	
91273Y3	55993-3	
91274R	55992	
91275R		55992
91276Y		55983
9179-3	43673-3	
9179D	43673-5	
91802R	50132	
92100-1		53582
92513Y	77453	
92516Y	77641	
92522Y	77753	
92523Y		77753
92524Y	76803	
92525B	76805+43420	
92525Y	76803+43420	
92534Y	77123	
92539Y		77123
92551Y	77263	
92553Y	77193	
92554Y	76083	
92565Y	HELP	
92600Y	76223	
92602B	76035	
92602Y	76033	
92642Y	76803	
92685Y	76823	
92687Y	78473	
92900-1	73040-5	
92914-1		73220
92WD	62021	
9341B	90235	
9371A	92693	
9371W	92691	
9380SWD	61091-5	
9380W		61091
94706-3	66860-3	
94707-3	66861-3	
94902-3	67001-3	
94924-3	67001-3	
94925-3	67010-3	
94926-3	67000-3	
94938-3	84-1000	
94940-3	68380-3	
94992-3	67014-3	
94993-3	67090-3	
96106-3	66842-3	
96107-3	67002-3	
96108-3	67013-3	
9680A	78980	
97100-1		87890
97101-1		87891
97101-3	87891-3	
97231-3	44010-3	

Technical Information

Information Technique Información técnica

TRUCK-LITE-TO-GROTE INTERCHANGE

97232-3	44010-3	
97300-1	44040	
97803-3	16033-3	
97805-3	12113-3	
97944-1	99170	
97944-3	99170-1	
97960-1		43901
97960-3	43901-3	
98003R	40132	
98003R1	40132-5	
98003R3	40132-3	
98003Y	40133	
98003Y1	40133-5	
98003Y3	40133-3	
98006R	40152	
98006R3	40152-3	
98006Y	40153	
98006Y3	40153-3	
98031R	41042	
98031R3	41042-3	
98031Y	41043	
98031Y3	41043-3	
98035R		40302

98035R3		40302-3
98035Y		40303
98035Y3		40303-3
98100-3	40641-3	
98101-3	40650-3	
98104-1	40650-5	
98104-3	40650-3	
98110-3	41093-3	
98127-3	41160-3	
98153-3	41121	
98154R	41122	
98154R3	41122	
98175R	41142	
98175R3	41142-3	
98175Y	41143	
98175Y3	41143-3	
98176R	41152	
98176R3	41152-3	
98176Y	41153	
98176Y3	41153-3	
99007C	90761	
99007R	90762	
99007R3	90762	
99007Y	90763	
99008C	91311	
99008R	90012	

99008Y	90013	
99009R	90232	
99009Y	90233	
99034R	90162	
99034Y	90163	
99039B	90305	
99039R	90302	
99039Y	90303	
99041R	90152	
99041Y	90153	
99063R	99912	
99063Y	99913	
99067R	91682	
99067Y	91683	
99083R	91482	
99167Y	99863	
99168R	99842	
99168Y	99843	
99169R	99832	
99169Y	99833	
99170R	99802	
99170Y	99803	
99171R	99912	
99821R	99842	
99821Y	99843	

grote.com

For the fastest, most up-to-date resource for all Grote products and information, visit grote.com.



Discover resources, technical information, product literature and learn about new products. Our product catalog search, lets you search by part number or product category.

Grote LED Lighting Portfolio™

SUPERNOVA

High Performance

LED



SuperNova®

SuperNova® high-performance LED lamps:

- Are lightweight; the new NexGen™ lamps weigh 50% less than the major competitor lamps
- Require one-eighth the amperage needed to drive an incandescent lamp
- Include solid-brass terminals in male-pin and hard-shell configurations, for a more secure connection and maximum protection against corrosion
- Feature specially formulated encapsulant potting that seals out moisture and dirt, improving reliability and longevity
- Fit all Grote brackets and grommet mounting options
- Feature a hermetic lens-to-housing seal that prevents moisture intrusion
- Come with a 10-year warranty when configured with male-pin or hard-shell connectors and a 3-year warranty when configured with hardwire connectors



Hard Shell



Male Pin



High Style

LED



Hi Count®

Hi Count® high-style LED lamps:

- Are the highest visibility LED lamps around
- Offer premium styling and maximum diode count
- Come with standard female-pin terminations and stop / tail / turn lamps accept all popular incandescent plug-in connectors
- Feature built-in attitude
- Fit all popular mountings and grommets
- Come with a 2-year warranty



Female Pin

Grote **Select™**

High Value

LED



Grote Select™

Grote Select™ high-value LED lamps:

- Incorporate the latest LED technology and offer much longer life than incandescent lamps
- Provide faster light-on response times that increase stopping alert distances
- Have low power requirements, making more voltage available to other systems
- Require less maintenance on your electrical system
- Make use of existing wiring / pigtails for retrofit purposes
- Employ surface-mount electronics for cost-effective reliability
- Use specifically formulated encapsulated circuitry that provides protection against the elements
- Have hermetic lens-to-housing seal preventing moisture intrusion
- Look like incandescents, so they are not prone to theft
- Fit all Grote brackets and grommet mounting options
- Come with a 2-year warranty and Grote's exclusive Performance Advantage™ Plus Extended Warranty Program (when Grote Select™ are installed with Grote's UBS™ pigtail connectors)



Female Pin

CANADIAN MOTOR VEHICLE SAFETY STANDARDS & FEDERAL MOTOR VEHICLE SAFETY STANDARDS*

BASIC EQUIPMENT REQUIRED ON ALL TRAILERS

DESCRIPTION				MANDATORY REQUIREMENTS			
Area	Equipment	SAE Lens Code	Function	Quantity	Color	Location	Height from the Ground
1	Tail Lamps	T	Indicate vehicle's presence and width	Minimum 2	Red	On the rear - symmetrical as far apart as practicable	380 - 1,830 mm 15 - 72 inches
	Stop Lamps	S	Indicate braking	Minimum 2	Red	On the rear - symmetrical as far apart as practicable	380 - 1,830 mm 15 - 72 inches
	Rear Turn Signal Lamps	I	Indicate direction of turn	Minimum 2	Red or Yellow	On the rear - symmetrical as far apart as practicable	380 - 2,110 mm 15 - 83 inches
	Rear Reflex Reflectors	A	Indicate vehicle's presence and width	Minimum 2	Red	On the rear - symmetrical as far apart as practicable facing rearward	380 - 1,530 mm 15 - 60 inches
2	License Plate Lamp(s)	L	Illuminates license plate	Minimum 1	White	On the rear - above or at the sides of license plate	No requirement
3	Rear Side Marker Lamps	P2, PC* or P3, PC2*	Front and rear side marker lamps / side reflex reflectors indicate vehicle's presence and length	Minimum 2	Red	Each side at rear as far back as practicable	380 - 1,530 mm 15 - 60 inches no max. for veh. under 2,032 mm (80 inches) wide
	Rear Side Reflex Reflectors	A		Minimum 2	Red	Each side at rear as far back as practicable facing sideward	380 - 1,530 mm 15 - 60 inches
4a	Front Side Marker Lamps	P2, PC* or P3, PC2*		Minimum 2	Yellow	Each side at front as far forward as practicable	380 mm minimum 15 inches minimum
4b	Front Side Reflex Reflectors	A		Minimum 2	Yellow	Each side at front as far forward as practicable facing sideward	380 - 1,530 mm 15 - 60 inches

ADDITIONAL EQUIPMENT FOR TRAILERS EXCEEDING THE FOLLOWING PARAMETERS Length 9.1 m (30 ft) or longer

5a	Intermediate Side Marker Lamps	P2 or P3	Indicate presence of a long vehicle	Minimum 2	Yellow	Each side near center facing sideward	380 mm minimum 15 inches minimum
5b	Intermediate Side Reflex Reflectors	A	Indicate presence of a long vehicle	Minimum 2	Yellow	Each side near center facing sideward	380 - 1,530 mm 15 - 60 inches

Width 2,032 mm (80 inches) or wider

6	Rear Clearance Lamps	P2, PC* or P3, PC2*	Show vehicle's width MAY NOT be combined with tail lamps	Minimum 2	Red	At widest point - symmetrical on the rear or near the rear facing rearward	As high as practicable may be lower only if ID lamps are at the top
7	Rear Identification (ID) Lamps	P2 or P3	Indicate presence of a wide vehicle	Exactly 3	Red	On the rear - center horizontally spaced 150 mm (6 in) to 300 mm (12 in) apart facing rearward	In Canada: at the top - may be lower if door header narrower than 25 mm In USA: as high as practicable
8	Front Clearance Lamps	P2, PC* or P3, PC2*	Show vehicle's width	Minimum 2	Yellow	At widest point - symmetrical on the front or near the front facing forward	As high as practicable

Width 2,032 mm (80 inches) or wider AND GVWR 4,536 kg (10,000 lbs) or more

DESCRIPTION		MANDATORY REQUIREMENTS					
Area	Conspicuity Treatment	DOT Code	Quantity	Color	Location	Height	Options
9	Rear Upper Body Markings	DOT-C DOT-C2 DOT-C3 DOT-C4	Exactly 2 pairs of 300 mm long strips	White	On the rear upper corners facing rearward	At the top	Reflex reflectors may not be required if they are replaced in their required location with conspicuity treatment. Optional in Canada: Rear lower body and side conspicuity treatment may also be solid white, solid yellow, or white and yellow.
10	Bumper Bar Marking		Continuous	Red/White	On the rear bumper bar's horizontal element full width - facing rearward	No requirement	
11	Rear Lower Body Marking		Continuous	Red/White (See options)	On the rear full width of the vehicle facing rearward	As horizontal as practicable and as close as practicable to the range of 375 to 1,525 mm from the ground	
12	Side Marking		See Location	Red/White (See options)	Each side - facing sideward continuous, or evenly spaced over minimum of 50% of length starts and ends as close to the front and rear of the vehicle as practicable	As horizontal as practicable and as close as practicable to the range of 375 to 1,525 mm from the ground	

* Photometrically certified at installation angle

** Not required on truck tractors

§ Vehicles less than 2,032 mm wide

†Vehicles 2,032 mm wide or wider

‡Vehicles less than 2,032 mm wide and 4,536 kg

IMPORTANT NOTE: Every lamp, reflex reflector, and conspicuity treatment must be permanently attached in the location specified and must comply with all applicable requirements prescribed for it by FMVSS/CMVSS 108. The face of any device on the front/rear and sides should be respectively perpendicular and parallel to the vehicle's centerline unless it is photometrically certified at installation angle. No part of the vehicle

shall prevent any device from meeting its prescribed requirements unless an auxiliary device meeting all prescribed requirements is installed.
IN CANADA: Manufacturers and importers of vehicles must have the proper certification test records demonstrating compliance of lighting components with all prescribed requirements.

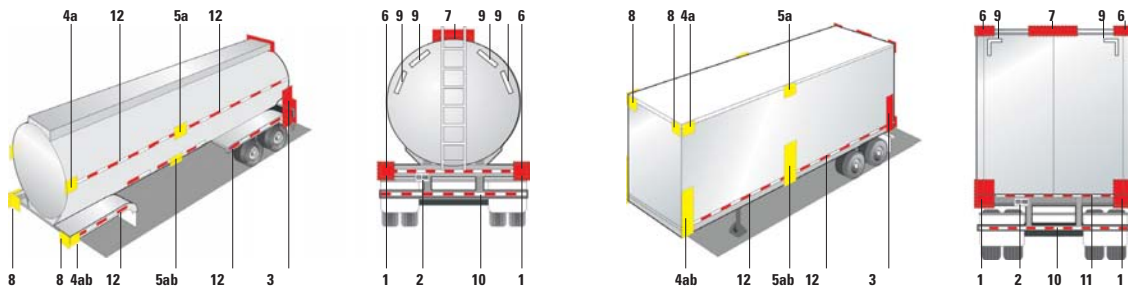

CANADIAN MOTOR VEHICLE SAFETY STANDARDS & FEDERAL MOTOR VEHICLE SAFETY STANDARDS*

BASIC EQUIPMENT REQUIRED ON ALL TRUCKS, BUSES & MPVs

DESCRIPTION				MANDATORY REQUIREMENTS			
Area	Equipment	SAE Lens Code	Function	Quantity	Color	Location	Height from the Ground
1	Headlamps - Lower Beam US requires DOT lettering on lens US & Canada - light source code required on lens	H, HR	Forward road illumination	Minimum 2	White	On the front - Symmetrical As far apart as practicable If 4 lamp system - outboard or above upper beams	560 - 1,370 mm 22 - 54 inches
	Headlamps - Upper Beam US requires DOT lettering on lens US & Canada - light source code required on lens	H, HR	Forward road illumination	Minimum 2	White	On the front - Symmetrical If 4 lamp system - inboard or below lower beams.	560 - 1,370 mm 22 - 54 inches
	Parking Lamps §	P	Indicate parked vehicle	Minimum 2	White or Yellow	On the front - Symmetrical As far apart as practicable	380 - 1,530 mm 15 - 60 inches
	Daytime Running Lamps (DRL) Canada - Required US - Optional (US requires "DRL" lettering on lens if not headlamp)	Y2	Indicate in use vehicle	Minimum 2	White or Yellow	On the front - Symmetrical As far apart as practicable	380 mm minimum 15 inches minimum Max. depends on type of DRL
	Front Turn Signal / Hazard Warning Lamps	I	Indicate direction of turn / identify disabled vehicle	Minimum 2	Yellow	On the front - Symmetrical As far apart as practicable	380 - 2,110 mm 15 - 83 inches
2	Front Clearance Lampst	P2, PC* or P3, PC2*	Show vehicle's width	Minimum 2	Yellow	At widest point - symmetrical on the front or near the front facing forward	As high as practicable
3	Front Identification Lamps (ID)t	P2 or P3	Indicate presence of a wide vehicle	Exactly 3	Yellow	On the front - center horizontally spaced 150 mm (6 in) to 300 mm (12 in) apart	As high as practicable or on top of the cab
4a	Front Side Marker Lamps	P2, PC*, P3, PC2*	Front and rear side marker lamps / side reflex reflector indicate vehicle's presence and length	Minimum 2	Yellow	Each side at front as far forward as practicable	380 mm minimum 15 inches minimum
4b	Front Side Reflex Reflectors	A		Minimum 2	Yellow	At front - symmetrical as far forward as practicable facing sideward	380 - 1,530 mm 15 - 60 inches
5a	Rear Side Marker Lamps**	P2, PC* or P3, PC2*		Minimum 2	Red	Each side at rear as far back as practicable	380 mm minimum 15 inches minimum
5b	Rear Side Reflex Reflectors**	A		Minimum 2	Red	Each side at rear as far back as practicable facing sideward	380-1,530 mm 15 - 60 inches
6	Rear Clearance Lamps** †	P2, PC* or P3, PC2*		Show vehicle's width, MAY NOT be combined with tail lamps	Minimum 2	Red	At widest point - symmetrical on the rear or near the rear facing rearward
7	Rear Identification (ID) Lamps** †	P2 or P3	Indicate presence of a wide vehicle	Exactly 3	Red	On the rear - center horizontally spaced 150 mm (6 in) to 300 mm (12 in) apart facing rearward	In Canada: at the top - lower if door header narrower than 25 mm In USA: as high as practicable
8	Tail Lamps	T	Indicate vehicle's presence and width	Minimum 2	Red	On the rear - symmetrical As far apart as practicable	380 - 1,830 mm 15 - 72 inches
	Stop Lamps	S	Indicate braking	Minimum 2	Red	On the rear - symmetrical As far apart as practicable	380 - 1,830 mm 15 - 72 inches
	Rear Turn Signal/Hazard Warning Lamps	I	Indicate direction of turn / identify disabled vehicle	Minimum 2	Red or yellow	On the rear - symmetrical As far apart as practicable	380 - 2,110 mm 15 - 83 inches
	Rear Reflex Reflectors	A	Show vehicle's presence and width	Minimum 2	Red	On the rear - symmetrical As far apart as practicable	380 - 1,1530 mm 15 - 60 inches
9	Backup Lamp	R	Illuminates ground behind the vehicle and alert road users	Minimum 1	White	Rear	No requirement
10	License Plate Lamp(s)	L	Illuminates license plate	Minimum 1	White	On the rear - above or at the sides of license plate	No requirement
11	Center High Mounted Stop Lamp ‡	U3	Indicates braking	1	Red	On the rear - centerline of the vehicle	860 mm minimum 34 inches minimum

ADDITIONAL EQUIPMENT FOR SPECIFIC VEHICLES - VEHICLES 9.1 m (30 ft.) LONG OR LONGER

12a	Intermediate Side Marker Lamps	P2 or P3	Indicate presence of a long vehicle	Minimum 2	Yellow	Each side near center	380 mm minimum 15 inches minimum
12b	Intermediate Side Reflex Reflectors	A	Indicate presence of a long vehicle	Minimum 2	Yellow	Each side near center facing sideward	380 - 1,1530 mm 15 - 60 inches

TRUCK TRACTORS

DESCRIPTION		MANDATORY REQUIREMENTS					
Area	Conspicuity Treatment	DOT Code	Quantity	Color	Location	Height	Options
13	Rear Upper Body Markings	DOT-C DOT-C2 DOT-C3 DOT-C4	Exactly 2 pairs of 300 mm long strips	White	Rear upper corners of cab facing rearward	As high as practicable excluding fairings	
14	Rear Marking		Exactly 2 sections of min. 600 mm each	Red/White	Rear - facing rearward - on mud flap brackets, or within 300 mm below the top of mud flaps	As horizontal as practicable and not higher than 1,525 mm from the ground	If mud flaps not used - on the cab or frame mounted brackets

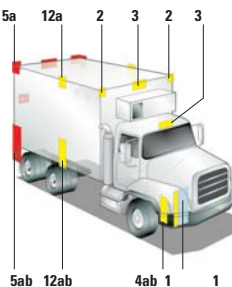
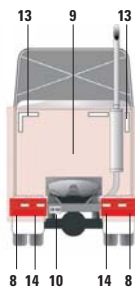
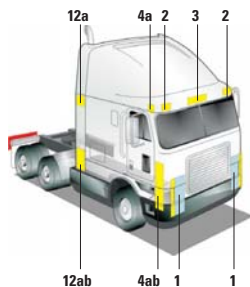

Work Lamps and Light Quality that

At Grote Industries, we know that lighting is essential to productivity, and we've spent countless hours studying the difference between "brightly lit" and "optimally lit" environments. We understand the relationship between lighting and human and vehicle performance. Our engineers have designed the entire array of Grote LED WhiteLight™ Work Lamps to provide maximum visual comfort while reducing fatigue, stress and operator error – all while being some of the most durable and reliable lamps on the planet.

It's not just a matter of building a bright light – it's a dedication to delivering the right light that continues to set Grote apart. We call what we do "ergonomic lighting" because we literally engineer light to meet the specifications of unique environments – optimizing the lighting conditions for the operations to be performed within them. So whether you're guiding a vehicle over complex terrain through airborne dust, maneuvering through a dark field or simply trying to illuminate the task at hand, there's a Grote LED WhiteLight™ Work Lamp for you.



OE LAMPS VS. L



TRILLIANT® 36 LED WHITELIGHT™ WITH MOUNTING BRACKET

The Trilliant 36 LED WhiteLight™ with Mounting Bracket was created to give the user the ability to employ bright, LED WhiteLight™ when a housing is not desired. The lamp is designed to allow 180-degrees of vertical rotation, takes up little space and can be mounted virtually anywhere. The lamp assembly comes with a Packard-style connector and pigtail. Replaceable UV, hard-coated, polycarbonate lenses are also a standard feature on the lamp.

63861-5 10V-30V TractorPlus™
63871-5 10V-30V Wide Flood



TRILLIANT® 36 LED WHITELIGHT™ CONVERSION BULB

The Trilliant 36 LED WhiteLight™ Conversion Bulb turns any PAR 36 incandescent lamp into an LED WhiteLight™ Lamp. Users can upgrade an existing incandescent or halogen lamp, transforming it into a brilliant 900-lumen LED WhiteLight™ lamp that lasts longer, shines brighter and delivers better value. The bulbs come in a wide flood beam pattern and Grote's new TractorPlus™ beam pattern. Each bulb is manufactured with a replaceable UV, hard-coated, polycarbonate lens. The lenses are easily interchanged and conversion from a wide flood to TractorPlus™ lens can be accomplished within moments.

63821-5 10V-30V TractorPlus™
63831-5 10V-30V Wide Flood

Give You a Performance Advantage™



LED WHITELIGHT™

Beam Patterns

SPOT

Piercing beam of pure focused LED WhiteLight™. Used for illuminating objects in the distance.



FLOOD

Practical beam pattern used for broad variety of applications like construction, agriculture and loading.



TRAPEZOID

Controlled beam pattern used for near-field forward lighting in off-highway applications. Provides a wide angle beam giving great lateral illumination.



WIDE FLOOD

Widest beam pattern available. Used for a variety of applications like road construction and general scene lighting.



NOTE: Comparison photographs were shot using the same camera at the same camera settings. There were NO alterations in color, contrast or brightness.



LED

TRILLIANT® MINI WORK LAMP

An excellent work lamp for any instance where a high-output illumination source is needed. Like its big brother, this low-power, long-life lamp delivers beam pattern evenness and color temperature that produce a contrast most like that of natural sunlight.

63601 - Spot	63731 - 24V Spot
63611 - Flood	63741 - 24V Flood
63621 - Trapezoid	63751 - 24V Trapezoid



LED

TRILLIANT®

This hard-working, rugged, high-output lamp uses Grote's proven premier LED WhiteLight™ technology. The light output of the Trilliant® rivals HID's, eclipses halogen competitors and provides beam pattern evenness and color temperature that produce a contrast most like that of natural sunlight. Three replaceable lens patterns are available, and can be easily changed out as needed. Add Grote's unique mounting bracket for enhanced directional control.

63571 - Spot	63671 - 24V Spot	94580 - Spot Lens
63581 - Flood	63681 - 24V Flood	94600 - Flood Lens
63591 - Trapezoid	63691 - 24V Trapezoid	94590 - Trapezoid Lens
63761 - Wide Flood	63771 - 24V Wide Flood	43652 - Mounting Bracket

9 Common Causes of Failure



VIBRATION

Broken lamp filaments are one of the most common problems caused by vibration, but they also can lead to the abrasion of mating surfaces, which cause connectors and splices to fail.

To minimize vibration problems, make certain that all wires and connectors are secured appropriately. Always secure the wiring as it exits the connector. Use cushioned mountings for lamps in applications where vibration is excessive.



MOISTURE AND CORROSION

Condensed water droplets inside a lens or corrosion around a lamp socket are sure signs that moisture has penetrated the system.

Water can enter the system through ineffective wire seals, unprotected splices, unsealed crimps and connectors and non-mating seals.

When making repairs, don't replace a sealed system with unsealed components. Make certain that connector seals are in place and undamaged. Inspect them carefully for cuts, tears and punctures.

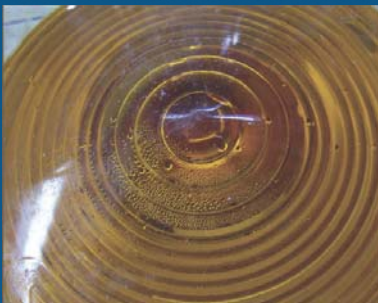

CHEMICAL DAMAGE

Continuous exposure to many of the common chemicals found in and around trucks can cause plastics to swell, crack, soften or otherwise become degraded. Diesel fuel and hot engine oil are the main culprits.

To minimize the effects of chemicals, inspect the wiring for signs of degradation. If it is occurring in an area that is generally free of contamination, check for leaky hoses, gaskets or fittings and repair if damaged or leaking.

To avoid damage from chemicals, don't run wiring in areas where the chance for continuous exposure is likely, such as under fuel lines and filters.



ABRASION

Abrasion occurs when wires or wire wraps are allowed to run against frame members or other abrasive surfaces. Once the insulation is worn away, bare conductors may contact a ground surface and create a grounded circuit. Or, it could cause wear to the point of fracture resulting in an open circuit.

Using the proper routing and coverings will help to prevent wear areas and abrasive damage.

Worn coverings such as loom, convoluted tubing or spiral wrap should be replaced if they are no longer providing sufficient protection for the wires inside.



EXTREME TEMP

A variety of conditions lead to extreme temperature build-up that can damage lighting and wiring. These include leaving a trailer's tail lights on when the trailer is backed up to a dock and airflow around the lights is prohibited.

When lights have been damaged from heat buildup, the lenses are often bubbled and misshapen. Where extreme temperatures can't be avoided, special heat-resistant wires and materials should be used.

in Truck Wiring and Lighting



IMPACT

Lighting and wiring must be protected from the impact of rocks, gravel and other road debris. A major impact can cause enough damage to require extensive repairs. Smaller, more frequent impacts over time may deliver equally extensive damage. Damage from impacts can cause problems although the wires are contained in a loom or other covering. During inspection, always check for damage from impacts and replace any wiring or lights that appear to be damaged. Make certain that the replacement parts are equivalent to or better than the original.



FLEXING

Wiring in a truck often must make sharp turns around corners, as well as subjected to constant flexing where doors or hoods are opened and closed repeatedly.

To prevent wire damage from repeated flexing, avoid tight radius turns. Make sure that the wire is not snagged or stressed at its maximum extension. Also, make certain that the wire moves smoothly through its flexing cycle and doesn't rub or scrape against adjacent components.



TENSILE LOADS

Wiring should not be considered an appropriate load-bearing component. It's easy to exceed the designed load limit by inadvertently installing wires under tension or snagging a section of wire on one of the moving parts. Using a wire bundle as a handhold or step can destroy the integrity of the conductor and its connections. So can the weight of accumulated ice, snow, mud and other materials.

Each of these points must be considered carefully when routing wires in a wiring harness.



GRIT AND SAND

Accumulation of abrasive materials can lead to damage, especially when combined with vibration. If gritty materials enter connections, they can accelerate the wear on contact points causing interruption of the circuit and failure of devices. Sand and grit also can attract and hold moisture, creating conditions conducive to corrosion. In some cases, sand and grit may work their way inside protective coverings and abrade the insulation of wires running through them if there is relative motion between the covering and the wire.

One of the ways of reducing sand and grit buildup is to eliminate abrasive materials in the areas where wiring is present. Another way is to seal openings on protective coverings to keep gritty materials from entering.

For more information, visit www.grote.com

Grote

The first name in vehicle
safety systems®



William D. Grote, Founder
Grote Industries 1901

A family's commitment to the vehicle and transportation lighting industry, spanning more than four generations

Just like many of the distributors, fleets and OEM's Grote Industries serves, we're a family-owned business. Like a number of our customers, we're proud of our family's multi-generational commitment to the transportation industry, reaching back more than a century. If you know the Grote family, you also know that the vehicle lighting business is not just a job to us, it's something that's folded into our family's culture – part of our very DNA. We're fond of saying that "lighting is in our blood" and we're only half kidding.

Unlike many institutionally-owned companies, we're able to draw on our family's time-honored values, built upon our tradition of service to the industry and our fierce entrepreneurial spirit. We're thankful for the visionary legacy of our predecessors and because of it, we can't help but to see the past, present and future of the lighting industry in a different context from those who simply find themselves working in the lighting business.

Founded on the principles of solid customer relationships, continuous innovation and exceptional product performance, Grote is committed to propelling itself and its industry forward, with inventive products and challenging ideas.

As a corporation, our family's culture extends to our entire organization, around the globe and particularly to our customer-facing staff. Grote is not sales oriented, we're not engineering oriented – we're relationship oriented and we're working hard every day to uphold our reputation and continue to earn your trust.

The Grote family has played a prominent role in shaping the vehicle lighting industry. We are deeply and personally engaged today, as we will be in the future, to make the kind of brave choices and bold decisions that will help move the vehicle lighting industry ahead and into an even brighter tomorrow.

Grote Industries, Inc.
2600 Lanier Drive
Madison, Indiana 47250
USA
Phone: 812-273-2121
Phone: 800-628-0809
Fax: 812-265-8440
Email: safety@grote.com

Grote Manufacturing, Ltd.
230 Travail Road
Markham, Ontario L3S 3J1
Canada
Phone: 905-209-9744
Phone: 800-268-5612
Fax: 905-209-9757
Fax: 800-267-9024
Email: canada@grote.com

**Grote Industrias de México,
S.A. DE C.V**
Ave. Rogelio González Caballero 225
Parque Industrial Stiva Aeropuerto
Apodaca, Nuevo León
México
C. P. 66600
Phone: 011 (52) 81-8262-4400
Fax: 011 (52) 81-8262-4404
Email: mexico@grote.com

Grote Industries Europe GmbH
Am Schaidweg 3
D-94559 Niederwinkling
Germany
Phone: +49 9962 / 20008-0
Email: europe@grote.com

56-9513-32

grote.com



The first name in vehicle
safety systems®